

# DRAFT FINAL REPORT VOLUME 1

## YALE MAINTENANCE FACILITY ASSESSMENT

City Of Albuquerque  
ABQ Ride  
Albuquerque, New Mexico



**PARSONS  
BRINCKERHOFF**

June 2015



# TABLE OF CONTENTS

---

## **VOLUME I**

### **Executive Summary**

Acknowledgments .....	I
Background.....	II
Facility Condition Assessment.....	III
Space Needs .....	IV
Concept Design .....	V
Estimate of Probable Construction Cost .....	VI

### **Chapter 1: Existing Site and Facility Review**

Background.....	1.1
Existing Transit Vehicle Flow.....	1.3
Exterior Bus Parking and Circulation .....	1.6
Maintenance Building.....	1.9
Fuel Island .....	1.25
Wash Building.....	1.27
Administration / Operations Building .....	1.30
Old Bus Garage.....	1.31
New Bus Storage Building .....	1.33
Old Sun Van Building .....	1.35
Historic Significance .....	1.36

### **Chapter 2: Design Criteria**

#### Section 1: General Considerations

Acknowledgments .....	2.1.1
Background.....	2.1.2
Introduction .....	2.1.3
Methodology .....	2.1.4
Daily Activities.....	2.1.6
On-Site Traffic Movement.....	2.1.7

#### Section 2: Space Needs Program

Introduction .....	2.2.1
Space Needs Program.....	2.2.3

#### Section 3: Functional Requirements

Introduction .....	2.3.1
Maintenance (Offices) .....	2.3.2
Maintenance (Bays & Shops) .....	2.3.17

# TABLE OF CONTENTS

---

Materials Management .....	2.3.60
Fuel & Wash .....	2.3.69
Facility Maintenance .....	2.3.88
Agency Vehicle Parking .....	2.3.98
Private Vehicle Parking .....	2.3.100
Other Site Areas .....	2.3.101
<b>Section 4: Site &amp; Building Requirements</b>	
Codes, Standards, and Permits .....	2.4.1
Civil.....	2.4.1
Landscape .....	2.4.3
Structural.....	2.4.5
Architectural.....	2.4.7
Mechanical.....	2.4.10
Electrical.....	2.4.13
Plumbing.....	2.4.18
Alternative Fuel Impacts .....	2.4.23
Security .....	2.4.26
Signage and Graphics .....	2.4.27
Waste Handling .....	2.4.27
Facility Maintenance .....	2.4.28
<b>Chapter 3: Concept Design</b>	
Introduction .....	3.1
Current Functions.....	3.1
Existing Yale Site Layout.....	3.2
Existing Yale Maintenance Facility Floor Plan.....	3.4
Proposed 40' Fixed Route Maintenance Facility Floor Plan.....	3.6
Proposed 60' Fixed Route Maintenance Facility Floor Plan.....	3.8
Options Breakdown.....	3.10
Option 1(X) .....	3.12
Option 1(E)A.....	3.14
Option 1(E)B.....	3.16
Option 1(E)C.....	3.18
Option 2(E)A.....	3.20
Option 2(E)B.....	3.22
Option 2(E)C.....	3.24
Option 2(N)A.....	3.26

# TABLE OF CONTENTS

---

Option 2(N)B.....	3.28
Option 2(N)C.....	3.30
Option 3(X) .....	3.32
Option 3(E)A.....	3.34
Option 3(E)B.....	3.36
Option 3(E)C.....	3.38
Options Assessment.....	3.41
Concept Design Option Analysis.....	3.42
Concept Design Sub-Option Analysis.....	3.43

## **VOLUME II**

### **Appendix A: Sign-In Sheets**

Sign-In Sheets.....	A.1
---------------------	-----

### **Appendix B: Fleet Inventory**

Fleet Inventory.....	B.1
----------------------	-----

### **Appendix C: Component Data**

Engine / Transmission Storage .....	C.1
Component Rebuild Analysis .....	C.2

### **Appendix D: Fleet Projections**

Fleet Projections.....	D.1
------------------------	-----

### **Appendix E: Capacity Analysis**

Capacity Analysis.....	E.1
------------------------	-----

### **Appendix F: Equipment Inventory**

Introduction.....	F.1
Equipment Inventory List.....	F.2
Equipment Photos.....	F.9

### **Appendix G: Preliminary Equipment List**

Introduction.....	G.1
Equipment List.....	G.3

# TABLE OF CONTENTS

---

THIS PAGE LEFT INTENTIONALLY BLANK



---

**EXECUTIVE SUMMARY**





# EXECUTIVE SUMMARY

---

## ACKNOWLEDGMENTS

The study team would like to thank the following ABQ Ride staff members that participated in the interviews for their time and input which made possible the development of the data contained herein.

### ABQ Ride

Bruce Rizzieri-----Director  
Annette Paez-----Associate Director

### Yale and Daytona Facilities

Jim Carrillo-----Maintenance Manager  
James Bird-----Asst. Maintenance Manager  
Nick Cordova-----Building Supervisor  
Randy Jiron-----Materials Manager  
Stan Low-----IT Division Manager  
Joe Saraphon-----IT Program Manager  
Steve Cordero-----Transit Service Specialist  
Stephen Meyehlein-----Shop Supervisor  
Jesus Torres-----Swing Shift Supervisor  
Jason Black-----Vehicle Service Supervisor

### Study Team

#### Parsons Brinckerhoff

Mark Probst-----Project Manager  
Mike Martin-----Planner

# EXECUTIVE SUMMARY

---

## BACKGROUND

ABQ RIDE provides transit service to the Albuquerque metropolitan area with 21 regular fixed routes, 15 commuter routes, 3 Rapid Ride routes, and one downtown circulator. This service is operated out of two facilities, the older Yale Maintenance and Operations Facility and the newer Daytona Maintenance and Operations Facility. The current fleet of fixed route transit buses is split between the two facilities, while the articulated bus and paratransit fleets operate only from the Daytona Facility. Note that CNG fueling is only available at the Yale Facility. The Daytona Facility operates 24 hours a day, 7 days a week and the Yale Facility operates 18 hours a day, 5 days a week.

The Yale Facility, at 601 Yale Boulevard, has been developed in phases over many years. ABQ RIDE wanted to evaluate the maintenance facility at Yale to determine how it can best be utilized to accommodate the current and projected fleet. The first step in the process is to conduct a maintenance facility assessment. The City engaged Parsons Brinckerhoff to develop the assessment and prepare a master plan for developing the facility. Note that this is intended to be an overall evaluation and not a detailed analysis of the building systems and components. The Yale Maintenance Facility Assessment addresses the following questions:

- What is the condition of the existing facility?
- What are the maintenance facility requirements to support the current and future fleet?
- Can the existing facility be upgraded / expanded to meet the projected needs?
- How can the Yale maintenance facility be best utilized to accommodate the current and projected fleet?
- What is the estimated cost to provide facilities that will meet the future needs?

**Determine how the Yale Facility can best be utilized to accommodate the current and projected fleet.**

The project includes the following facilities at the Yale Facility:

- Maintenance Facility
- Fuel and Wash Facilities
- Agency Vehicle Parking
- Employee / Visitor parking

Note: The Operations (Drivers) Facility is not part of the study.

A series of workshops were held to gather input from key ABQ Ride staff and to review and evaluate a range of options before selecting an approach that will allow ABQ Ride to continue to provide safe and reliable transit service to the Albuquerque metropolitan area.

Workshop #1 (February 2 to 4, 2015) focused on “programming” to

**A series of workshops were held to gather input from key ABQ Ride staff and develop buy-in to the concept design.**

# EXECUTIVE SUMMARY

---

identify the facility needs based on the projected fleet size and mix. The study team interviewed key staff to determine project goals, functional requirements, and operational characteristics. The condition of the existing facilities was evaluated and a detailed inventory of existing shop equipment was taken. The Facility Conditions, Design Criteria, and Equipment Inventory are documented in this report.

Workshop #2 (April 6 to 8, 2015) was dedicated to master planning and concept development. During this design charrette, a series of options were developed for the Yale Facility. The options were reviewed with key ABQ Ride staff and conceptual level site plans and floor plans were refined over the course of the workshop. The resulting plans became the basis for developing estimated probable cost of construction which are presented in a separate document. A preliminary equipment list was developed based on the space program, design criteria, and concept design. The equipment list includes existing equipment to be reused and a projected cost for the equipment. The list is presented in Volume 2 (Appendix) of this report.

## **FACILITY CONDITION ASSESSMENT**

The existing conditions are documented in Chapter 1 of this document along with ideas for addressing noted deficiencies. The primary deficiencies found at the Yale Facility were:

1. Bus circulation on the site is clockwise. Counter-clockwise traffic flow is safer and minimizes on-site accidents.
2. Pavement throughout the site is cracking badly and needs to be replaced.
3. The maintenance facility cannot be expanded to accommodate articulated buses.
4. The repair bays do not have adequate circulation between bays.
5. The parts storeroom is too small, resulting in parts and components being stored in multiple locations around the site (often unsecured).
6. Lighting and ventilation in the maintenance facility are poor.
7. Employee amenities (restrooms, locker rooms, lunch room) for maintenance and service staff are substandard and do not meet ADA requirements.
8. Supervisor office does not have a view of the shop.
9. The paint booth is undersized and body repair bays are too narrow.
10. Interior cleaning of buses is done in the yard with inadequate facilities.
11. The wash facilities (bus wash and chassis wash) are inadequate and the water reclamation system has been disconnected.
12. The Old Bus Garage should be demolished due to its condition.
13. When the New Bus Garage is full of buses, the western most buses stick out of the building because the building is too narrow.

**The existing site and facilities need major renovation and /or demolition and redevelopment due to their condition and placement on the site.**

# EXECUTIVE SUMMARY

---

## SPACE NEEDS

Table 1 shows the current and projected fleet size and mix to be accommodated.

**Table 1: Fleet Size and Mix**

	2015			2020	2025	2030
	Yale	Daytona	Total	Total	Total	Total
<b>Fixed Route (40')</b>	<b>78</b>	<b>52</b>	<b>130</b>	<b>140</b>	<b>150</b>	<b>160</b>
Diesel Hybrid	37	52	89			
CNG	41	0	41			
<b>Artic/BRT (60')</b>	<b>0</b>	<b>24</b>	<b>24</b>	<b>38</b>	<b>49</b>	<b>60</b>
<b>Paratransit</b>	<b>0</b>	<b>69</b>	<b>69</b>	<b>93</b>	<b>116</b>	<b>140</b>
<b>Total Revenue Vehicles</b>	<b>78</b>	<b>145</b>	<b>223</b>	<b>271</b>	<b>315</b>	<b>360</b>

The space needs were developed based on the 2030 fleet projections. Based on discussions with key ABQ Ride staff, it was determined that ideally the paratransit fleet would be split evenly between Yale and Daytona with 70 paratransit vehicles each. The articulated bus fleet could either be accommodated entirely at the Daytona Facility or split between the two facilities depending on deadhead cost analysis. The fixed route forty foot bus fleet should be split between the two facilities.

An analysis of the capacity of the current Yale and Daytona Facilities is presented in Volume 2, Appendix E of this report. The analysis is based on evaluation of the capacity of general repair bays, specialty bays, body repair and paint, fuel and wash. It shows that the Daytona Facility is capable of accommodating the entire projected articulated bus fleet. In addition, the analysis shows that the Daytona Facility could accommodate the entire existing fleet of 130 fixed route forty-foot buses, 24 fixed route sixty-foot articulated buses, and 69 paratransit vehicles if CNG fueling was added to the site. This provides ABQ Ride a unique opportunity to upgrade the Yale Facility before the projected fleet expansion beyond the year 2020.

The space needs shown in Table 2 (next page) include two options. Option 1 is for a fleet of 50 forty-foot buses and 70 paratransit vehicles and Option 2 is for a fleet of 20 forty-foot buses, 30 articulated buses, and 70 paratransit vehicles.

This space program, along with the design criteria outlined in Chapter 2 of this report, form the basis for the concepts developed and shown in Chapter 3.

# EXECUTIVE SUMMARY

**Table 2: Space Needs** (shown to the nearest 100 square feet)

	Yale Facility Options	
	Option 1	Option 2
<b>Maintenance</b>	<b>33,200</b>	<b>37,900</b>
<b>Materials Management</b>	5,700	5,700
<b>Fuel Facility</b>	6,700	6,700
<b>Wash Facility</b>	<b>8,400</b>	<b>8,800</b>
<b>Facility Maintenance</b>	<b>6,200</b>	<b>6,200</b>
<b>Total Building Area</b>	<b>60,200</b>	<b>65,300</b>

The detail breakdown for the space needs shown above is presented in Chapter 2 of this report.

## **CONCEPT DESIGN**

Alternative concepts were developed to meet the projected needs to the year 2030. Three main options were identified by the fleet mix.

- Option 1: 50 forty-foot fixed route buses + 70 paratransit vehicles
- Option 2: 20 forty-foot fixed route buses + 30 articulated buses + 70 paratransit buses
- Option 3: 140 paratransit buses

Each of these options was then broken down based on reuse of the existing facilities or orientation of a new Maintenance Facility on the site.

- Sub-Option X: Reuse the existing Maintenance Facility
- Sub-Option E: New Maintenance Facility on the east portion of the site.
- Sub-Options N: New Maintenance Facility on the north portion of the site.

Each options was further subdivided to show the impact of how Operations space would be provided:

- Sub-Option A: Reuse the existing Operations Building
- Sub-Option B: Build a new stand-alone Operations Building
- Sub-Option C: Include a new Operations space above the Maintenance Facility.

*Note that the existing Sun Van Building would be demolished in all design options.*

The layouts of all options are presented in Chapter 3 of this report.

# EXECUTIVE SUMMARY

---

The advantages and disadvantages of each option were identified and evaluated with key ABQ staff.

The primary findings of the conceptual design analysis were:

- The Yale site can accommodate any of the three fleet mix options. A detailed deadhead analysis was not in the scope of the study, but should be done to determine which fleet mix option is most cost effective.
- Reusing the existing maintenance facility severely limits what can be done on the site, therefore a new maintenance facility is recommended.
- After reviewing the options for a new maintenance facility, locating it on the east portion of the site results in the safest and most efficient traffic flow on-site.
- After reviewing the options for accommodating Operations, locating Operations on the second floor above Maintenance is the most advantageous solution.

The following options are recommended for further consideration:

**Option 1(E)C:** New Maintenance Facility on the east portion of the site for 50 forty-foot fixed route buses + 70 paratransit vehicles with Operations above Maintenance.

**Option 2(E)C:** New Maintenance Facility on the east portion of the site for 20 forty-foot fixed route buses + 30 articulated buses + 70 paratransit buses with Operations above Maintenance.

**Option 3(E)C:** New Maintenance Facility on the east portion of the site for 140 paratransit vehicles with Operations above Maintenance.

The layouts for these options are shown on the following pages.

## **ESTIMATE OF PROBABLE CONSTRUCTION COST**

An estimate of probable construction cost was developed for each option based on the conceptual layouts. The estimate is at a conceptual level and includes construction cost (site work, demolition, construction, renovation, furniture, and equipment), design cost, contingency, and escalation for 3 years to mid-point of construction.

The estimate is provided under separate cover.

The difference in cost between the three options recommended for further consideration is not significant. Selection of one of these options should be based on a deadhead analysis of fixed route and paratransit as part of the planning process. Note that deadhead analysis was not in the scope of this assessment.

# EXECUTIVE SUMMARY



DESIGN FLEET	
60	FIXED ROUTE 40'
70	PARATRANSIT 25'
130	TOTAL
20	NRV

LEGEND	
[Green Box]	FIXED ROUTE 40'
[Light Blue Box]	FIXED ROUTE 60'
[Orange Box]	PARATRANSIT 25'
[Dark Blue Box]	VEHICLE MAINTENANCE
[Light Blue Box]	OPERATIONS (GROUND)
[Light Blue Box]	OPERATIONS (ABOVE)
[Yellow Box]	FUEL & WASH
[Yellow Box]	FACILITY MAINTENANCE

DRAWING NUMBER <b>1(E)C</b>	DRAWING TITLE <b>OPTION 1(E)C NEW FACILITIES EAST W/ OPS ABOVE MAINT</b>	 <small>PARSONS BRINCKERHOFF 1000 PINE HILL SUITE 500 HOUSTON, TEXAS 77004 TEL: (281) 596-0000 FAX: (281) 700-0184</small>	PROJECT TITLE <b>ABQ RIDE YALE MAINTENANCE FACILITY ASSESSMENT</b>	PROJECT NO. 33722A DRAWN BY: MM DATE: 4/17/2015 SCALE: 22x4 1/32" 11 x 17 1/64"
--------------------------------	---	---	---	---

# EXECUTIVE SUMMARY

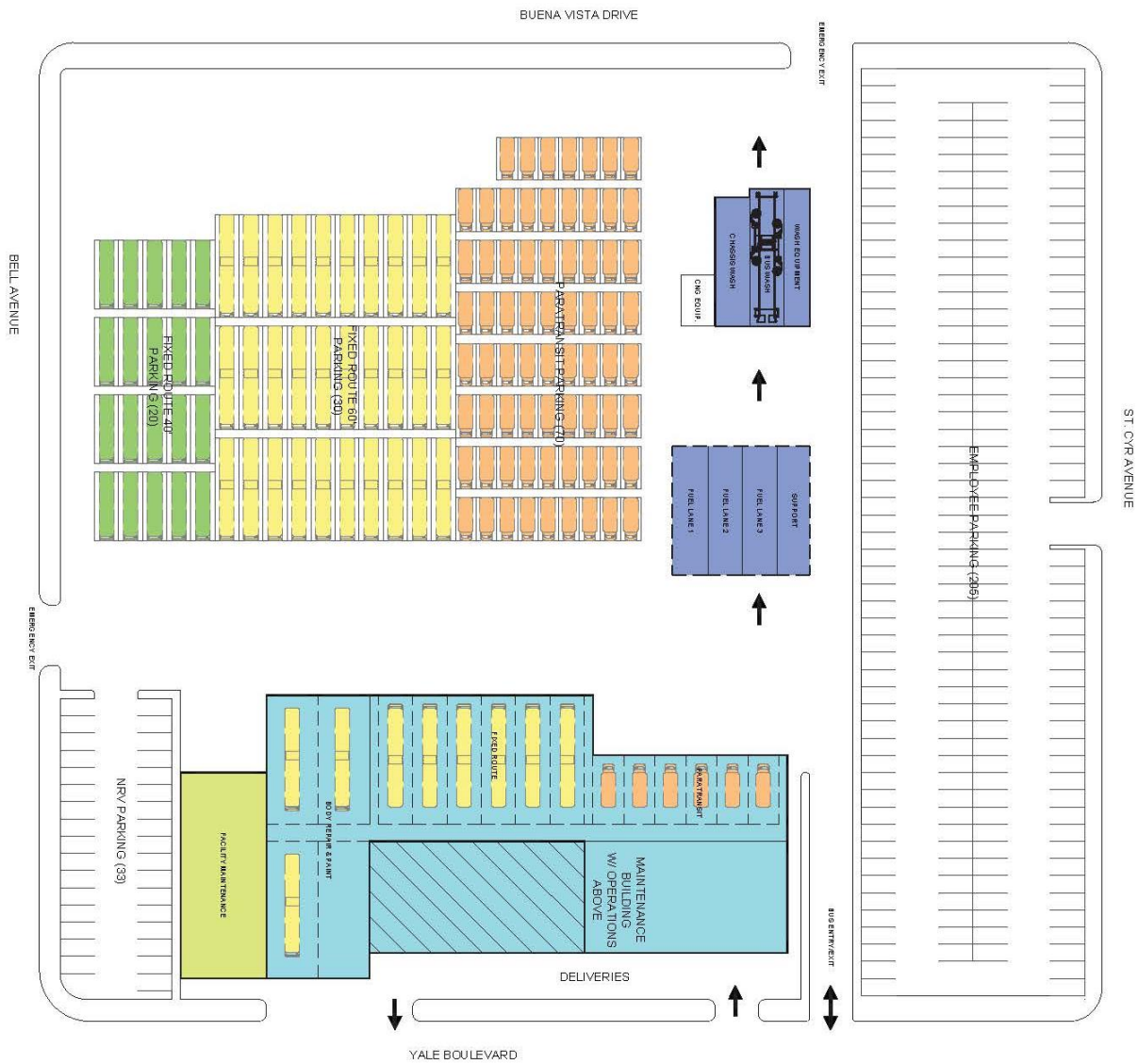

DESIGN FLEET	
20	FIXED ROUTE 40'
30	FIXED ROUTE 60'
70	PARATRANSIT 25'
120	TOTAL
20	NRV

  

LEGEND	
[Green Box]	FIXED ROUTE 40'
[Yellow Box]	FIXED ROUTE 60'
[Light Blue Box]	PARATRANSIT 25'
[Dark Blue Box]	VEHICLE MAINTENANCE
[Red Box]	OPERATIONS (GROUND)
[Blue Box]	OPERATIONS (ABOVE)
[Light Blue Box]	FUEL & WASH
[Green Box]	FACILITY MAINTENANCE

DRAWING NUMBER <b>2(E)C</b>	DRAWING TITLE <b>OPTION 2(E)C NEW FACILITIES EAST W/ OPS ABOVE MAINT</b>	 <small>1600 PARK HWY SUITE 300 HOUSTON, TEXAS 77056 TEL: (817) 420-2600 FAX: (817) 700-0100</small>	PROJECT TITLE <b>ABQ RIDE YALE MAINTENANCE FACILITY ASSESSMENT</b>	PROJECT NO. 33722A DRAWN BY: MM DATE: 4/17/2015 SCALE: 22x34 1/32" 11 x 17 1/84"
--------------------------------	---	---	---	--



# EXECUTIVE SUMMARY

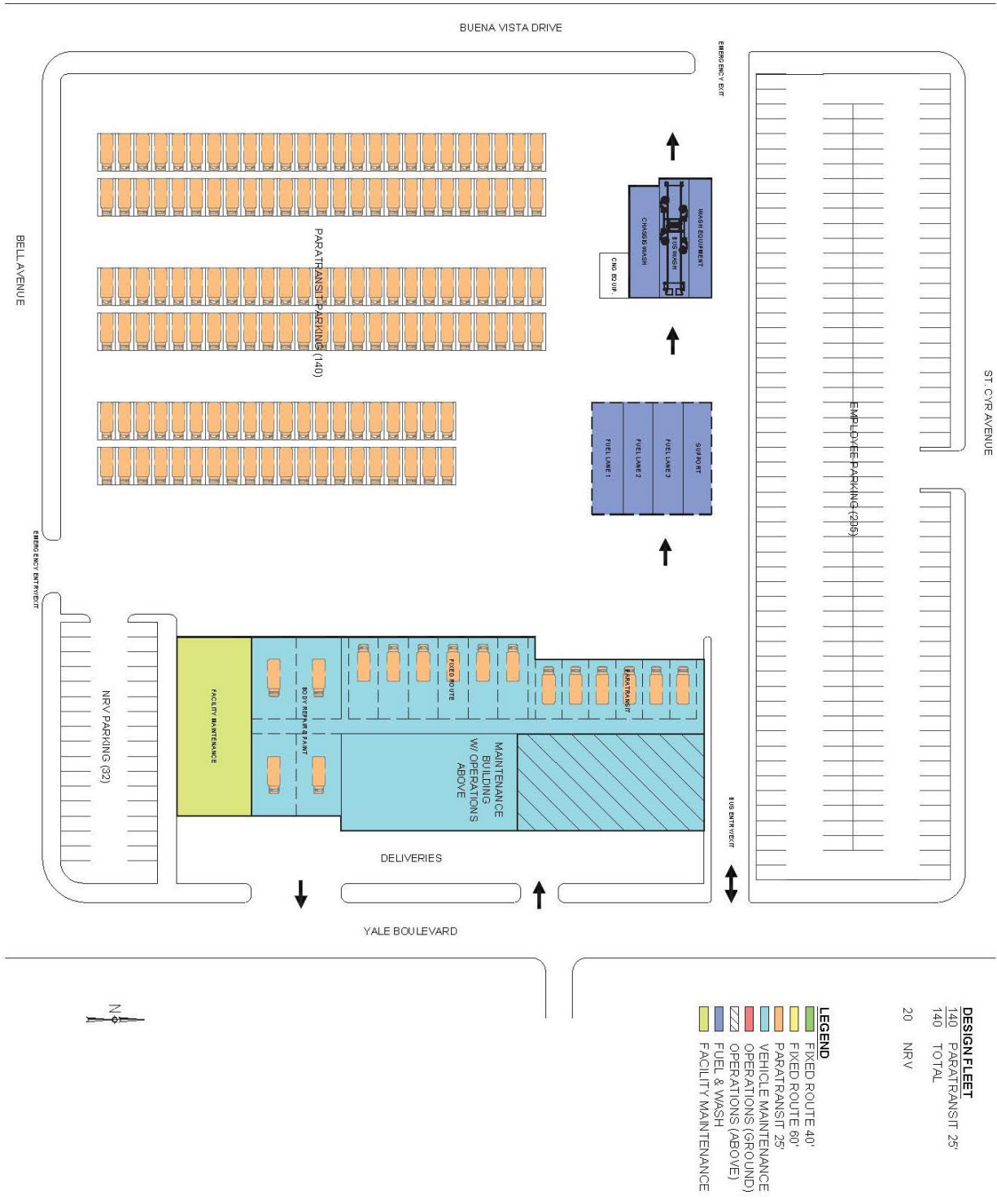

DRAWING NUMBER <b>3(E)C</b>	DRAWING TITLE <b>OPTION 3(E)C NEW FACILITIES EAST W/ OPS ABOVE MAINT</b>	<b>PARSONS BRINCKERHOFF</b> <small>4800 PARK DRIVE SUITE 100 ALBUQUERQUE, NEW MEXICO 87106 TEL: (505) 266-9900 FAX: (505) 789-0100</small>	PROJECT TITLE <b>ABQ RIDE YALE MAINTENANCE FACILITY ASSESSMENT</b>	PROJECT NO. 33722A DRAWN BY MM DATE 4/17/2015 SCALE 22x34 1/32" 11 x 17 1/8"
--------------------------------	---	---	---	--

# EXECUTIVE SUMMARY

The charts below show the analysis of the three main options (blue) and the options for Operations (red).

	OPTION 1: 40' BUS & PARATRANSIT	OPTION 2: 60' BUS, 40' BUS, & PARATRANSIT	OPTION 3: PARATRANSIT ONLY
ADVANTAGES	<ol style="list-style-type: none"> <li>1. Provides flexibility to serve multiple vehicle types (40' bus and paratransit).</li> <li>2. Simpler site configurations for new layouts due to smaller maintenance facility footprint.</li> <li>3. Reduced costs compared to options serving 60' buses via smaller facility footprint.</li> <li>4. Reduced costs compared to options serving 60' buses via lower cost lifts and paint booths for 40' vehicles.</li> <li>5. Paratransit may reduce deadhead from shorter run distances if operated from Yale. <i>(ABQ Ride to verify)</i></li> </ol>	<ol style="list-style-type: none"> <li>1. Maximum future-proofing and flexibility due to ability to serve all vehicle types in ABQ Ride fleet.</li> <li>2. Paratransit may reduce deadhead from shorter run distances if operated from Yale. (Info to be supplied by ABQ Ride Operations - vehicle deadhead is not part of this study)</li> <li>2. 60' BRT vehicles may reduce deadhead from shorter run distances if operated from Yale. <i>(ABQ Ride to verify)</i></li> </ol>	<ol style="list-style-type: none"> <li>1. Creates a specialized facility to focus on paratransit vehicles and segregate specialty tools and parts associated with paratransit operations and maintenance.</li> <li>2. Simpler site configurations for new layouts due to smaller maintenance facility footprint, however, the footprint could be further reduced by reducing length of longer bays that provide flexibility to maintain 40' buses.</li> <li>3. Reduced costs compared to options serving 60' buses via smaller facility footprint.</li> </ol>
DISADVANTAGES	<ol style="list-style-type: none"> <li>1. Reduced flexibility due to inability to service 60' buses.</li> <li>2. Paratransit may incur higher deadhead from increased run distances if operated from Yale. <i>(ABQ Ride to verify)</i></li> </ol>	<ol style="list-style-type: none"> <li>1. More difficult for site configuration and circulation due to larger maintenance facility footprint.</li> <li>2. Increased costs due to larger facility footprint to accommodate 60' buses.</li> <li>3. Increased costs due to lifts and paint booth required to service 60' buses.</li> <li>4. 60' BRT vehicles may incur higher deadhead from increased run distances if operated from Yale. <i>(ABQ Ride to verify)</i></li> </ol>	<ol style="list-style-type: none"> <li>1. Reduced flexibility due to inability to service 60' buses.</li> <li>2. Reduced flexibility due to inability to lift 40' buses without additional lift purchases and changes to bay layouts. (Lube reels, exhaust, etc.)</li> <li>3. Paratransit may incur higher deadhead from increased run distances if operated solely from Yale. <i>(ABQ Ride to verify)</i></li> </ol>

	SUB-OPTION A: REUSE EXISTING OPERATIONS	SUB-OPTION B: NEW STAND-ALONE OPERATIONS BUILDING	SUB-OPTION C: NEW OPERATIONS ABOVE MAINTENANCE
ADVANTAGES	<ol style="list-style-type: none"> <li>1. Reduced costs from reusing the existing operations facility.</li> <li>2. Less interruption to operations due to reuse of existing operations facility.</li> </ol>	<ol style="list-style-type: none"> <li>1. Increased site space and employee parking due to reduced building footprint.</li> <li>2. Operational efficiency gains from properly designed and sized spaces for transit operations.</li> <li>3. Cost savings over time from improved / sustainable building systems with lower operational costs over the facility's lifetime.</li> <li>4. Improves site circulation for transit vehicle traffic due to better building location and proper footprint.</li> </ol>	<ol style="list-style-type: none"> <li>1. Maximizes site space and employee parking due to reduced ground level footprint.</li> <li>2. Operational efficiency gains from properly designed and sized spaces for transit operations.</li> <li>3. Cost savings over time from improved / sustainable building systems with lower operational costs over the facility's lifetime.</li> <li>4. Improves site circulation for transit vehicle traffic due to removing operations building from ground level footprint.</li> <li>5. Reduced construction costs due to shared systems (shared walls, HVAC, etc.)</li> </ol>
DISADVANTAGES	<ol style="list-style-type: none"> <li>1. Reduces flexibility and efficiency for transit vehicle site circulation due to oversized footprint and non-ideal location of existing Operations Building.</li> <li>2. Operations continues to occupy an oversized space.</li> <li>3. Higher operational costs due to old construction and non-sustainable building systems for the entire lifetime of the facility.</li> </ol>	<ol style="list-style-type: none"> <li>1. Higher costs than reusing existing facilities.</li> <li>2. Loss of site space for employee parking due to new building footprint.</li> <li>3. Higher construction costs due to required systems for stand-alone building (Exterior walls, HVAC, etc.)</li> </ol>	<ol style="list-style-type: none"> <li>1. Higher costs than reusing existing facilities.</li> </ol>



---

**EXISTING SITE & FACILITY REVIEW**



# EXISTING SITE AND FACILITY REVIEW

---

## Background

ABQ RIDE provides transit service to the Albuquerque metropolitan area with 21 regular fixed routes, 15 commuter routes, 3 Rapid Ride routes, and one downtown circulator. This service is operated out of two facilities, the older Yale Facility and the newer Daytona Facility. The current fleet of 160 transit buses is allocated between the two facilities with all articulated vehicles operating from Daytona and all CNG vehicles operating from Yale. (See Fleet Projections in Appendix D.)

In addition, the Daytona Facility houses the paratransit fleet. Note that CNG fueling is only available at the Yale Facility. A fleet of 21 new forty foot CNG buses was recently delivered to replace some of the older forty foot CNG buses in the fleet.

As part of the Yale Maintenance Facility Assessment project, the study team was tasked with evaluating the condition of the existing Yale Maintenance Facility. The facilities included in the study are the following facilities at the Yale site:

- Vehicle Maintenance
- Fuel and Wash
- Old Garage
- New Garage
- SunVan Facility

While the existing Transportation Building was not part of the study, a quick evaluation of the facility is included herein.

See Figure 1 on the next page for an aerial site plan of the Yale Facility showing the facilities evaluated.

In addition, the current on-site traffic flow is shown in Figure 2.

The study team visited the facilities during the week of February 2, 2015 and followed-up with additional visits during the week of April 6, 2015 to visually observe the facilities and current operations. This section documents these observations and provides photos to illustrate some of those conditions. Following the observations are ideas to be considered to address deficiencies noted. These ideas are shown in ***bold italic type face***.

The site visits, facility observations, and discussions with ABQ staff became the basis for the design criteria presented in chapter 2 and the conceptual plans presented in chapter 3 of this report.

The study team also visited the Daytona Facility to understand the existing capabilities available in the ABQ Ride system and how any changes and opportunities at the Yale Facility would affect ABQ Ride's overall operations. An analysis of the overall capacity of the Yale and Daytona facilities is shown in Appendix E.

# EXISTING SITE AND FACILITY REVIEW

Figure 1: Aerial Site Plan of Existing Yale Facility



# EXISTING SITE AND FACILITY REVIEW

Figure 2: Existing Transit Vehicle Traffic Flow

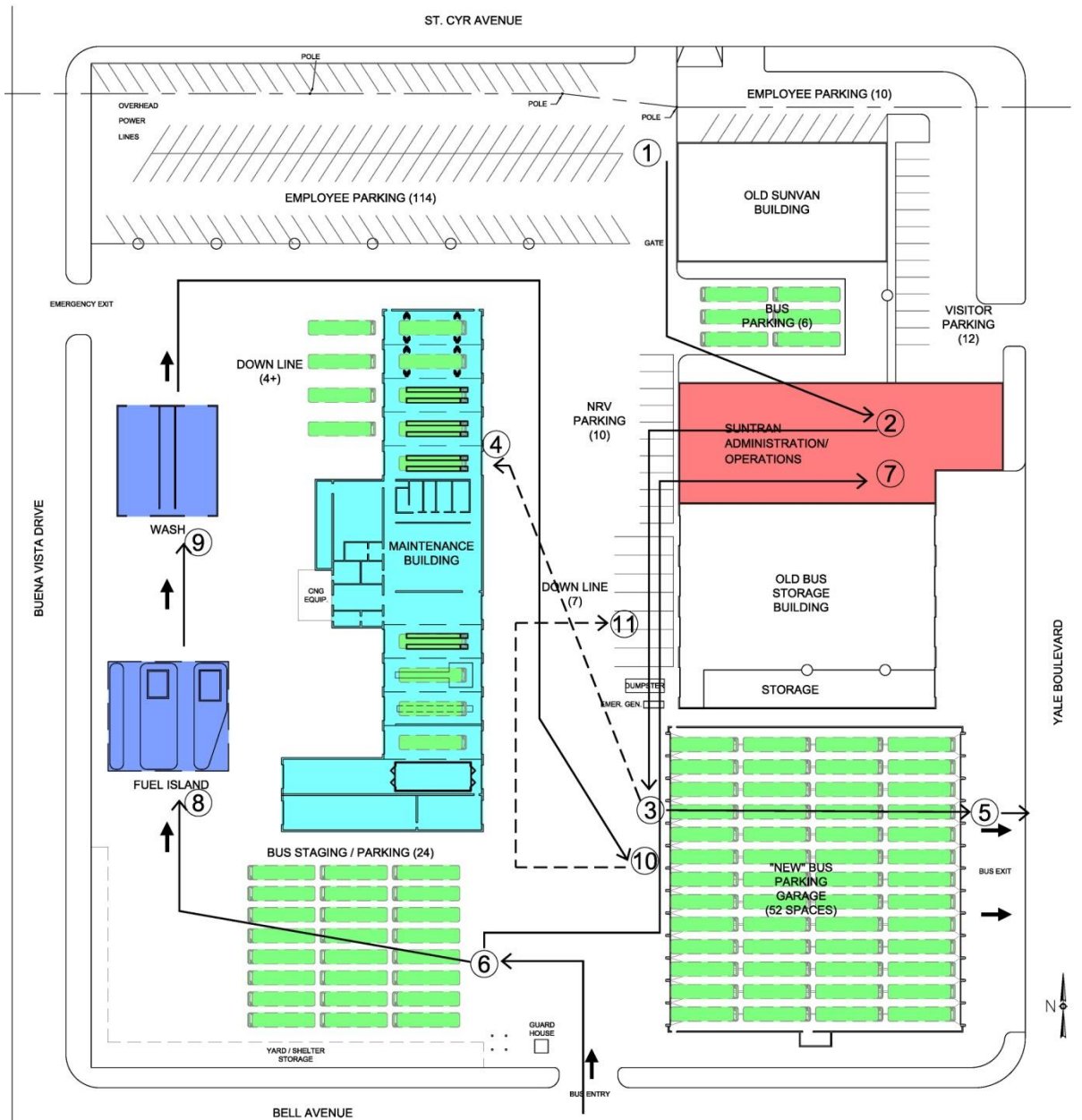

## Existing Transit Vehicle Traffic Flow

1. Driver arrives on site and parks in employee parking area.
2. Driver picks up route information and bus assignment at the Operations Center.
3. Driver performs a pre-trip inspection in the Agency Vehicle Parking area to check lights, brakes, tires, and cleanliness. The bike rack is cycled in the bus parking spot. After a bus leaves its parking spot it drives to a separate area and cycles its wheelchair lift prior to leaving the site.
4. If a problem is found with the bus, it is taken to maintenance for immediate repairs.

## **EXISTING SITE AND FACILITY REVIEW**

---

5. Bus leaves site and goes on route.
6. Buses returning to the site are parked in the Bus Staging Area to wait for nightly servicing.
7. Driver reports in to the Operations Center and typically leaves the site.
8. Service worker picks up bus from the Bus Staging Area, sweeps out and cleans the interior in the yard, and drives to the Fuel / Wash area to fuel the vehicle and top off fluids. Fares are retrieved by the Vault Pull Specialist.
9. Bus is taken through the Wash area for exterior cleaning.
10. If no problems are reported, bus is returned to assigned area in Bus Parking.
11. If a problem is reported or service is scheduled, bus is parked in Down Line for maintenance.
12. After maintenance, bus is returned to Bus Parking area.



# EXISTING SITE AND FACILITY REVIEW

## Employee / Visitor Parking (corner of Yale Boulevard and St. Cyr Avenue)

- Existing Employee parking area is small (22 spaces) and not secure.
- Extensive pavement cracking throughout (Photo 1).

***Employee parking should be secure.***

***Pavement in employee parking should be free of cracks and potholes.***

**Photo 1**



## Employee Parking (north end of site)

- Manual gate at entrance is not used, leaving the parking area unsecured (Photo 2).
- Power poles are located inside the site approximately 20 feet from the property line. This eliminates two parking spaces (Photo 3).
- There is no gate separating Employee Parking from main site and transit vehicle circulation (Photo 4).
- Extensive pavement cracking throughout (Photo 5).

**Photo 2**



***Employee vehicle traffic should be separated from bus traffic for safety.***

**Photo 3**



**Photo 4**



**Photo 5**



# EXISTING SITE AND FACILITY REVIEW

---

## Exterior Bus Parking and Circulation

- Buses currently circulate clockwise on the site.
- Pavement in bus circulation is badly cracked asphalt (Photos 6, 7, and 8).

***Bus circulation should ideally be counter-clockwise to improve safety and reduce body damage.***

***Pavement in bus circulation areas should be concrete and should be free of cracks and potholes.***



***Photo 6***



***Photo 7***



***Photo 8***

# EXISTING SITE AND FACILITY REVIEW

---

## Security

- A security fence surrounds the site.
- Gates in the fence are typically left open.
- A security guard house is located at the bus entrance on Bell Avenue (Photo 9).
- The guard house is in a state-of-disrepair (Photo 10).
- There is no CCTV surveillance of the site.

***The entire site should be fenced to secure the bus parking area and bus operations.***

***CCTV cameras should be strategically placed on the site to record activity on the site.***

***The guard house should be upgraded (if a security guard will be provided).***



***Photo 9***



***Photo 10***

# EXISTING SITE AND FACILITY REVIEW

---

## Yard

- Asphalt throughout the yard is in extremely poor condition (Photos 11 and 12).
- Materials and components are stored outdoors along the perimeter of the site (Photos 13 and 14).
- A fire hydrant is located at the southwest corner of Maintenance Building (Photo 15) and near the CNG compressor equipment (Photo 16).

***All bus circulation areas should be concrete pavement that is free of cracks and pot holes.***

***Inventory items should be stored in the secure parts storeroom.***

***Shelter components, benches, etc. should be stored in a secure area separated from bus traffic for better safety and security.***

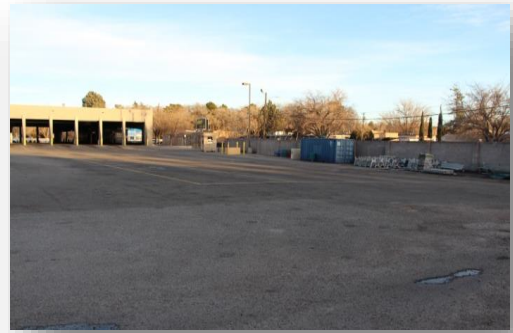

**Photo 11**



**Photo 12**



**Photo 13**



**Photo 14**



**Photo 15**



**Photo 16**

# EXISTING SITE AND FACILITY REVIEW

## MAINTENANCE BUILDING

**Figure 3: Existing Maintenance Building**

*Note that none of the repair bays will accommodate an articulated (60 foot) bus.*

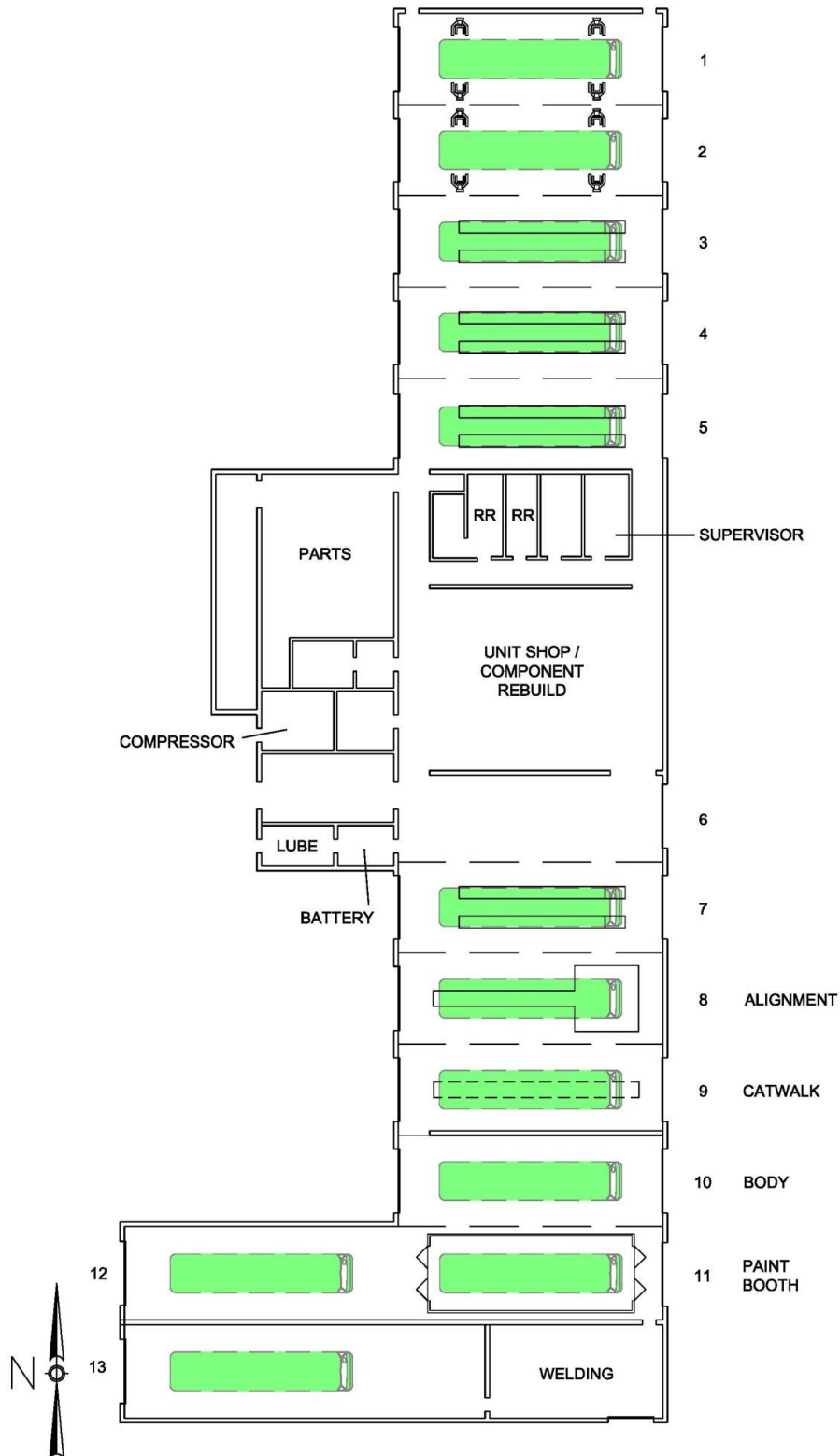

# EXISTING SITE AND FACILITY REVIEW

---

## Exterior

- The gas main is located on northeast corner of Maintenance Building (Photo 17).
- All overhead doors are metal coiling type doors with no vision panels (Photo 17).
- Portable equipment is stored outdoors on the north end of the Maintenance Building (Photo 18) because there is no room for this function in the repair bays.
- The Maintenance Building is a pre-engineered steel structure with metal panel exterior walls and standing seam metal roof.



**Photo 17**

***Consideration should be given to utilizing insulated overhead doors with vision panels to provide natural light into the repair bays and for safety.***

***Adequate indoor space should be provided near the repair bays for storing portable equipment. This will improve efficiency and extend the life of the equipment.***

***Consideration should be given to utilizing a hard surface for maintenance facility walls (masonry, concrete, etc.) at least to the height of the top of the overhead doors, that will withstand the industrial environment and be easily cleaned.***



**Photo 18**

# EXISTING SITE AND FACILITY REVIEW

## Bays 1 through 5 (North Bays)

- Lighting is inadequate throughout the bays (Photo 19).

### **High bay fluorescent or LED lighting should be considered**

- Vehicle exhaust is handled via ceiling mounted hoses (Photo 20).
  - The exhaust hose is not capable of handling vehicle exhaust temperatures during the regen process.

### **Overhead vehicle exhaust reels should be provided with the first 10 feet of the hose being designed to withstand high temperatures.**

- Floor drainage facility appears inadequate.
- In-floor waste oil collection drains are located at the rear of bays.
- Existing in-ground lifts have been abandoned but not removed.
- Surface mounted parallelogram vehicle lifts have been installed, in some cases directly over the abandoned in-ground lifts (Photo 21).
- CNG sensors with ventilation shutters are located at the ceiling.
- CNG gas relief / evacuation hoses are located in each bay.
- Support for lubrication reels is from overhead beams.
- Mechanic tool boxes must be stored between the repair bays because there is not designated space for them (Photo 22).
- Portable equipment is currently stored between repair bays which impedes circulation (Photo 22).

### **Adequate, designated space should be provided for mechanic tool boxes and portable equipment.**



Photo 19

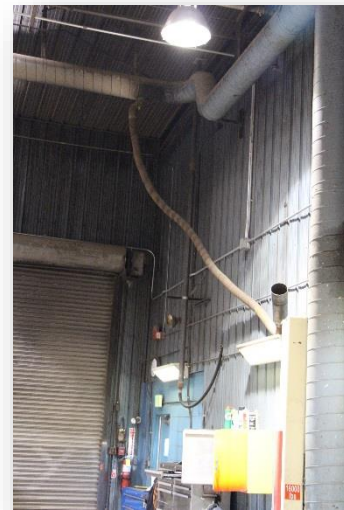

Photo 20

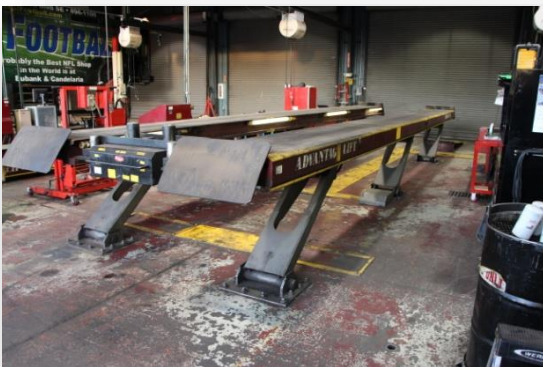

Photo 21



Photo 22

# EXISTING SITE AND FACILITY REVIEW

## Unit Shop / Component Rebuild

- Lighting is inadequate (Photo 23).
- Circulation paths are not clearly designated (Photo 24).
- An underhung 3-ton bridge crane covers the shop (Photo 25).
- High voltage electrical panels are located on both sides of the shop.
  - Items are stored in the clearance areas for the high voltage panels (Photos 26 and 27).
- Radiant heat has been installed too close the crane and must be shielded (Photo 25).
- Brakes are turned on the brake lathe adjacent to where transmissions are rebuilt. The dust from the lathe operation is not compatible with component rebuild (Photo 24).

***High bay fluorescent or LED lighting should be considered.***

***Clearance must be maintained around all electrical panels, per code requirements.***

***Consideration should be given to doing all component rebuild at the Daytona Facility, which is much better equipped and has adequate space.***

***The brake lathe should be located so that surrounding spaces are not impacted by dust.***



**Photo 23**



**Photo 24**

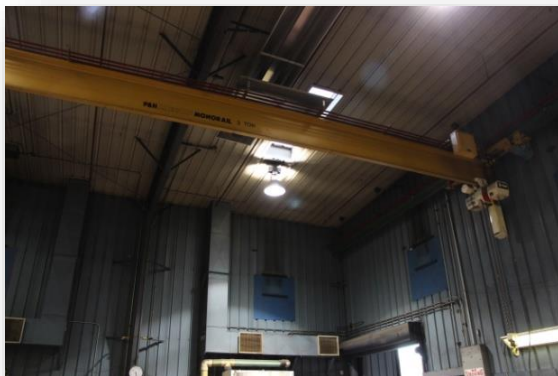

**Photo 25**



**Photo 26**



**Photo 27**



# EXISTING SITE AND FACILITY REVIEW

## Restrooms / Locker Rooms

- Water fountain does not meet ADA.
- Showers and sinks do not meet ADA.
- Toilets do not meet ADA.
- Locker room clearances do not meet ADA (Photo 28).
- The line of sight from the corridor into the restrooms is poor.
- Showers are used for storage (Photos 29 and 30).
- Semi-circular stainless steel hand wash sinks are provided (Photo 31). These typically do not provide water streams that are adequate for easy cleaning.

***All restroom facilities need to be upgraded to meet ADA requirements.***

***Consideration should be given to using stainless steel trough type sinks with gooseneck faucets with paddle controls.***

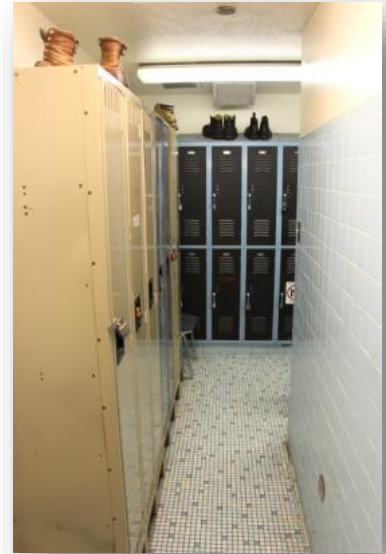

***Photo 28***



***Photo 29***



***Photo 30***



***Photo 31***

# EXISTING SITE AND FACILITY REVIEW

---

## Supervisor Office

- Parts cabinets with nut and bolt storage located in office because there is no room on the shop floor (Photo 32).
- Fire alarm panels and gas protection alarm panels (Photo 33) are mounted on the office wall.
- The view to shop floor has been blocked out (Photo 34).



*Photo 32*



*Photo 34*



*Photo 33*



*Photo 33A*



*Photo 33B*

# EXISTING SITE AND FACILITY REVIEW

## Parts Storeroom

- The Parts Storeroom is too small to hold all inventory items. Components are stored in the yard and in the Old Garage.
- The parts issue window is small and not conveniently located to the repair bays (Photo 35).
- A combination of shelving and drawer units are used (Photo 36 and 37).
- Space for shipping and receiving is not adequate.
- Trucks making deliveries transverse bus circulation and can block bus traffic.
- There is no forklift access to or within the Parts Storeroom (Photo 38).
- Access to the mezzanine parts storage area is via stair or monorail (Photos 39 and 40).
- The mechanics break area is on the mezzanine (near the parts storage) and does not meet ADA requirements (Photo 41).



**Photo 35**



**Photo 36**



**Photo 37**

***Ideally, all inventory should be kept in one secure parts storeroom with forklift access and adequate circulation space.***

***Consideration should be given to keeping the entire Parts Storeroom on the ground level for better safety.***

***The type and quantity of storage systems should be carefully evaluated to provide efficient use of space and improve retrieval time.***

# EXISTING SITE AND FACILITY REVIEW

---



*Photo 38*



*Photo 39*

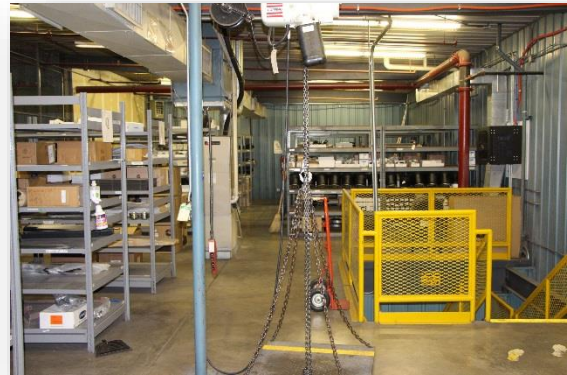

*Photo 40*



*Photo 41*

# EXISTING SITE AND FACILITY REVIEW

## Battery Room

(Photo 42)

- The circulation aisle in the battery room is narrow.
- Light fixtures are not explosion proof.
- The height of the battery table requires batteries to be lifted quite high.

***Consideration should be given to moving the battery function from an interior room (i.e. not on an outside wall) to a pre-engineered haz mat building that is designed for the function and is located convenient to the repair bays.***



Photo 42

## Lube / Compressor Room

- Lubricants are stored in 55-gallon drums with no secondary spill containment (Photo 43).
- Air compressors are in a separate room and are not connected to a refrigerated air dryer (Photo 44).
- Note that there is a separate compressor for the tire shop in the shop area. ***The main compressors should be sized to eliminate the need for a separate compressor for the tire shop.***
- Thin metal walls do not provide adequate acoustic separation from surrounding spaces.

***Consideration should be given to locating the lube tanks and pumps in the same room with the air compressors. This will contain the noise in one room and allow for easier acoustical separation.***

***Double wall tanks should be utilized for lubricants that are used in larger quantities such as engine oil, ATF, and coolant.***

***Secondary spill containment should be provided under any drums.***



Photo 43



Photo 44

# EXISTING SITE AND FACILITY REVIEW

---

## Tire Shop / Storage

- The Tire Shop is in the Tire Bay (Bay 6) and does not have adequate space for tire changing equipment and for tire storage (Photo 45).
- A separate air compressor is provided on the shop floor for the Tire Shop (Photo 46), which is very loud when it is running.

***Consideration should be given to locating Tire Shop / Storage in a separate room adjacent to the Tire Bay. This would allow for acoustic separation and for greater security.***

***The main compressor in the Lube / Compressor Room should be sized to accommodate the Tire Shop so that a separate compressor is not required. This will also help reduce noise in the shop.***



Photo 45



Photo 46

## Tire Bay (Bay 6)

- There is no vehicle lift in the Tire Bay (Photo 47).
- Lighting is centered on the bay (i.e. on top of a bus when it is in the bay).

***Consideration should be given to providing an in-ground adjustable post lift in the Tire Bay.***

***The Tire Bay should be located adjacent to other repair bays so that it can be used for other maintenance activities when not being used for tire work.***

***Lighting should be along the sides of the bay to illuminate the work area where tire work is done.***

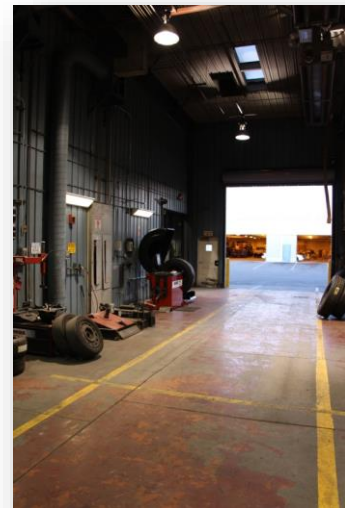

Photo 47

# EXISTING SITE AND FACILITY REVIEW

---

## Bay 7

- The original in-ground lift has been abandoned, but still remains under the newer parallelogram lift (Photo 48).
- Observations and recommendations made under Bays 1 through 5 (North Bays) regarding lighting, vehicle exhaust, floor drainage, waste oil collection CNG, lubrication reels, and space for mechanic tool boxes and portable equipment apply to Bay 7.



*Photo 48*

## Alignment Bay (Bay 8)

- The alignment pit eliminates the possibility for making Bay 8 a drive-thru bay.
- The length of the bay does not allow for a 40-foot transit bus to be maintained in the bay without extending over the open pit area.
- Observations and recommendations made under Bays 1 through 5 (North Bays) regarding lighting, vehicle exhaust, floor drainage, waste oil collection CNG, lubrication reels, and space for mechanic tool boxes and portable equipment apply to Alignment Bay (Bay 8).



*Photo 49*

***Consider locating an alignment pit at the end of a bay that is sized to accommodate a transit bus without having to extend over the pit.***

# EXISTING SITE AND FACILITY REVIEW

---

## Catwalk Bay (Bay 9)

- Jib crane has limited coverage and reach (Photo 50).
- The bay has a pit and a catwalk for access to roof mounted equipment on a bus.
- The pit (Photos 51 and 52) has:
  - Poor lighting.
  - No pit protection.
  - Poor drainage.
  - No air or lube reels.
  - A fixed depth that is too deep.
- The catwalk (Photo 53) has:
  - No fall protection.
  - A gap between the catwalk and the edge of the bus roof, which requires mechanics to step over the gap and is not safe.



**Photo 50**



**Photo 51**



**Photo 52**

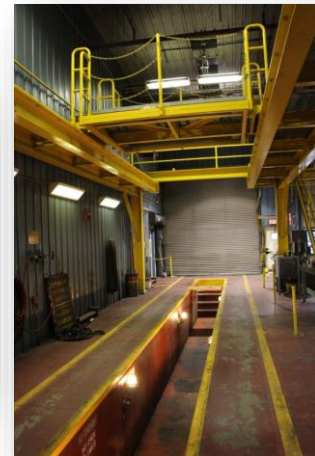

**Photo 53**

***Consideration should be given to eliminating the catwalk and replacing it with an overhead fall protection system and suspended bridge crane.***



# EXISTING SITE AND FACILITY REVIEW

## Body Repair Bay (Bay 10)

- Light fixtures and radiant heat placement are located directly over a vehicle in the bay (Photo 54).
- The bay is not wide enough to efficiently work on the side of a bus.
- Piping for a central vacuum system has been abandoned.

***Most of the work on a bus in a body repair bay is on the side of the bus and the bay has a wall on one side and the paint booth along the other side. For these reasons, a body repair bay is typically at least 30 feet wide.***

***Light fixtures and radiant heaters should be located along the sides of the bay to properly serve the work area below.***

***Consider replacing the central vacuum system.***

***An overhead reel vehicle exhaust system should also be provided in this bay.***



***Photo 54***



***Photo 55***

# EXISTING SITE AND FACILITY REVIEW

## Paint Booth (Bay 11)

The paint booth (Photo 56):

- Is a cross draft type booth.
- Is barely long enough to accommodate a 40 foot transit bus.
- Does not have a man lift on either side of the booth for accessing the upper portion of a bus.
- Has abandoned vacuum system piping.

***Consideration should be given to providing a down-draft booth sized to accommodate every bus in the ABQ fleet, including articulated (60 foot) buses.***

***A three-axis man lift should be provided on each side of the booth.***

***Vacuum system piping should be removed.***



Photo 56

## Paint Prep Bay (Bay 12)

- Light fixtures and radiant heat placement are located directly over a vehicle in the bay (Photo 57).
- The bay is not wide enough to efficiently work on the side of a bus (Photo 58).
- High pressure sodium lighting is inadequate.

***Most of the work on a bus in a body repair bay is on the side of the bus and the bay has a wall on one side and the paint booth along the other side. For these reasons, a body repair bay is typically at least 30 feet wide.***

***Light fixtures and radiant heaters should be located along the sides of the bay to properly serve the work area below.***

***Consider replacing the central vacuum system.***

***An overhead reel vehicle exhaust system should also be provided in this bay.***



Photo 57



Photo 58

# EXISTING SITE AND FACILITY REVIEW

## Welding Bay (Bay 13)

- Light fixtures and radiant heat placement are located directly over a vehicle in the bay (Photo 59).
- High pressure sodium lighting is inadequate.
- Abandoned lift remains in floor and the lift power unit is above ground in the bay (Photo 60).
  - Need to confirm lift has been properly decommissioned.
- The air compressor is not isolated from work area (Photo 61).
- Inventory is stored in the open and not in a controlled area.
- Bay location is isolated and difficult to access and supervise.
- Miscellaneous storage on the floor makes the space less usable for maintenance (Photo 62).

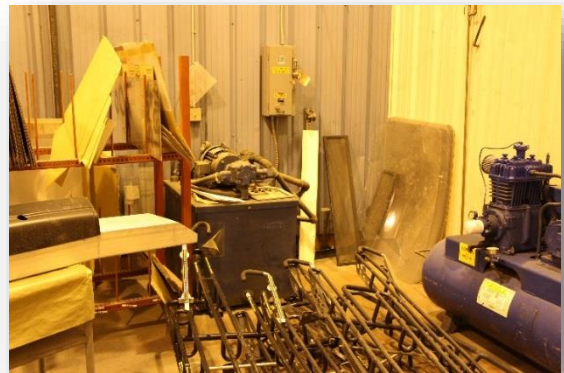

**Photo 59**

***Lighting should be full spectrum lighting such as high bay fluorescent or LED.***

***Central air compressor should be sized to eliminate the need for a remote compressor.***

***Ideally, all inventory should be kept in one secure parts storeroom***



**Photo 60**

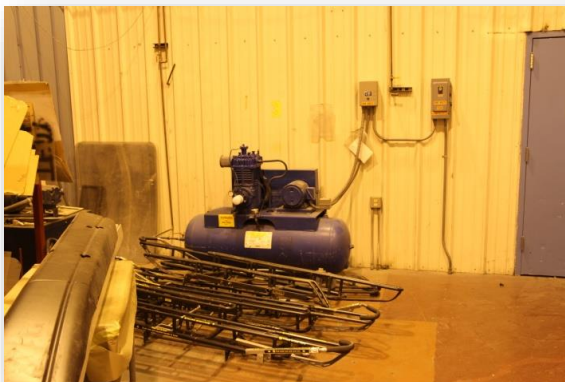

**Photo 61**



**Photo 62**

# EXISTING SITE AND FACILITY REVIEW

---

## Welding Shop

(Photos 63, 64, and 65)

The Welding Shop is:

- Poorly lit.
- Has no access to the welding bay.
- Has poor access to the rest of the facility.
- Does not have adequate ventilation.
- Has no overhead crane or lifting ability.

***If a welding shop is needed, it should be easily accessible to the body shop and body repair bays.***

***Adequate ventilation must be provided per code requirements.***

***Consideration should be given to providing a suspended overhead crane.***



**Photo 63**



**Photo 64**

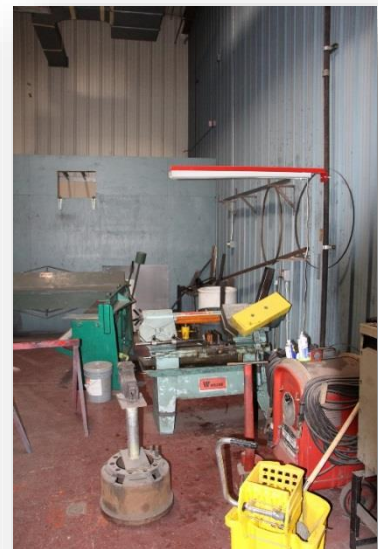

**Photo 65**

# EXISTING SITE AND FACILITY REVIEW

## FUEL ISLAND

The Fuel Facility includes three fueling positions. The following are observations made at the fuel island:

- Fuel lanes are poorly drained and standing water creates a safety hazard (Photo 66). Curbs also create a tripping hazard during the nightly servicing cycle.
- Speed bumps are located at the lane entrances to keep water out.
- The underground tank farm is located under the entrance to the fuel lanes (Photo 67). Fuel delivery trucks block the lanes and when any work is required on the tanks, access to the fuel lanes is blocked.
- A through the wall vault drop (Photo 68) is located in the middle lane, but on the wrong side. This requires the vault puller to cross in front of a bus, which creates a safety hazard.
- The (orange) vault drop for the west lane (Photo 68) is not conveniently located, which can negatively impact productivity.
- Overhead reels are not retracting, so hose is on the ground (Photo 66) creating a tripping hazard.
- There is no fuel hose management system.
- Vehicle interior sweeping and mopping takes place in the yard in front of Fuel Island.
  - No receptacles for trash are provided, so trash is swept directly into the yard.
- The fuel and wash facilities are located on the site in such a way that requires buses to circle the maintenance building throughout the nightly service cycle in a clockwise traffic flow



Photo 66



Photo 67



Photo 68

**Consideration should be given to replacing the fuel (and wash) facilities to:**

- **Allow adequate space for fueling and interior clean (so that buses do not have to be swept in the yard).**
- **Eliminate curbs in the islands.**
- **Provide a gantry for fuel hose management.**
- **Provide new lube reels.**
- **Properly locate fuel tanks so that accessing the tanks will not block the fuel lanes.**
- **Conveniently locate vault drops to improve safety.**
- **Provide proper drainage.**
- **Provide proper lighting.**

# EXISTING SITE AND FACILITY REVIEW

---

## CNG Compressor Equipment

- The two existing CNG compressors are located on the west side of the Maintenance Building (Photo 69) and were scheduled to be replaced in-place.
- The location of the existing compressors creates a crowded bus circulation lane that is also shared with delivery trucks at the parts storeroom (Photo 70).
- CNG storage tanks are located between the fuel lanes (Photo 71).
- The Yale Facility is the only facility that currently has CNG fueling capability.

***Consideration should be given to keeping the existing CNG compressors at Yale for back-up and building a new CNG compressor and fueling capability at the Daytona Facility. This will give ABQ Ride more flexibility and back-up fueling capability.***

***The Daytona Facility also has significantly more space to accommodate new CNG compressors.***



***Photo 69***



***Photo 70***



***Photo 71***

# EXISTING SITE AND FACILITY REVIEW

---

## WASH BUILDING

- The Wash Building includes a bus washer lane, a chassis wash bay, and a water reclamation system.
- The wash lane and chassis wash bay are in a drive through configuration.
- The facility is a pre-engineered metal building.

## Exterior

- The metal siding extends to a curb at ground level and is exposed to bus traffic. The siding has been damaged (Photo 72) and needs to be replaced.
- Drainage on the north side of the building (at the exit end where a blower is located at the end of the wash) has no catch basin. Water drains from the wash lanes and into the site. (Photo 73)
- The Wash Building is too short to properly accommodate modern vehicle wash equipment. Note that the blowers are located outside, which reduces the life expectancy of this equipment.
- Various materials and components (surplus, abandoned items, and inventory items) are stored along the west side of the Wash Building.



*Photo 72*



*Photo 73*

***The Wash Building should be replaced with a facility that:***

- ***Is at least 80 feet long to accommodate modern wash equipment.***
- ***Is constructed of masonry or concrete to resist wear and tear and a wet environment.***
- ***Is properly placed in relation to the fuel facility.***
- ***Has proper drainage both inside the building and outside in the vehicle circulation area.***

# EXISTING SITE AND FACILITY REVIEW

---

## Wash and Water Reclaim

- Lighting is poor in the wash bay with limited nighttime visibility (Photo 74).
- Drainage grates are covered with steel plates in some areas.
- The water reclamation system is inoperable and has been bypassed.
- Radiant heating is used in the bays along with exhaust ductwork that is rusting (Photo 75).



**Photo 74**



**Photo 75**

*See recommendations/considerations on the previous page.*



# EXISTING SITE AND FACILITY REVIEW

## Chassis Wash

- The asphalt pavement at the bay entrance is badly damaged (Photo 76).
- Duct work is severely corroded (Photo 77).
- Insulation on the walls is badly damaged and water logged (Photo 78).
- Floor sealant has failed and needs reapplication (Photo 79).
- Radiant heaters are used to heat the space (Photo 80).
- Wash equipment is in the bay (Photo 80) and should be in a separate room to extend the life of the equipment.
- There is no vehicle lift in the bay to provide for easy access to the underside of the vehicle being washed.

**Consideration should be given to replacing the Chassis Wash Bay with a new facility that:**

- **Has concrete pavement at the entry and exit to withstand heavy bus traffic.**
- **Has corrosion resistant ductwork (like stainless steel).**
- **Has a separate room for wash equipment (which could be the same room with the wash water reclamation system).**
- **Has a parallelogram vehicle lift specifically designed to withstand a wet environment.**



Photo 76



Photo 77



Photo 78



Photo 79

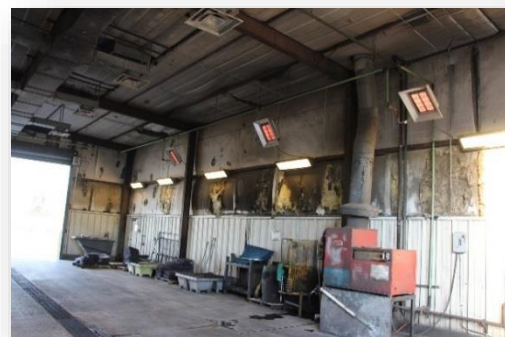

Photo 80

# EXISTING SITE AND FACILITY REVIEW

---

## ADMINISTRATION / OPERATIONS BUILDING

While this building was not included as part of the study, a few observations are offered here regarding its current condition.

### Exterior

- Exterior paint is severely faded (Photo 81).
- Possible crack in column at garage connection point (Photo 82).



Photo 81



Photo 82

### Interior

The first floor is used for storage (Photo 83) by other city departments and for the Operations Center for drivers.

The second floor is used by the IT department on the east end and is sparsely used on the west end (Photo 84)



Photo 83



Photo 84

This facility used to be the location of ABQ Ride Administration before this function was moved to the downtown transit center.

***As shown in the Concept Design section of this report, consideration should be given to demolishing this building due to its age and location of the site, which severely impacts the ability to develop efficient bus circulation on the site.***

# EXISTING SITE AND FACILITY REVIEW

## OLD BUS GARAGE

- This facility is currently used for parts storage (Photo 85), facility maintenance storage (Photo 86), and non-revenue vehicle (NRV) parking (Photo 87).
- The low vertical clearance in the facility (Photo 88), together with shorter overhead doors, limits its use as a maintenance facility and even parking for standard transit buses.
- High pressure sodium lighting (Photo 89) provides extremely poor visibility throughout the building.
- Open flame gas heaters (Photo 90) preclude the use of this facility for CNG vehicles.
- There are major cracks in the floor (Photo 91) throughout the building.
- A gas meter is located on the west side of the facility (Photo 92) between the Old Bus Garage and the Transportation Building.
- The concrete pavement on the east side of the building leading to Yale Boulevard is badly cracked (Photo 93).
- Two overhead doors on the west side are blocked, one with a roll-off dumpster (Photo 94) and one with an emergency generator (Photo 95).

***As shown in the Concept Design section of this report, consideration should be given to demolishing this building due to its age and location of the site, which severely impacts the ability to develop efficient bus circulation on the site.***



**Photo 88**



**Photo 85**



**Photo 86**



**Photo 87**

# EXISTING SITE AND FACILITY REVIEW

---



**Photo 89**



**Photo 90**



**Photo 91**



**Photo 92**



**Photo 93**



**Photo 94**



**Photo 95**

# EXISTING SITE AND FACILITY REVIEW

## NEW BUS STORAGE BUILDING

- Buses exit toward Yale Boulevard through large overhead doors (Photo 96) and a continuous curb cut.
- When the garage is full of buses, the western most buses hang out of the building and the overhead door is unable to close (Photo 97).
- There is visible cracking in building's southeast corner exterior wall (Photo 98).
- There is roof deterioration at the mechanical room on the south end of the building (Photos 99 and 100).
- Transformer and power panel for New Garage located on the building's northwest corner (Photo 101).
- The double T pre-cast concrete roof system creates pockets that could trap CNG (Photo 102).
- A special duct system (Photo 103) introduces air in each pocket of the double T roof system to blow out any fumes that might be present. Note that the lighting is explosion proof.



**Photo 96**

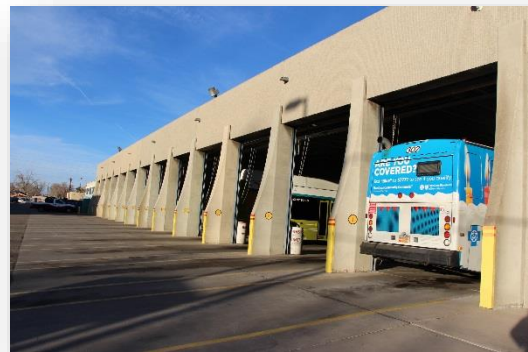

**Photo 97**

***The facility could continue to be used for vehicle parking as shown in several alternatives in the Conceptual Design section of this report.***



**Photo 98**

# EXISTING SITE AND FACILITY REVIEW

---



*Photo 99*

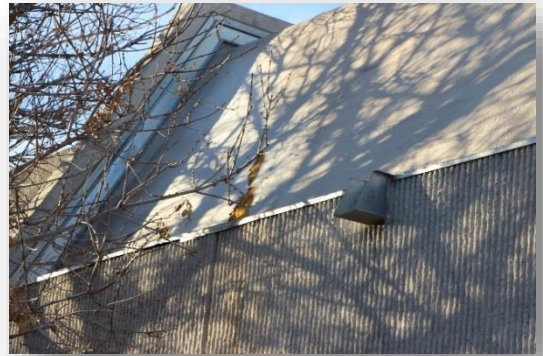

*Photo 100*



*Photo 101*

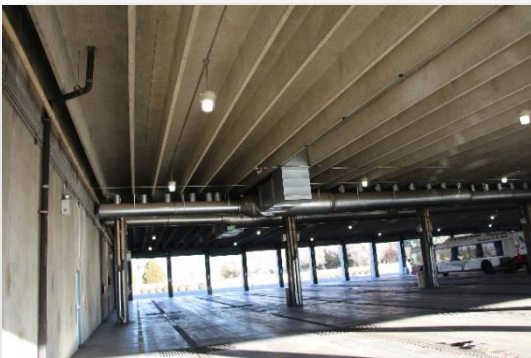

*Photo 102*

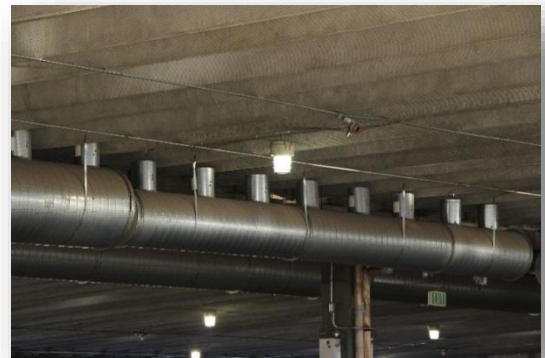

*Photo 103*

# EXISTING SITE AND FACILITY REVIEW

## OLD SUN VAN BUILDING

- Sun Van Building is in a state of extreme disrepair and not suitable for usage without major rehabilitation to all building systems. The photos below (Photos 104, 105, 106, and 107) illustrate the existing conditions.

***There was some concern that the facility may have historical significance, however, the documentation shown on the following pages indicates that there is no protected status for the building.***

***It is recommended that the facility be demolished so that the site can be more efficiently utilized.***



***Photo 104***



***Photo 105***



***Photo 106***



***Photo 107***

# EXISTING SITE AND FACILITY REVIEW

---

## Historic Significance

A review of the New Mexico Archaeological Records Management Section (ARMS) database revealed that the entire facility has been surveyed (purple color on Figure 3 below from ARMS). The “Sun Van” building was documented as a historic structure, however, it was not recommended eligible to the National Register. Therefore, there is no protected status for the building (see documentation on the next five pages). The fact that the existing Administration / Operations building and the Old Garage were not documented indicates they were not considered historic. The survey was so recent that there would probably be no need for a re-survey to support this project.

**Figure 3: ARMS Surveyed Area**





# EXISTING SITE AND FACILITY REVIEW

## Historic Cultural Properties Inventory (HCPI) Base Form (FORM 1) Historic Preservation Division, New Mexico Department of Cultural Affairs

For HPD Office use only: HCPI No. _____ District No. _____ NRHP ___ SRCP ___ Criteria ___ A ___ B ___ C ___ D		
<b>1. Name of property:</b> Commercial (HCPI No. 31506)	<b>2. Location:</b> 601 Yale SE, NE corner of Yale Facility Albuquerque, NM	<b>3. Local Reference Number:</b> Building 2
		<b>4. County:</b> Bernalillo
<b>5. Property Type:</b> <input checked="" type="checkbox"/> Building <input type="checkbox"/> Structure <input type="checkbox"/> Site <input type="checkbox"/> Object	<b>Photo:</b>	
<b>6. Date of Survey:</b> 12 / 19 / 2012		
<b>7. Previous Survey Date(s):</b> / / <input checked="" type="checkbox"/> No previous survey		
<b>8. Name of Project:</b> Yale Maintenance Project		
<b>9. UTM (NAD 83)</b> Zone: 13 Easting: 352079 Northing: 3882327		
<b>10. Photo Information</b> <b>Negative Location:</b> <b>View of:</b>		
Photos are located on an additional form.		
<b>11. Brief Description of the Property:</b> Building 2 (HCPI No. 31506) is a one-and-a-half-story, stucco-covered commercial structure with a rectangular-shaped plan. The roof is flat without any parapets observed. Under the stucco, the building is constructed of concrete block. The foundation appears to be slightly raised and is likely to be concrete. The windows on the building are fixed, some with unique security bars. Metal doors and metal with a glass transom are present. On the west elevation is a large, metal garage door, where buses can enter.		
<b>12. Who uses the property?</b>  Workers at the Yale Maintenance Facility		
<b>13. Construction Date:</b>  Date: 1960s                      ___ Known <input checked="" type="checkbox"/> Estimated    Source: Surveyor		
<b>14. Setting:</b>  ___ Suburban   ___ Rural   ___ Village <input checked="" type="checkbox"/> Urban    If Urban: ___ Commercial <input checked="" type="checkbox"/> Industrial   ___ Residential   ___ Public		
<b>15. Relationship to Surroundings:</b> <input checked="" type="checkbox"/> Similar   ___ Dissimilar		
<b>Comments:</b>		

# EXISTING SITE AND FACILITY REVIEW

HCPI Base Form (FORM 1)

(Continued from other side)

16. Additional Perspective: (Photos, drawing, footprint, etc., indicate north arrow when possible)	
	17. Surveyor: (your name, address, telephone number, and any group affiliation)  Toni R. Goar Marron and Associates 7511 Fourth Street NW Albuquerque, NM 87107  (505) 898-8848  Reviewed by Hollis P. Lawrence
	18. Owner (if known) and other knowledgeable people:  Unknown
19. Is Property Endangered? <input checked="" type="checkbox"/> Unknown <input type="checkbox"/> No <input type="checkbox"/> Yes How? Building 2 is located in the project area. No further treatment is recommended.	
20. Significance to Current Community: <input checked="" type="checkbox"/> Unknown <input type="checkbox"/> None <input type="checkbox"/> Low <input type="checkbox"/> Moderate <input type="checkbox"/> High  Describe:	
21. Other Significance or Information of Interest: (such as historical, legendary, structural, former ownership, etc.)	
22. National or State Register:  Is this property individually listed on a historic register? <input type="checkbox"/> Unknown <input checked="" type="checkbox"/> No <input type="checkbox"/> Yes If yes: <input type="checkbox"/> State <input type="checkbox"/> National  If 'no' or unknown, do you think this property is eligible for listing? <input checked="" type="checkbox"/> No <input type="checkbox"/> Yes Why? Building 2 is a commercial type structure that is part of the Yale Maintenance Facility. The building is in relatively good condition and does not appear to have any significant modifications. It is in good condition. In addition, the structure fails to typify an architectural style, and it is not the work of a master. The building is therefore recommended not eligible to the NRHP.	
23. National or State Historic District:  Is this property in a historic district? <input type="checkbox"/> Unknown <input checked="" type="checkbox"/> No <input type="checkbox"/> Yes If yes: <input type="checkbox"/> Contributing <input type="checkbox"/> Non-contributing <input type="checkbox"/> Unknown  If 'yes', what is the name of the district? _____ <input type="checkbox"/> State <input type="checkbox"/> National	
24. Supplemental Forms:  <input type="checkbox"/> None <input type="checkbox"/> HCPI Detail Form (FORM 2) <input checked="" type="checkbox"/> Continuation Sheets, # pages: <u>1</u>	

# EXISTING SITE AND FACILITY REVIEW

---

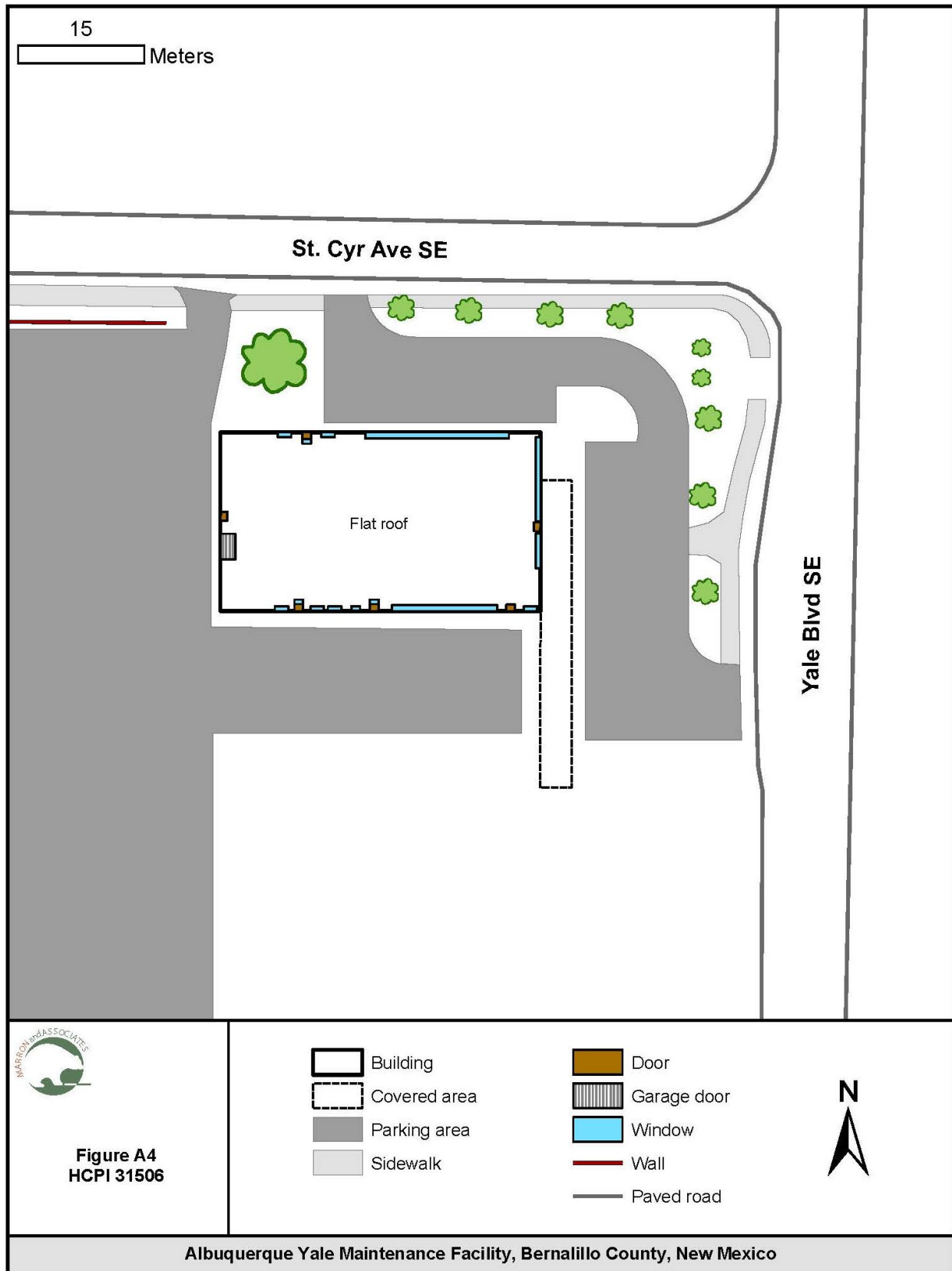

Figure – Building 2, South and West Elevations

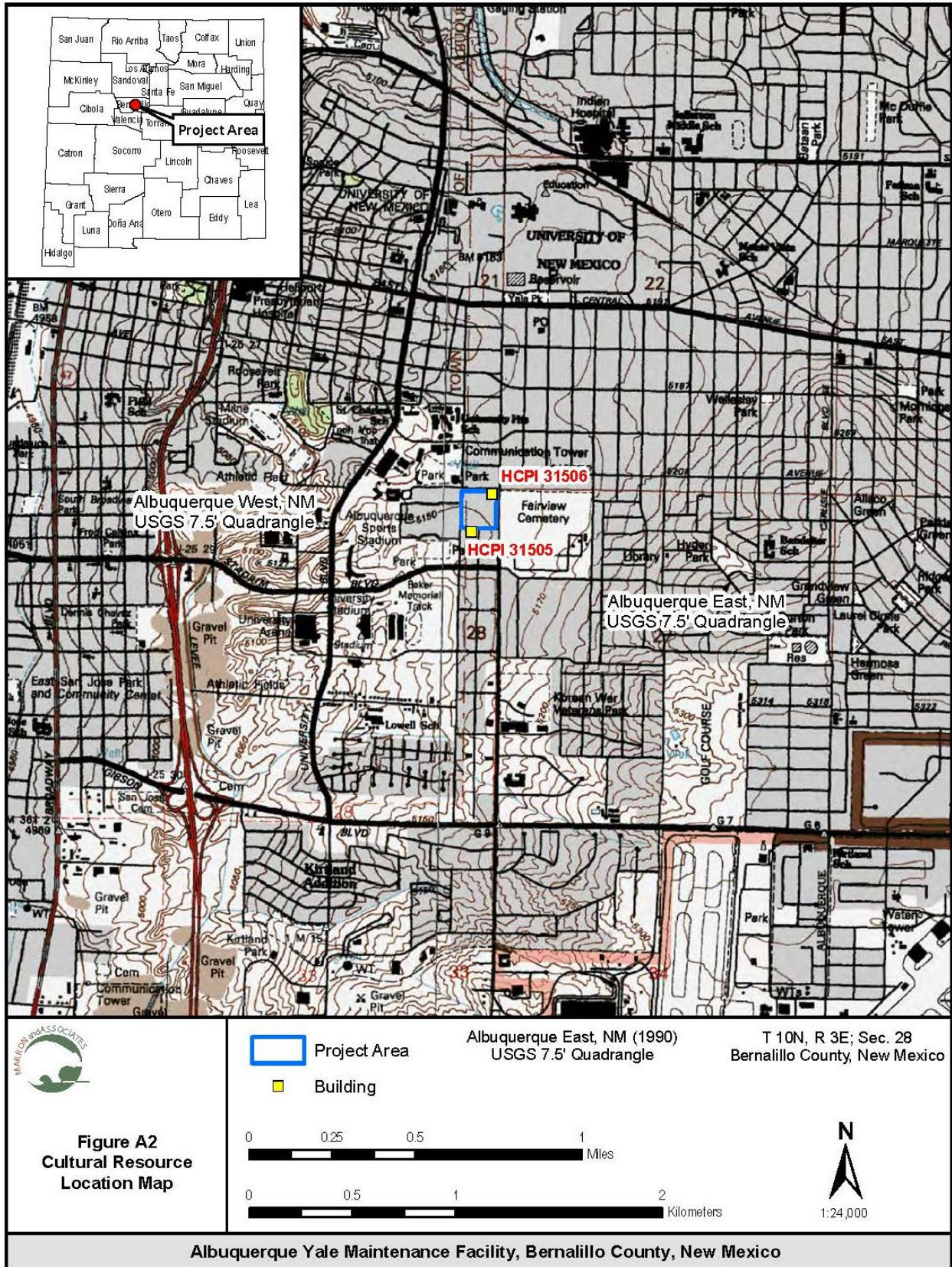

Figure – Building 2, West Elevation

# EXISTING SITE AND FACILITY REVIEW



# EXISTING SITE AND FACILITY REVIEW



**Figure A2**  
Cultural Resource  
Location Map

Albuquerque Yale Maintenance Facility, Bernalillo County, New Mexico

# **EXISTING SITE AND FACILITY REVIEW**

---

**THIS PAGE LEFT INTENTIONALLY BLANK**



---

**DESIGN CRITERIA**





# GENERAL CONSIDERATIONS

---

## ACKNOWLEDGMENTS

The study team would like to thank the following ABQ Ride staff members that participated in the interviews for their time and input which made possible the development of the data contained herein.

### ABQ Ride

Bruce Rizzieri----- Director  
Annette Paez----- Associate Director

### Yale and Daytona Facilities

Jim Carrillo-----Maintenance Manager  
James Bird----- Asst. Maintenance Manager  
Nick Cordova----- Building Supervisor  
Randy Jiron----- Materials Manager  
Stan Low ----- IT Division Manager  
Joe Saraphon----- IT Program Manager  
Steve Cordero ----- Transit Service Specialist  
Stephen Meyehlein ----- Shop Supervisor  
Jesus Torres ----- Swing Shift Supervisor  
Jason Black ----- Vehicle Service Supervisor

### Study Team

#### Parsons Brinckerhoff

Mark Probst-----Project Manager  
Mike Martin ----- Planner

# GENERAL CONSIDERATIONS

---

## BACKGROUND

ABQ RIDE provides transit service to the Albuquerque metropolitan area with 21 regular fixed routes, 15 commuter routes, 3 Rapid Ride routes, and one downtown circulator. This service is operated out of two facilities, the older Yale Maintenance and Operations Facility and the newer Daytona Maintenance and Operations Facility. The current fleet of 160 transit buses is split between the two facilities.

In addition, the Daytona Facility has the paratransit fleet. Note that CNG fueling is only available at the Yale Facility. A fleet of 21 new forty foot CNG buses was recently delivered to replace some of the older forty foot CNG buses in the fleet.

The Daytona Facility operates 24 hours a day, 7 days a week. The Yale Facility operates 18 hours a day, 5 days a week.

ABQ RIDE wants to evaluate the Yale Facility at 601 Yale Boulevard, SE to determine how it can best be utilized to accommodate the current and projected fleet. The evaluation will also identify what upgrades should be made to the facility over the next 10 years. Note that this is intended to be an overall evaluation and not a detailed analysis of the building systems and components.

The project includes the following facilities at the Yale Facility:

- Maintenance Facility
- Fuel and Wash Facilities
- Agency Vehicle Parking
- Employee / Visitor parking

The Operations (Drivers) Facility is not part of the study.

# GENERAL CONSIDERATIONS

---

## INTRODUCTION

This document contains the criteria for the assessment of the Yale Maintenance Facility and defines the necessary spaces and requirements for operational efficiencies, providing the foundation for preliminary design. The information gathered in the design criteria is organized in the following chapters:

- **Chapter 1: General Considerations.** Lists pertinent information that influences design.
- **Chapter 2: Space Needs Program.** Delineates the space requirements for offices, maintenance bays & shops, support spaces, parts storage, vehicle/equipment storage, and fuel & wash facilities.
- **Chapter 3: Functional Requirements.** Presents the functional requirements for offices, maintenance bays & shops, support spaces, parts storage, vehicle/equipment storage, and fuel & wash facilities.
- **Chapter 4: Site & Building Requirements.** General design criteria relating to architecture, structure, mechanical, electrical, civil, and landscaping, as well as security, signage/graphics, and waste handling issues.
- **Appendices:** Includes sign – in sheets listing the individuals interviewed in various meetings, fleet inventory, fleet projections, and system capacity calculations.

The following is a detailed outline of the Parsons Brinckerhoff (PB) Team approach to the Yale Maintenance Facility Assessment.

# GENERAL CONSIDERATIONS

---

## METHODOLOGY

The first step in the Yale Maintenance Facility Assessment is to gain a thorough understanding of the operational characteristics and functional needs of each department that may be located on the site. Methods used to gain this knowledge included personal interviews with ABQ Ride employees that may be affected by this project, on-site observations, and review of existing documents relative to this project. The flow chart below illustrates the project approach being used to develop the Yale Facility Master Plan.

**Exhibit 1.1: Typical Project Flow**

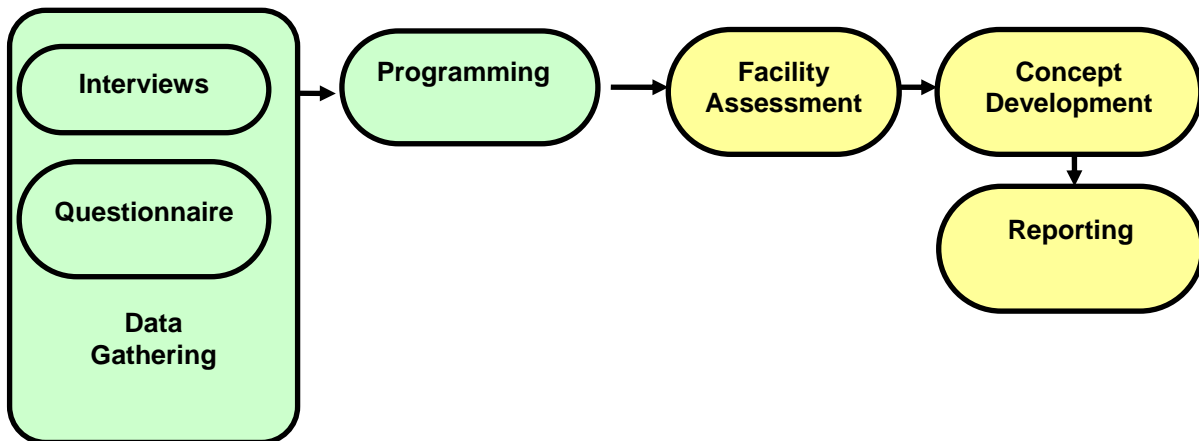

**Interviews:**

In-depth interviews were conducted to gain full knowledge of the inner workings of the system. During this interview stage the study team worked closely with ABQ Ride staff to objectively define maintenance techniques, policies, procedures, and equipment requirements.

**On-site Observations:**

On-site observations are a direct way to understand current operations which allows for early diagnosis of problems / opportunities and, coupled with the interviews, provides a well rounded sense of what is needed for the overall success of the project.

# GENERAL CONSIDERATIONS

---

<b>Programming:</b>	The Programming document provides Preliminary Space Needs Program and Functional Requirements data that defines the areas (sq. ft.) involved with specific functions as well as provides graphical representations on how those spaces can be organized.
<b>Facility Assessment:</b>	The Facility Assessment is based on the study team's on-site observations and drawings and information supplied by ABQ Ride related to the existing and projected facilities, fleet, and staff levels. The Yale Maintenance Facility will be reviewed to determine the size, condition, expansion capability, efficiency, and adherence to applicable codes.
<b>Concept Development:</b>	Based on the existing facility assessment and the program requirements, alternative concepts are developed to determine the best use of the Yale Facility to support the current and projected fleet. Concepts are reviewed with key ABQ staff and a concept is selected and refined. Based on the selected concept design, a preliminary estimate of probable construction cost is developed.
<b>Reporting:</b>	At the conclusion of the project, a final report will be developed which includes the Yale Maintenance Facility Assessment, sketches of the studied design alternatives, and selected concept design with estimated construction costs in a unified document for presentation to key project stakeholders and City of Albuquerque staff.

# GENERAL CONSIDERATIONS

---

## DAILY ACTIVITIES

This section is intended to provide a basic understanding of the day-to-day operations and maintenance activities that take place at the Yale Facility.

Operators responsible for driving the morning service arrive in the early morning hours and park their private vehicles in the Employee Parking Area. They report and receive their assignments and instruction from the desk supervisor. They proceed to the bus parking area and perform a pre-trip inspection of the vehicle prior to leaving on their route. When drivers return to the site, they park in a designated bus parking area and perform their post trip inspection. Drivers then file necessary reports with the desk supervisor. Service personnel will move buses from the bus area through Fuel & Wash, and fare retrieval, and return to a designated parking area.

Beginning and ending of shifts generate considerable transit vehicle and automobile traffic on and around the site. Moving vehicles for maintenance, inspection, fuel & wash, and other related repairs generates additional on-site traffic. The greatest amount of intra-site traffic will occur in the evening hours between 3:30 p.m. and 12:00 a.m. During this time, service personnel will drive vehicles through the Fuel Island, Bus Wash, and into Maintenance for repairs or inspections. Separation of bus and personnel traffic is desirable for safety.

Maintenance personnel will work on two shifts performing varied tasks five (5) days per week. The facility will house general maintenance, inspection, tire, brake, parts distribution, and other daily maintenance functions.

During all shifts all maintenance activities will be performed. During the evening shift, personnel assigned to Fuel & Wash sweep out the interiors of vehicles, replenish engine oil and coolant levels, fill the fuel tanks, and perform a visual inspection of the vehicle exterior noting defects that require immediate attention. After sweeping out the interior, fueling, and topping off lubricants, the service worker drives the vehicle through the vehicle washer. If the vehicle requires repair or is scheduled for inspection, it will be parked in a designated area. If no work is required, the vehicle will be returned to the regular parking area and the service worker begins the process again with the next vehicle. Note that the facility design should provide flexibility to allow all maintenance activities to be performed on all shifts.

Vehicles awaiting repair will be cycled through Running Repair bays based on work orders generated from defect reports, road calls, accidents, and warranty problems. Items found during scheduled preventive maintenance repairs (PM's) are addressed before the bus is returned to service. By

# GENERAL CONSIDERATIONS

---

preference, the majority of repairs should be performed on a scheduled basis, but there will always be a certain level of on-going repair work required by failures and incidents.

Inspections are performed on a scheduled basis established by mileage intervals and seasonal requirements. A vehicle has its engine cleaned in the Chassis Wash prior to inspection or other service, allowing sufficient time for leaks to become apparent. Inspectors are responsible for inspection, lubrication, and minor repairs. Should a vehicle need additional repair based upon inspection findings, it will remain in the bay until the repairs are made.

## **ON-SITE TRAFFIC MOVEMENT**

The mixing of moving vehicles and employees on the site must be carefully considered and incorporated into the overall traffic pattern. Pedestrian walkways must be safely and efficiently located and readily identifiable to promote effective management and the enforcement of safety standards. This section identifies many of the areas where vehicles and pedestrians mingle. Transit vehicles delivery trucks, service vehicles, forklifts, and the privately owned vehicles of staff personnel are assigned to parking or staging areas around the site. An explanation of how vehicles will be parked and staged follows.

### **Agency Vehicle Traffic**

Transit vehicles enter the site and are parked in the agency vehicle parking (staging) area. Vehicles move from Parking to Repair, Fuel & Wash, Inspection, and other maintenance areas as shown on the following page. Careful consideration should be given to reduce backing movements wherever possible. If backing movements are required, they should be limited to times when the vehicle is being driven by Service personnel.

Note that Exhibit 1.2 on the following page illustrates the traffic flow that should be accommodated at the Yale Facility.

# GENERAL CONSIDERATIONS

**Exhibit 1.2: Transit Vehicle Traffic Flow**

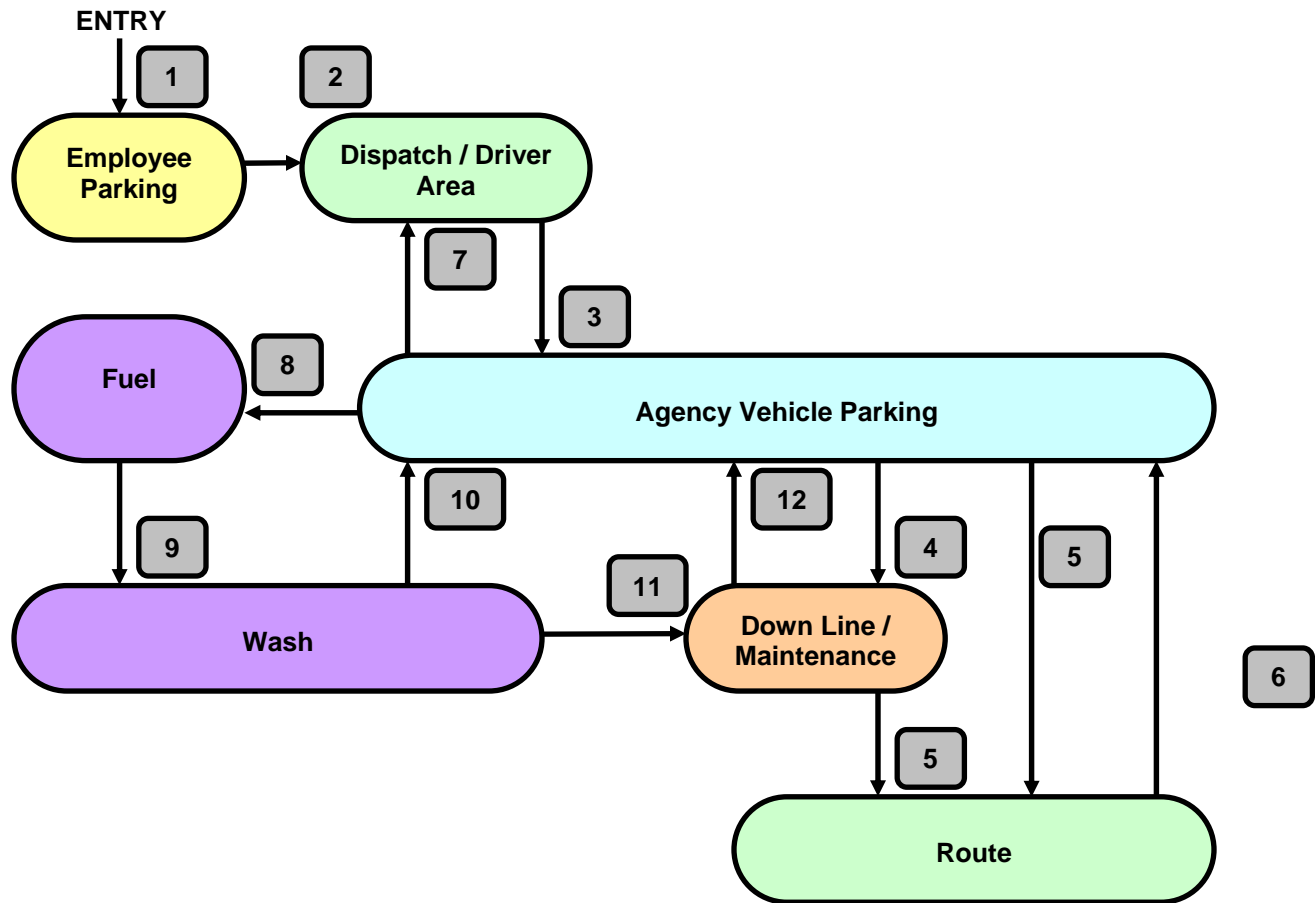

1. Operator arrives on site and parks in employee parking area.
2. Operator picks up route information at the Dispatch Center.
3. Operator gets bus assignment at dispatch near Bus Parking area. Operator performs a pre-trip inspection in the Agency Vehicle Parking area to check lights, brakes, tires, and cleanliness. The bike rack is cycled in the bus parking spot. The wheelchair lift is cycled in the bus parking lot.
4. If a problem is found with the bus, it is taken to maintenance for immediate repairs.
5. Bus leaves site and goes on route.
6. Buses returning to the site are currently parked in a staging area before getting to the fuel facility. (Ideally buses would be parked in the parking area to eliminate separate staging and improve efficiency)
7. Operator reports in to Dispatcher and typically leaves the site.
8. Service worker picks up bus and drives to the Fuel / Wash area and fuels the vehicle and tops off fluids. Bus interior is also cleaned in this area. The fare box vault is also pulled and fares are collected while in the fuel lane.
9. Bus is taken through the Wash area for exterior cleaning.
10. If no problems are reported bus is returned to assigned area in Bus Parking.
11. If a problem is reported or service is scheduled; bus is parked in Down Line for maintenance.
12. After maintenance, bus is returned to Bus Parking area.

**Note: Traffic flow should ideally be in a counterclockwise direction.**



# GENERAL CONSIDERATIONS

---

## **Support Vehicles**

Traffic other than transit vehicles, (forklifts, delivery trucks, off site agency vehicles servicing site and private non-agency service vehicles) circulates between designated parking areas and the maintenance, service, yard storage, and on site waste water treatment buildings.

## **Employee Vehicular Traffic**

Vehicles of employees should be restricted to employee parking areas. Employee parking areas should be located on the site in close proximity to their respective entrances to the Drivers' Room in Operations and to the restroom/lockers areas in Maintenance.

## **Commercial Vehicular Traffic**

Commercial vehicles must be directed onto and from the site by appropriate signs, following the same traffic flow as transit vehicles. Those vehicles delivering bulk consumables, such as fuels and engine oil, require off-loading adjacent to the tank farm or adjacent to the Lube Room. Tanker trucks may also arrive to evacuate tanks and collect recyclable liquids. Vehicles will pick up trash from Fuel & Wash and from dumpsters and roll-off receptacles / containers placed around the site. Scrap dealers may enter the site to pick up segregated and non-segregated metal scrap as well as tires.

Other companies providing services, products, or a combination of both may create additional traffic, e.g., delivery of tires, delivery of advertising materials for the exterior and interior of vehicles, laundry service, bulk storage, and service contracts with companies maintaining specific plant equipment.

## **Pedestrian Traffic**

Routine activities generate a substantial volume of pedestrian traffic. Many of these trips require maintenance personnel to walk the length of the bus parking area to pick up a vehicle or to return to a workstation after parking a vehicle. Pedestrian walkways should be designed to minimize walking distances, trip times, and exposure of personnel to vehicular traffic. Those areas personnel most frequently walk to or through are:

- From the Employee Parking Area to the entrance doors of Maintenance.
- From the Employee Parking Area to the entrance door of the Drivers' Room.
- From the Drivers' Room to the Agency Vehicle Parking Area.
- From Maintenance to Fuel & Wash.
- From Fuel & Wash to the Agency Vehicle Parking Area.
- From the Maintenance Area to the Agency Vehicle Parking Area.

# **GENERAL CONSIDERATIONS**

---

**THIS PAGE LEFT INTENTIONALLY BLANK**



---

**SECTION 2: SPACE NEEDS PROGRAM**



# SPACE NEEDS PROGRAM

---

## INTRODUCTION

The Space Needs Program presented in this section was developed based on detailed interviews with the ABQ Ride staff regarding the functional requirements and operating characteristics of the Yale Maintenance Facility.

The space requirements shown for each function are net useable area. A circulation factor is applied to the total net useable area to arrive at a gross square footage requirement. In addition to circulation, the factor provides for spaces such as mechanical and electrical chases, structures, width of walls, stairs, and elevators. The Space Needs Program begins with a summary followed by a detailed program for each functional area. Note that the functional requirements for each space are delineated in Chapter 3 in the same order in which they appear in the Space Needs Program.

The program includes the following information for each space:

### **Space Name**

A description of the space.

[E] = Enclosed

[O] = Open office

[A] = Alcove

[C] = Canopy covered

[x] = Outdoor

### **Space Standard**

The standard for each space based on the function, equipment, and furnishings to be accommodated. The standards are given in square feet. Where the configuration of the space is critical, dimensions are given for the space. The size of the repair bays are commonly accepted industry standards.

# SPACE NEEDS PROGRAM

---

<b>Reference</b>	Gives page number in Chapter 3 (Functional Requirements) which provides additional information about space
<b>Quantity</b>	Identifies the number of spaces to be accommodated.
<b>Area</b>	Lists the space allocated for a given function in square feet. Where a space standard is provided, the space equals the quantity times the space standard.
<b>Remarks</b>	Lists pertinent design information.

Quantity and area are given for the Existing Yale and Daytona Facilities where readily available and for Options 1 and 2 for the Yale Facility.

The fleet size and mix is given at the top and, for the options, are based on discussions with ABQ staff regarding probable impact on deadhead cost and site capacity. See Appendix D for Fleet Projections and Appendix E for the Capacity Analysis of the Yale and Daytona Facilities. Note that the options shown in the space program are based on the fleet size and mix projected for 2030.

Probable impact on deadhead cost indicates that:

1. The paratransit fleet should be split evenly between the Yale and Daytona facilities.
2. The articulated fleet can be operated out of either facility. The assumption in Option 1 is that the entire projected articulated bus fleet of 60 vehicles will operate out of the Daytona Facility due to its current capacity of at least 90 articulated buses. Option 2 assumes half of the projected articulated bus fleet (30 buses) will operate out of the Yale Facility. Note that this approach will give ABQ Ride the flexibility to operate articulated buses out of either facility.

At the end of the space program is a listing of the existing staffing at each facility and the factors used to project staffing needs in the future. These factors were used in the space needs program to calculate employee parking spaces.

**Preliminary Space Program**

Space Standard	Ref.	Existing			Yale Facility Options			Remarks	
		Yale Qty	Yale Area	Daytona Qty	Daytona Area	Option 1 Qty	Option 1 Area		Option 2 Qty
<b>Fleet Size and Mix</b>									
Fixed Route (40') Diesel/Hybrid		37	78	52		50		20	
Fixed Route (40') CNG		41		0					
Artic/BRT (60') Diesel/Hybrid		0	0	24		0		30	
Artic/BRT (60') Diesel		0		0					
Paratransit (22' to 26') Gasoline		0		69				70	
Non-Revenue Vehicles (NRV) Gasoline		20		??				20	
<b>SUMMARY</b>									
Maintenance Office/Support						5,426		5,426	
Bays and Shops						27,816		32,496	
<b>Total Maintenance</b>						<b>33,242</b>		<b>37,922</b>	
Materials Management						5,665		5,665	
<b>Subtotal Maintenance &amp; Materials Management Bldg.</b>						<b>38,907</b>		<b>43,587</b>	
Fuel Facility						6,664		6,664	
Wash Facility						8,360		8,800	
<b>Facility Maintenance</b>						<b>6,178</b>		<b>6,178</b>	
<b>Total Building Area</b>						<b>60,109</b>		<b>65,229</b>	
Parking and Site Areas									
Agency Vehicle Parking						74,987		85,151	
Private Vehicle Parking						75,250		75,250	
Other Site Areas						6,521		6,521	
<b>Total Parking and Site Areas</b>						<b>156,758</b>		<b>166,922</b>	
Subtotal Building, Parking, and Site Areas						<b>216,867</b>		<b>232,151</b>	
Site Circulation	50%					108,434		116,076	
Landscaping	5%					10,843		11,608	
Stormwater Management	5%					10,843		11,608	
<b>TOTAL SITE AREA</b>						<b>319,000</b>		<b>371,443</b>	
	Acres					<b>7.32</b>		<b>8.53</b>	

Assuming all on one level

**Preliminary Space Program**

	Space Standard	Ref.	Existing			Yale Facility Options			Remarks	
			Yale Qty	Yale Area	Daytona Qty	Daytona Area	Option 1 Qty	Option 1 Area		Option 2 Qty
<b>Fleet Size and Mix</b>										
Fixed Route (40') Diesel/Hybrid	12 x 16	192	2.3.3	37	78	52		50	20	
Fixed Route (40') CNG	12 x 14	168	2.3.4	41		0				
Artic/BRT (60') Diesel/Hybrid	14 x 16	224	2.3.5	0	0	24		0	30	
Artic/BRT (60') Diesel	10 x 12	120	2.3.6	0		0				
Paratransit (22' to 26') Gasoline	10 x 15	150	2.3.7	0		69		70	70	
Non-Revenue Vehicles (NRV) Gasoline	-	-	-	20		??		20	20	
<b>MAINTENANCE</b>										
<b>Office/Support</b>										
Maintenance Manager	12 x 16	192	2.3.3					192	1	192
Assistant Maintenance Manager	12 x 14	168	2.3.4					168	1	168
Maintenance Supervisor	14 x 16	224	2.3.5					224	1	224
Administrative Assistant	10 x 12	120	2.3.6					120	1	120
Copier / Print Room	10 x 15	150	2.3.7					150	1	150
Reference Library										Not needed
Maintenance Lunch Room	16 x 25	400	2.3.8					400	1	400
Vending/Kitchenette	10 x 15	150	2.3.9					150	1	150
Training Room	20 x 25	500	2.3.10					500	1	500
Women's Restroom/Locker/Shower		200	2.3.11					200	1	200
Men's Restroom/Locker/Shower		350	2.3.11					350	1	350
Laundry Room (Clean)	6 x 10	60	2.3.12					60	1	60
Laundry Room (Dirty)	6 x 10	60	2.3.12					60	1	60
Custodial Room	8 x 10	80	2.3.13					80	1	80
IT / Telecommunications Room	10 x 15	150	2.3.13					150	1	150
Mechanical Room	-	-	1,000					1,000	1	1,000
Electrical Room	-	-	250					250	1	250
Fire Riser Room	8 x 15	120	2.3.15					120	1	120
	-	-	-					-	0	-
Subtotal								4,174		4,174
Circulation Factor		30%						1,252		1,252
<b>TOTAL OFFICE / SUPPORT</b>								5,426		5,426



**Preliminary Space Program**

Space Standard		Ref.

Existing		
Yale	Daytona	
Qty	Area	Qty
37	78	52
41	0	0
0	0	24
0	0	24
0	0	69
20	??	??

Yale Facility Options			
Option 1		Option 2	
Qty	Area	Qty	Area
	50		20
4	4,400	1	1,100
0	-	3	4,500
6	4,320	6	4,320
70		70	
20		20	

**Fleet Size and Mix**  
 Fixed Route (40') Diesel/Hybrid  
 Fixed Route (40') CNG  
 Artic/BRT (60') Diesel/Hybrid  
 Artic/BRT (60') Diesel  
 Paratransit (22' to 26') Gasoline  
 Non-Revenue Vehicles (NRV) Gasoline

Category	Qty	Area	Daytona Qty	Daytona Area	Option 1 Qty	Option 1 Area	Option 2 Qty	Option 2 Area	Remarks
<b>Bays and Shops</b>									
General Repair Bays (incl. PM & RR)									
Standard	[O] 20 x 55	1,100							
Artic	[O] 20 x 75	1,500							
Paratransit/NRV	[O] 18 x 40	720							
Catwalk Bay (count as General Repair Bay)									
Standard	[O] 1		1						
Artic	[O] 0		1						To be located at Daytona with Component Rebuild
Component Exchange Bay (count as General Repair Bay)									
Standard	[O] 0		1						
Artic	[O] 0		1						
Alignment Bay (one per facility)									
Standard	[O] 20 x 55	1,100							
Artic	[O] 20 x 75	1,500							
Tire Repair Bay (one per facility)									
Standard	[O] 20 x 55	1,100							
Artic	[O] 20 x 75	1,500							
Tire Shop	[O] 20 x 30	600							
Tire Storage	[O] 20 x 55	1,100							
Common Work Area	[O] 25 x 50	1,250							
Component Rebuild (Unit Shop)									
Brake Shop	[O] 20 x 30	600							
Electronics / Farebox Repair Shop	[E] 20 x 20	400							
Body Repair Bay									
Standard	[O] 20 x 55	1,100							
Artic	[O] 20 x 75	1,500							
Paint Prep / Body Repair Bay									
Standard	[O] 30 x 55	1,650							
Artic	[O] 30 x 75	2,250							
Paint Booth									
Standard	[E] 30 x 60	1,800							
Artic	[E] 30 x 90	2,700							
Welding / Body Shop	[E] 30 x 50	1,500							
Battery Charging Room	[E] 18 x 20	360							
Lube/Compressor Room	[E] 20 x 20	400							
Portable Equipment Storage	[O] - x -	1,000							
Tool Box Storage	[O] - x -	500							
	- x -	-							
	- x -	-							
Subtotal									
Circulation Factor		20%							
<b>TOTAL BAYS AND SHOPS</b>									

Subtotal	23,180	27,080
Circulation Factor	4,636	5,416
<b>TOTAL BAYS AND SHOPS</b>	<b>27,816</b>	<b>32,496</b>



	Space Standard		Ref.	Existing			Yale Facility Options			Remarks	
	Qty	Area		Yale Qty	Yale Area	Daytona Qty	Daytona Area	Option 1 Qty	Option 1 Area		Option 2 Qty
<b>Fleet Size and Mix</b>											
Fixed Route (40') Diesel/Hybrid				37	78	52	0	52			
Fixed Route (40') CNG				41	0	0	24	0	50	20	
Artic/BRT (60') Diesel/Hybrid				0	0	24	0	24	0	30	
Artic/BRT (60') Diesel				0	0	0	69	0	70	70	
Paratransit (22' to 26') Gasoline				20		??			20	20	
Non-Revenue Vehicles (NRV) Gasoline											
<b>WASH FACILITY</b>											
Automatic Bus Washer	[E]	20 x 80	1,600	2.3.78		1		1	1,600	1	1,600
Water Reclaim / Wash Equipment Room	[E]	15 x 80	1,200	2.3.78					1,200	1	1,200
Chassis Wash / Steam Clean Bay											
Standard	[E]	20 x 55	1,100	2.3.80		1	0	0	1,100	1	1,100
Artic	[E]	20 x 75	1,500	2.3.82		0	1	1	1,500	1	1,500
Detail Clean Position											
Standard	[C]	20 x 55	1,100	2.3.84					2,200	1	1,100
Artic	[C]	20 x 75	1,500	2.3.86		2	2		-	1	1,500
											Existing are outdoors
Subtotal									7,600		8,000
Circulation Factor			10%						760		800
<b>TOTAL WASH FACILITY</b>									8,360		8,800
<b>FACILITY MAINTENANCE (assumes centralized at Yale)</b>											
Supervisor Office (Facility Maintenance) - for 2	[E]	14 x 16	224	2.3.89					224	1	224
Supervisor Office (Bus Stop) - for 2	[E]	14 x 16	224	2.3.90					224	1	224
Crew Room (20 people)	[E]	20 x 25	500	2.3.91					500	1	500
Reference Library	[E]	10 x 15	150	2.3.92					150	1	150
Facility Maintenance and Bus Stop Shop	[E]										
Welding Area (shared with Vehicle Maintenance)	[O]	20 x 40	800	2.3.94					800	1	800
Fabrication/Assembly Area	[O]	20 x 40	800	2.3.94					800	1	800
Carpentry Area	[O]	20 x 40	800	2.3.94					800	1	800
Material Storage (adjacent to Parts Storeroom)	[E]	20 x 50	1,000	2.3.96					1,000	1	1,000
Tool Crib (shared with Vehicle Maintenance, if possible)	[E]	10 x 15	150	2.3.96					150	1	150
Portable Equipment Storage	[E]	20 x 25	500	2.3.97					500	1	500
Subtotal									5,148		5,148
Circulation Factor			20%						1,030		1,030
<b>TOTAL FACILITY MAINTENANCE</b>									6,178		6,178



**Preliminary Space Program**

	Space Standard		Ref.	Existing			Yale Facility Options			Remarks	
	Qty	Area		Yale Qty	Yale Area	Daytona Qty	Daytona Area	Option 1 Qty	Option 1 Area		Option 2 Qty
<b>Fleet Size and Mix</b>											
Fixed Route (40') Diesel/Hybrid	37	78		52	0	52		50		20	
Fixed Route (40') CNG	41	0		0	0	0					
Artic/BRT (60') Diesel/Hybrid	0	0		24	0	24		0		30	
Artic/BRT (60') Diesel	0			0	0	0					
Paratransit (22' to 26') Gasoline	0			69		69				70	
Non-Revenue Vehicles (NRV) Gasoline	20			??		??				20	
<b>OTHER SITE AREAS</b>											
Guard House	[E]	8 x 16	128	2.3.101				128	1	128	
Emergency Generator	[X]	10 x 20	200	2.3.101				200	1	200	
Yard Storage											
Bus Stop (shelters, poles, benches, trash containers)	[X]		5,000	2.3.102				5,000	1	5,000	
Dumpster											
Waste Tires	[C]	10 x 20	200	2.3.102				200	1	200	
Trash	[C]	10 x 20	200	2.3.102				200	1	200	
Recycle	[C]	10 x 20	200	2.3.102				200	1	200	
Subtotal								5,928		5,928	
Circulation Factor			10%					593		593	
<b>TOTAL OTHER SITE AREAS</b>								<b>6,521</b>		<b>6,521</b>	

**STAFFING**

Maintenance		0	1
Maintenance Manager		1	1
Assistant Maintenance Manager		2	2
Supervisors		3	9
Lead Techs		2	5
Mechanic III		9	21
Mechanic II		1	2
Welder/Fabricators III		1	2
Paint/Body II		1	2
Electronics Techs		0	3
Parts Workers		2	2
Vehicle Servicers		6	13
Tire Person		1	1
Vault Pullers		1	2
Custodians		4	6
<b>Subtotal</b>		<b>32</b>	<b>71</b>
Facility Maintenance			
HVAC		0	1
Signs and Markings Worker II		2	2
Building Maintenance Worker		1	0
General Service Worker		1	1
Laborer Worker		1	0
<b>Subtotal</b>		<b>5</b>	<b>4</b>
Operations			
Fixed Route (see note 1)		98	142
Sun Van Chauffers		0	83
<b>Subtotal</b>		<b>98</b>	<b>225</b>

2.44 buses per person at Yale  
2.04 buses per person at Daytona

1.26 people per fixed route vehicle at Yale  
1.87 people per fixed route vehicle (including Sun Van supervisors and office staff)  
1.2 people per Sun Van vehicle

Note 1: Includes Supervisors, Office Staff, and Operators

THIS PAGE LEFT INTENTIONALLY BLANK



---

## SECTION 3: FUNCTIONAL REQUIREMENTS





# FUNCTIONAL REQUIREMENTS

---



## INTRODUCTION

The design criteria presented in this section consists of Functional Relationship Diagrams and Functional Area Modules. The Functional Relationship Diagrams illustrate the relationships between areas listed in the Space Needs Program. The Functional Area Modules consist of a graphical depiction along with specific design criteria for each of the spaces listed in the Space Needs Program.





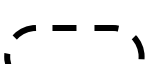
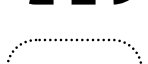

### **Diagrams**

The relationships between various functional areas of the Space Needs Program are conveyed in the diagrams on the following pages. These diagrams are not meant to be floor plans, only representational relationship diagrams.

#### Line Type Key

	Enclosed Spaces
	Open Spaces or Alcoves
	Exterior / Covered Spaces
	Area of associated spaces

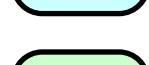
#### Color Key

	Office / Administrative Spaces
	Shops / Workspaces
	Circulation / Public / MEP Spaces
	Storage / Equipment Spaces
	Driver / Crew Areas
	Bay Spaces (Vehicle)

# FUNCTIONAL REQUIREMENTS

## MAINTENANCE – OFFICE / SUPPORT

### FUNCTIONAL RELATIONSHIPS

The relationships between the various functional areas within this section are shown below. The design should accommodate these relationships in order to maximize operational efficiency. This diagram is not meant to be a floor plan, only a representational relationship diagram.

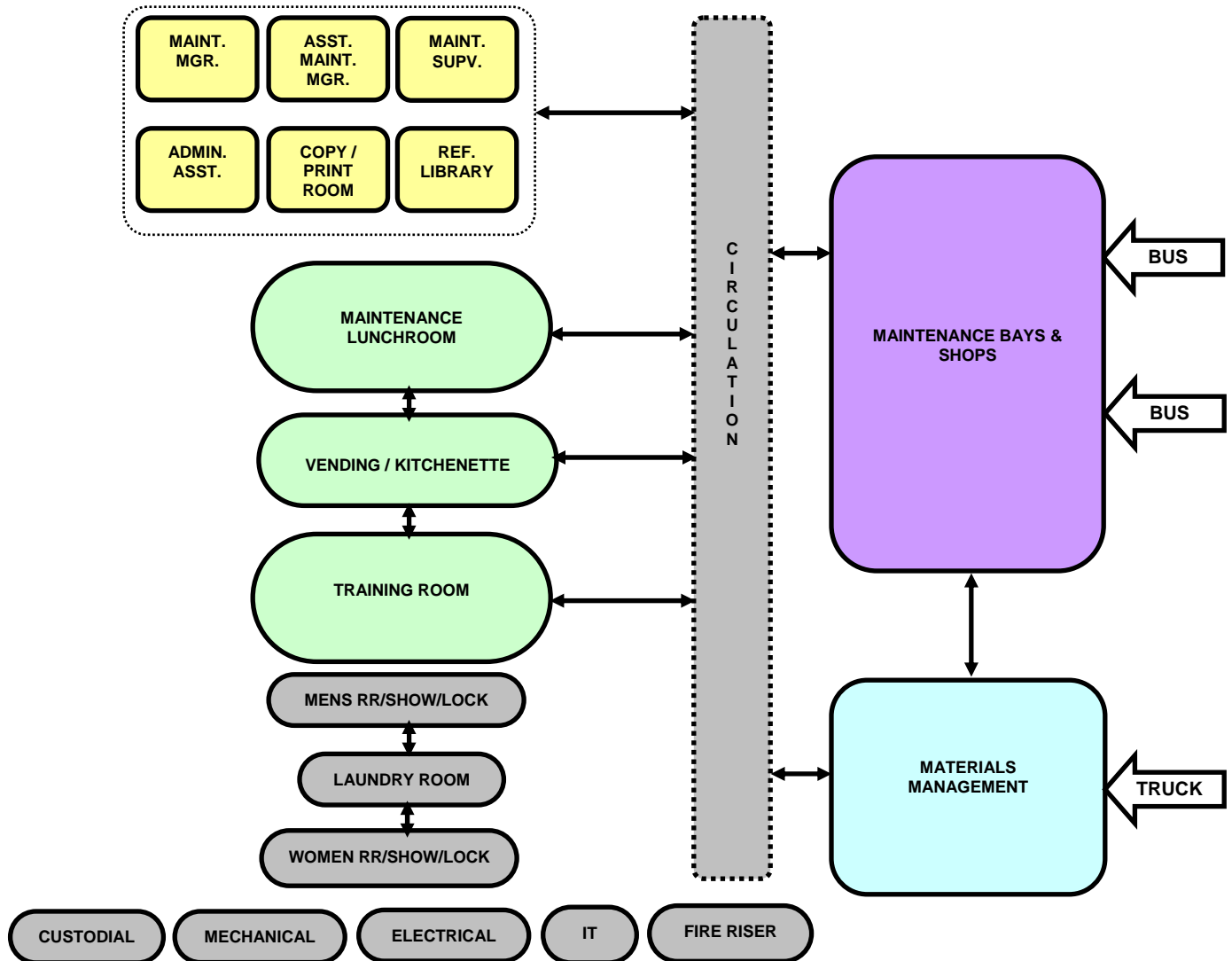

### FUNCTIONAL AREA MODULES

Each functional area within this section has been individually defined as a module. Each module has information regarding the function of the space, relationships to other areas, critical dimensions (if any), equipment/furnishings, and finishes. Technical considerations for ventilation, mechanical, plumbing, and electrical are also defined. The Equipment List takes precedence over equipment shown in modules.

# FUNCTIONAL REQUIREMENTS

## Maintenance Manager

(Maintenance – Office/Support)

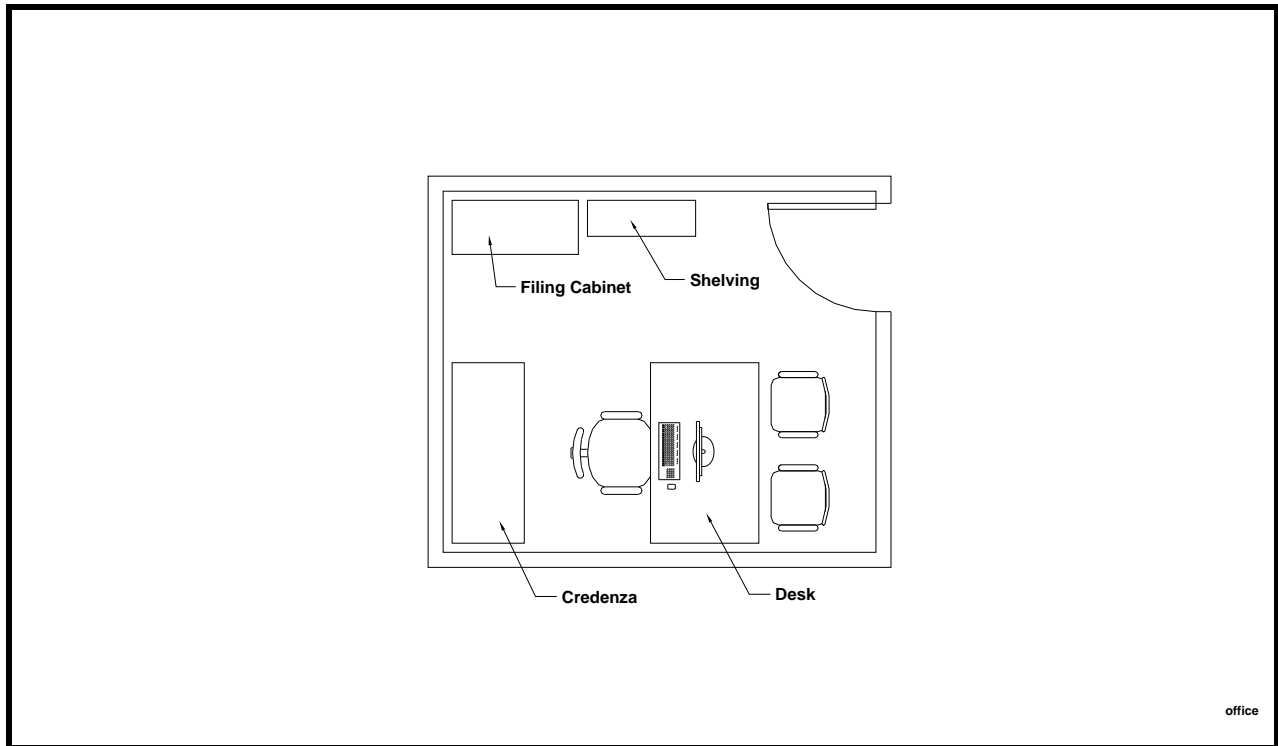

### Function

- Enclosed private office for the Maintenance Manager.

### Relationship to Other Areas

- Near General Repair Bays.
- Adjacent to other maintenance offices.

### Comments/Characteristics

- Furnishings: Desk, chair, shelving, file drawer, phone, computer, and printer.
- Utility Requirements: Grounded electrical convenience outlets, telephone, intercom/paging system, conduit for network computer system, air conditioned, and heated.
- Floor Finishes: Carpet.
- Wall Finishes: Painted gypsum board.
- Ceiling Finishes: Acoustical tile ceiling.
- Lighting: Office light fixture. Refer to chapter 4 for foot candle and fixture requirements.

# FUNCTIONAL REQUIREMENTS

Assistant Maintenance Manager

(Maintenance – Office/Support)

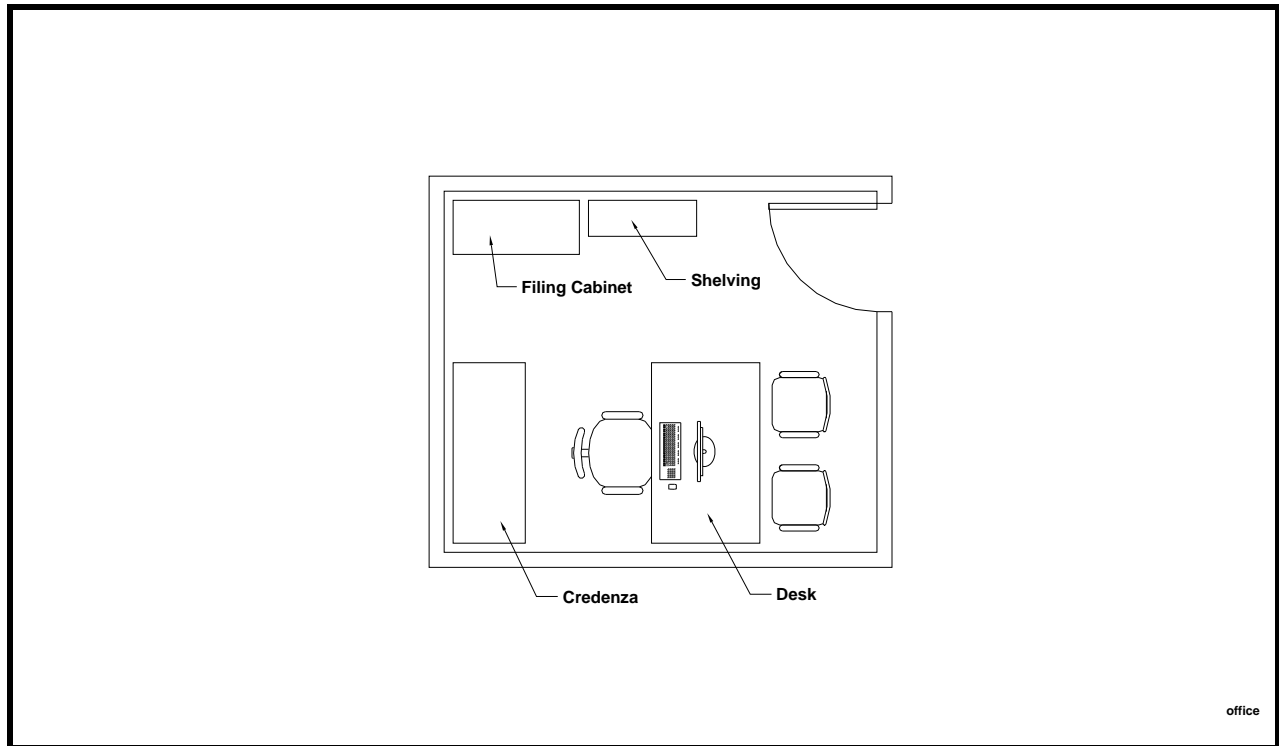

## Function

- Enclosed private office for the Assistant Maintenance Manager.

## Relationship to Other Areas

- Near General Repair Bays.
- Adjacent to Maintenance Manager.

## Comments/Characteristics

- Furnishings: Desk, chair, shelving, file drawer, phone, computer, and printer.
- Utility Requirements: Grounded electrical convenience outlets, telephone, intercom/paging system, conduit for network computer system, air conditioned, and heated.
- Floor Finishes: Carpet.
- Wall Finishes: Painted gypsum board.
- Ceiling Finishes: Acoustical tile ceiling.
- Lighting: Office light fixture. Refer to chapter 4 for foot candle and fixture requirements.

# FUNCTIONAL REQUIREMENTS

## Maintenance Supervisor

(Maintenance – Office/Support)

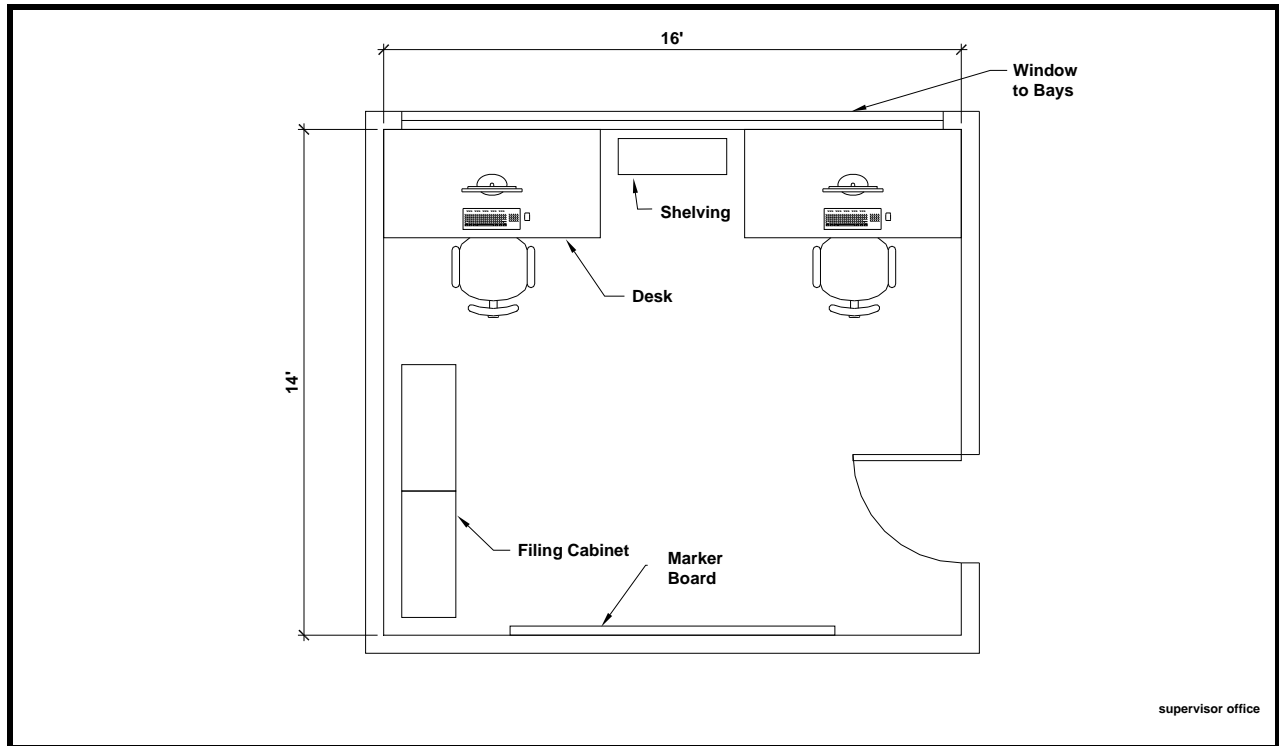

### Function

- Enclosed private office for both Maintenance Supervisors.

### Relationship to Other Areas

- Adjacent to General Repair Bays with view of bays.

### Comments/Characteristics

- Furnishings: Two desks, two chairs, marker board, shelving, file drawer, two phones, two computers, and printer.
- Utility Requirements: Grounded electrical convenience outlets, telephone, intercom/paging system, conduit for network computer system, air conditioned, and heated.
- Floor Finishes: Resilient flooring.
- Wall Finishes: Painted gypsum board.
- Ceiling Finishes: Acoustical tile ceiling.
- Lighting: Office light fixture. Refer to chapter 4 for foot candle and fixture requirements.

# FUNCTIONAL REQUIREMENTS

Administrative Assistant

(Maintenance – Office/Support)

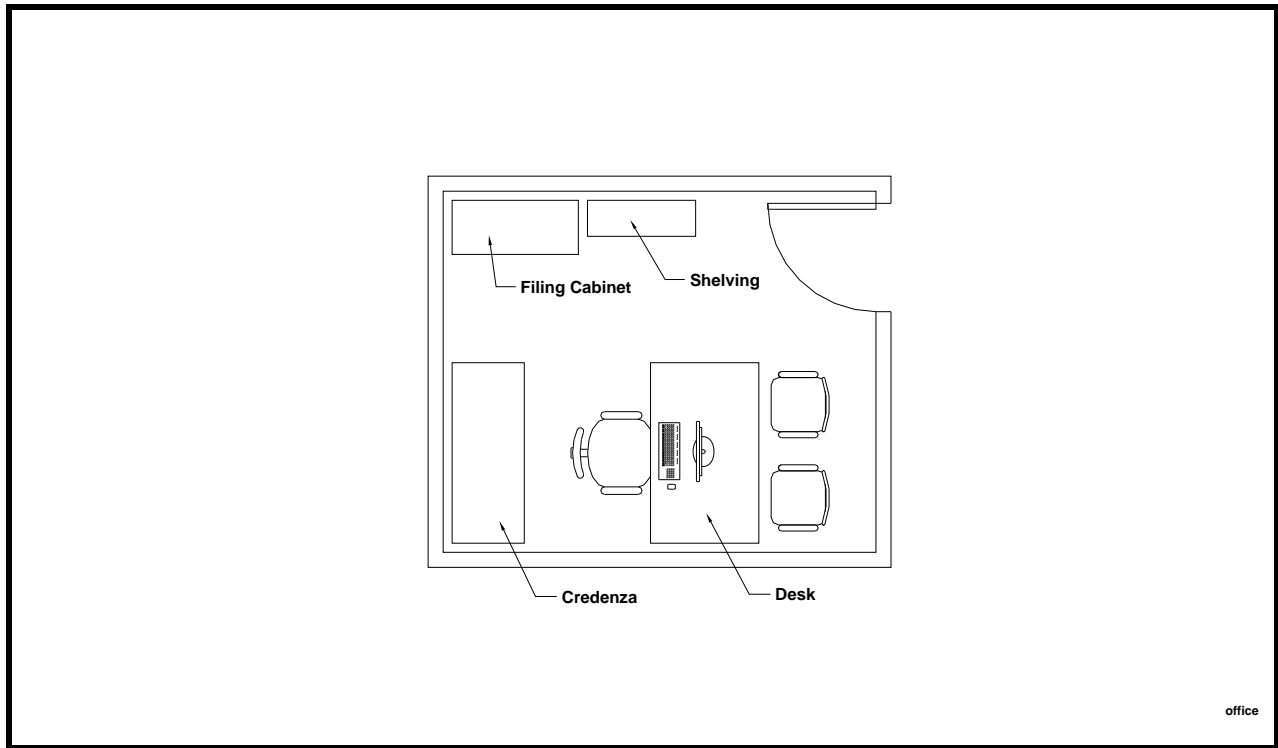

## Function

- Enclosed private office for the Administrative Assistant.

## Relationship to Other Areas

- Adjacent to Maintenance Manager.

## Comments/Characteristics

- Furnishings: Desk, chair, shelving, file drawer, phone, computer, and printer.
- Utility Requirements: Grounded electrical convenience outlets, telephone, intercom/paging system, conduit for network computer system, air conditioned, and heated.
- Floor Finishes: Carpet.
- Wall Finishes: Painted gypsum board.
- Ceiling Finishes: Acoustical tile ceiling.
- Lighting: Office light fixture. Refer to chapter 4 for foot candle and fixture requirements.

# FUNCTIONAL REQUIREMENTS

## Copier / Print Room

(Maintenance – Office/Support)

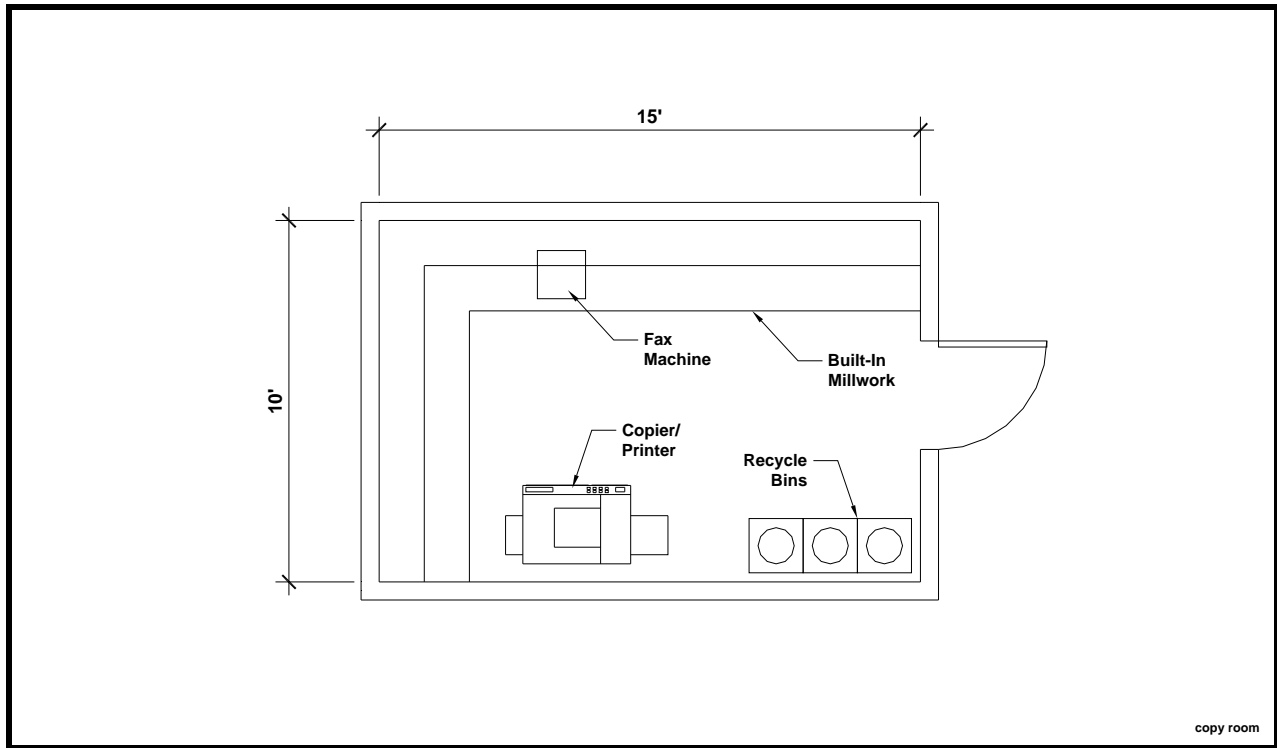

### Function

- Designated area for multi function copier/scanner/printer, fax, cutting board, supply storage, and work surfaces.

### Relationship to Other Areas

- Convenient to Maintenance staff.

### Comments/Characteristics

- Furnishings: 10 LF of counter work surface, 40 LF of shelving, 50 LF of lockable storage, multi function copier with sorter, paper cutter, cutting board, office supplies, phone, fax, laser printer, recycle bin, and possible layout table.
- Desk, chair, shelving, file drawer, phone, computer, and printer.
- Utility Requirements: Grounded electrical convenience outlets, telephone, intercom/paging system, conduit for network computer system, air conditioned, and heated.
- Floor Finishes: Carpet.
- Wall Finishes: Painted gypsum board.
- Ceiling Finishes: Acoustical tile ceiling.
- Lighting: Office light fixture. Refer to chapter 4 for foot candle and fixture requirements.

# FUNCTIONAL REQUIREMENTS

## Maintenance Lunch Room

(Maintenance – Office/Support)

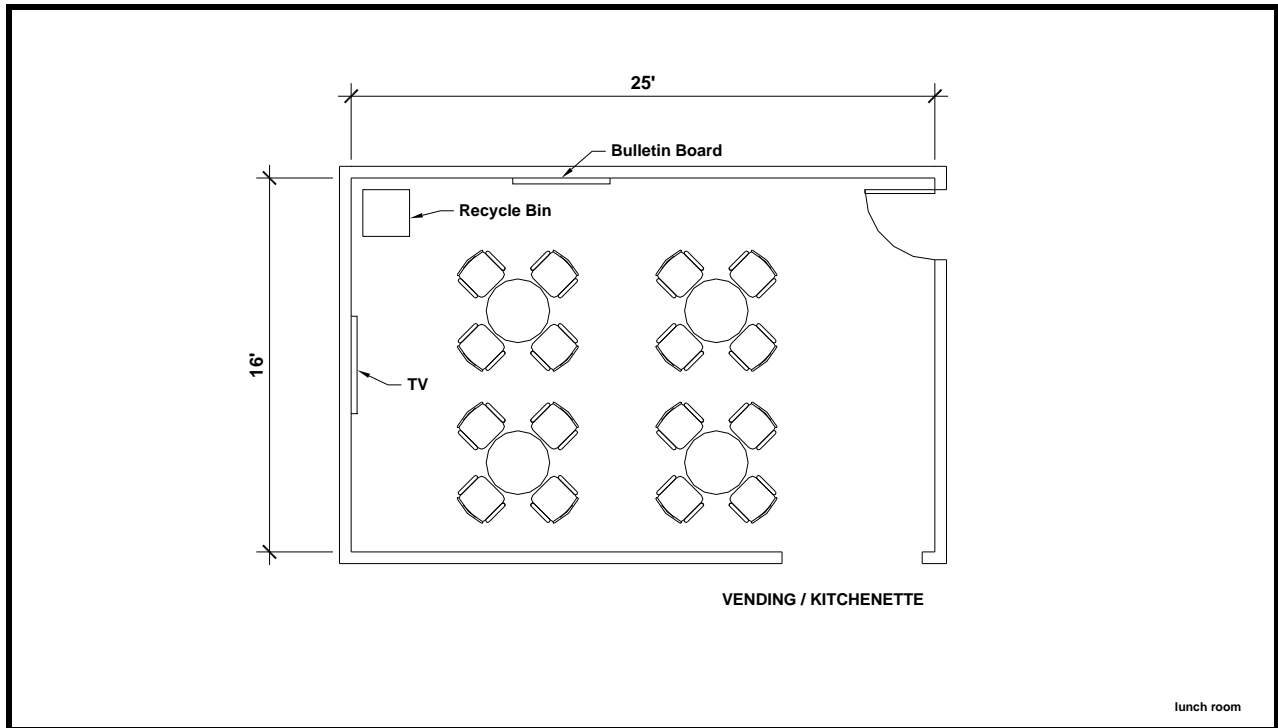

### Function

- Enclosed area for maintenance staff to eat meals.

### Relationship to Other Areas

- Adjacent to Vending/Kitchenette
- Convenient to Maintenance Bays.

### Comments/Characteristics

- Furnishings: Tables and chairs for 16 people, wall mounted television, bulletin board, and recycle bin.
- Utility Requirements: Grounded electrical convenience outlets, telephone, intercom/paging system, air conditioned, and heated, water, drain.
- Floor Finishes: Resilient flooring.
- Wall Finishes: Painted gypsum board.
- Ceiling Finishes: Acoustical tile ceiling.
- Lighting: Fluorescent. Refer to chapter 4 for foot candle requirements.



# FUNCTIONAL REQUIREMENTS

## Vending / Kitchenette

(Maintenance – Office/Support)

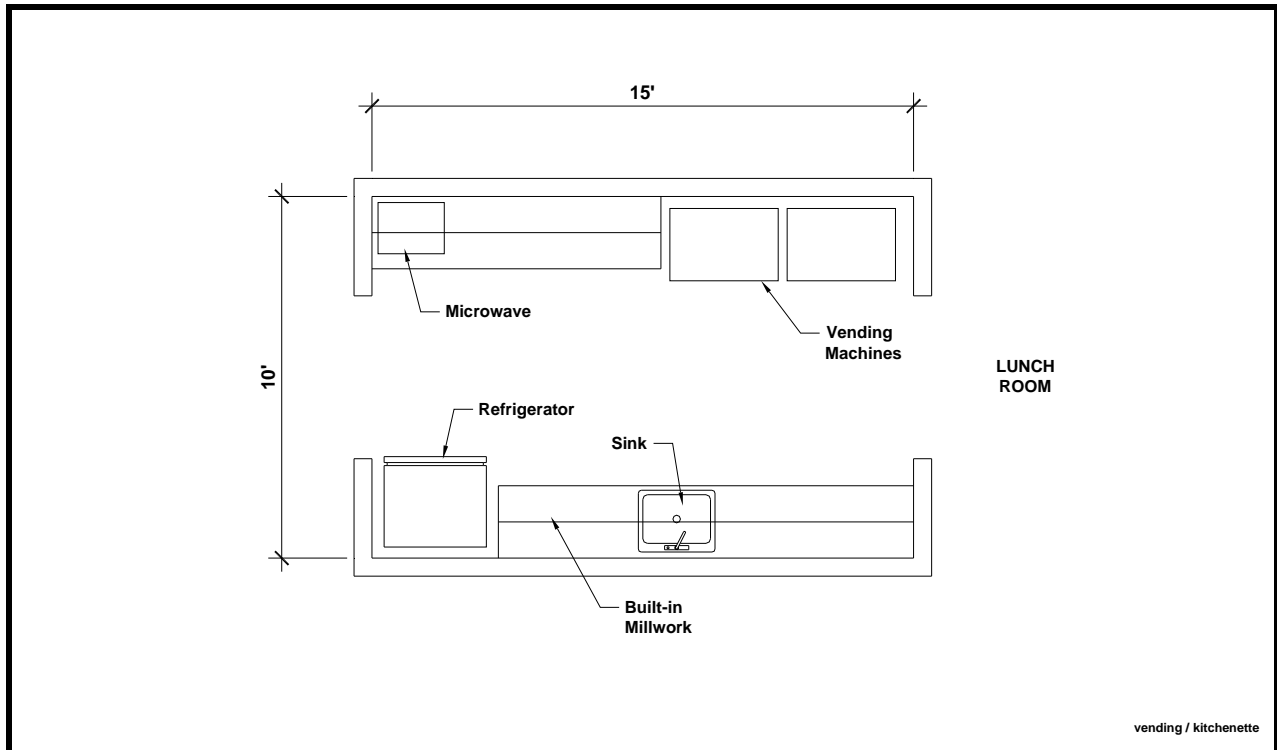

### Function

- Alcove area to house vending machines and food preparation equipment.

### Relationship to Other Areas

- Adjacent to Maintenance Lunch Room

### Comments/Characteristics

- Furnishings: Microwave, refrigerator, vending machine, and sink.
- Utility Requirements: Grounded electrical convenience outlets, telephone, intercom/paging system, air conditioned, and heated, floor drain near vending machine, water, drain.
- Floor Finishes: Resilient flooring.
- Wall Finishes: Painted gypsum board.
- Ceiling Finishes: Acoustical tile ceiling.
- Lighting: Fluorescent. Refer to chapter 4 for foot candle requirements.

# FUNCTIONAL REQUIREMENTS

## Training Room

(Maintenance – Office/Support)

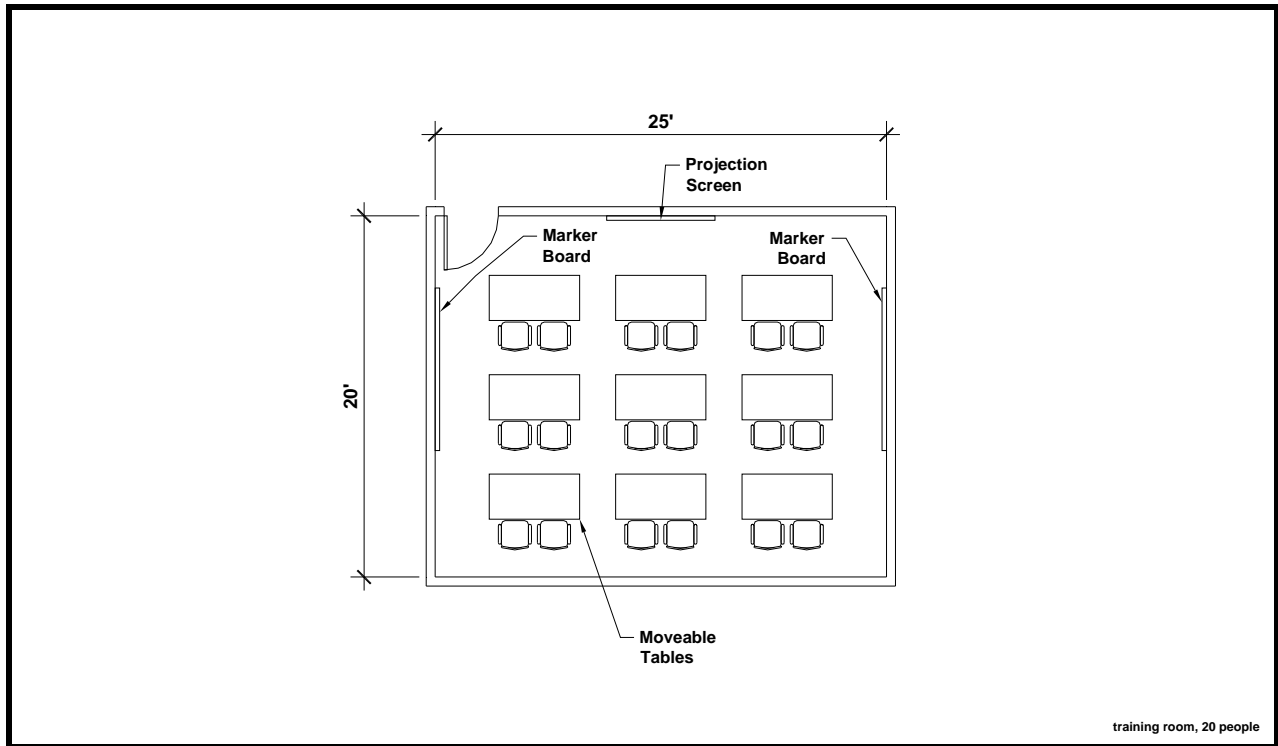

### Function

- Enclosed area for training sessions, comfortably accommodating up to 20 people with movable partition.

### Relationship to Other Areas

- Adjacent to Vending/Kitchenette.

### Comments/Characteristics

- Furnishings: Trainer desk with chair with hookup connections to digital projector, table & chair for up to 20 people, digital projector, pull-down projection screen, and marker board.
- Utility Requirements: Grounded electrical convenience outlets, telephone, intercom/paging system, air conditioned, and heated, conduit for network computer system
- Floor Finishes: Resilient flooring.
- Wall Finishes: Painted gypsum board.
- Ceiling Finishes: Acoustical tile ceiling.
- Lighting: Fluorescent. Refer to chapter 4 for foot candle requirements.
- Acoustically separated from surrounding spaces.

# FUNCTIONAL REQUIREMENTS

---

## **Women's Restroom / Locker / Shower**

**(Maintenance – Office/Support)**

### Function

- Restroom, shower, and locker facilities for female maintenance employees.

### Relationship to Other Areas

- Convenient to Repair Bays.

### Comments/Characteristics

- **Furnishings:** Provide toilet, stainless steel through type wash sink with gooseneck fixtures, shower stall, locker bench, 5 half lockers, both paper towel dispenser and air hand dryer, auto sensing faucet, paper towel and air hand dryer, auto sensing soap dispenser, auto flushing water closet, and other fixtures as required by code.
- **Utility Requirements:** Grounded electrical convenience outlets, telephone, intercom/paging system, air conditioned, and heated, water, drain.
- **Floor Finishes:** Epoxy coated concrete or porcelain tile.
- **Wall Finishes:** Epoxy paint or porcelain tile on gypsum board and/or concrete block.
- **Ceiling Finishes:** Painted gypsum board and acoustical tile ceiling where appropriate.
- **Lighting:** Fluorescent. Refer to chapter 4 for foot candle requirements.

## **Men's Restroom / Locker / Shower**

**(Maintenance – Office/Support)**

### Function

- Restroom, shower, and locker facilities for male maintenance employees.

### Relationship to Other Areas

- Convenient to Repair Bays.

### Comments/Characteristics

- **Furnishings:** Provide toilet, urinal, stainless steel through type wash sink with gooseneck fixture, shower stall, locker bench, 20 half lockers, both paper towel dispenser and air hand dryer, auto sensing faucet, paper towel and air hand dryer, auto sensing soap dispenser, flushing urinal and water closet, and other fixtures as required by code.
- **Utility Requirements:** Grounded electrical convenience outlets, telephone, intercom/paging system, air conditioned, and heated, water, drain.
- **Floor Finishes:** Epoxy coated concrete or porcelain tile.
- **Wall Finishes:** Epoxy paint or porcelain tile on gypsum board and/or concrete block.
- **Ceiling Finishes:** Painted gypsum board and acoustical tile ceiling where appropriate.
- **Lighting:** Fluorescent. Refer to chapter 4 for foot candle requirements.

# FUNCTIONAL REQUIREMENTS

---

## **Laundry Room - Clean**

*(Maintenance – Office/Support)*

### Function

- Alcove for storage of clean uniforms.

### Relationship to Other Areas

- Adjacent to Locker Rooms.

### Comments/Characteristics

- Furnishings: Uniform racks.
- Utility Requirements: Grounded electrical convenience outlets, ventilated, and heated.
- Floor Finishes: Sealed concrete.
- Wall Finishes: Painted gypsum board.
- Ceiling Finishes: Acoustical tile ceiling or painted exposed structure.
- Lighting: Fluorescent. Refer to chapter 4 for foot candle requirements.

## **Laundry Room - Dirty**

*(Maintenance – Office/Support)*

### Function

- Alcove for storage of dirty uniforms.

### Relationship to Other Areas

- Adjacent to Locker Rooms.

### Comments/Characteristics

- Furnishings: Laundry baskets.
- Utility Requirements: Grounded electrical convenience outlets, ventilated, and heated.
- Floor Finishes: Sealed concrete.
- Wall Finishes: Painted gypsum board.
- Ceiling Finishes: Acoustical tile ceiling or painted exposed structure.
- Lighting: Fluorescent. Refer to chapter 4 for foot candle requirements.

---

# FUNCTIONAL REQUIREMENTS

---

## **Custodial Room**

*(Maintenance – Office/Support)*

### Function

- Enclosed area for storage of janitorial supplies and cleaning equipment.

### Relationship to Other Areas

- Conveniently located near General Repair Bays and maintenance office / support areas.

### Comments/Characteristics

- Furnishings: Shelving unit floor sink.
- Utility Requirements: Grounded electrical convenience outlets, ventilated, and heated.
- Floor Finishes: Sealed concrete.
- Wall Finishes: Painted gypsum board.
- Ceiling Finishes: Acoustical tile ceiling or painted exposed structure.
- Lighting: Fluorescent. Refer to chapter 4 for foot candle requirements.

## **IT / Telecommunications Room**

*(Maintenance – Office/Support)*

### Function

- Enclosed, secure room for telephone and computer networking equipment.

### Relationship to Other Areas

- Centrally located in the facility.

### Comments/Characteristics

- Furnishings: Uninterrupted power supply (UPS), network server racks, 4' x 8' painted plywood punch down block support panels on wall.
- Utility Requirements: Grounded electrical convenience outlets, telephone, intercom/paging system, conduit for network computer system, air conditioned (separately controlled unit), and heated. All electrical to be on dedicated circuits.
- Floor Finishes: Sealed concrete.
- Wall Finishes: Painted gypsum board and/or concrete block.
- Ceiling Finishes: Painted exposed structure.
- Lighting: High bay Fluorescent. Refer to Chapter 4 for foot candle lighting requirements.
- Provide good airflow to dissipate heat generated by equipment.
- Double door to accommodate equipment.
- Room must be secure (including ceiling) from other areas.
- Electrical must be backed up with UPS emergency generator power.
- Size will be determined during design.

# FUNCTIONAL REQUIREMENTS

---

## **Mechanical Room**

*(Maintenance – Office/Support)*

### Function

- Designated space for mechanical building support equipment.

### Relationship to Other Areas

- Centrally located in the facility.

### Comments/Characteristics

- Furnishings: Mechanical equipment as required.
- Utility requirements: Grounded electrical convenience outlets, ventilated, and heated.
- Floor Finishes: Exposed concrete.
- Wall Finishes: Painted gypsum board and/or concrete block.
- Ceiling Finishes: Exposed structure.
- Lighting: High bay Fluorescent. Refer to Chapter 4 for foot candle lighting requirements.
- Size will be determined during design.

## **Electrical Room**

*(Maintenance – Office/Support)*

### Function

- Designated space for electrical building support equipment.

### Relationship to Other Areas

- Centrally located in the facility.

### Comments/Characteristics

- Furnishings: Electrical equipment as required.
- Utility requirements: Grounded electrical convenience outlets, ventilated, and heated.
- Floor Finishes: Exposed concrete.
- Wall Finishes: Painted gypsum board and/or concrete block.
- Ceiling Finishes: Exposed structure.
- Lighting: High bay Fluorescent. Refer to Chapter 4 for foot candle lighting requirements.
- Size will be determined during design.

# FUNCTIONAL REQUIREMENTS

---

## **Fire Riser Room**

*(Maintenance – Office/Support)*

### Function

- Designated space for fire riser equipment.

### Relationship to Other Areas

- Centrally located.

### Comments/Characteristics

- Furnishings: Fire riser equipment as required.
- Utility requirements: Grounded electrical convenience outlets, ventilated, and heated.
- Floor Finishes: Exposed concrete.
- Wall Finishes: Painted gypsum board and/or concrete block.
- Ceiling Finishes: Exposed structure.
- Lighting: High bay Fluorescent. Refer to Chapter 4 for foot candle lighting requirements.
- Size will be determined during design.

# FUNCTIONAL REQUIREMENTS

---

THIS PAGE LEFT INTENTIONALLY BLANK



# FUNCTIONAL REQUIREMENTS

## MAINTENANCE – BAYS & SHOPS

### FUNCTIONAL RELATIONSHIPS

The relationships between the various functional areas within this section are shown below. The design should accommodate these relationships in order to maximize operational efficiency. This diagram is not meant to be a floor plan, only a representational relationship diagram.

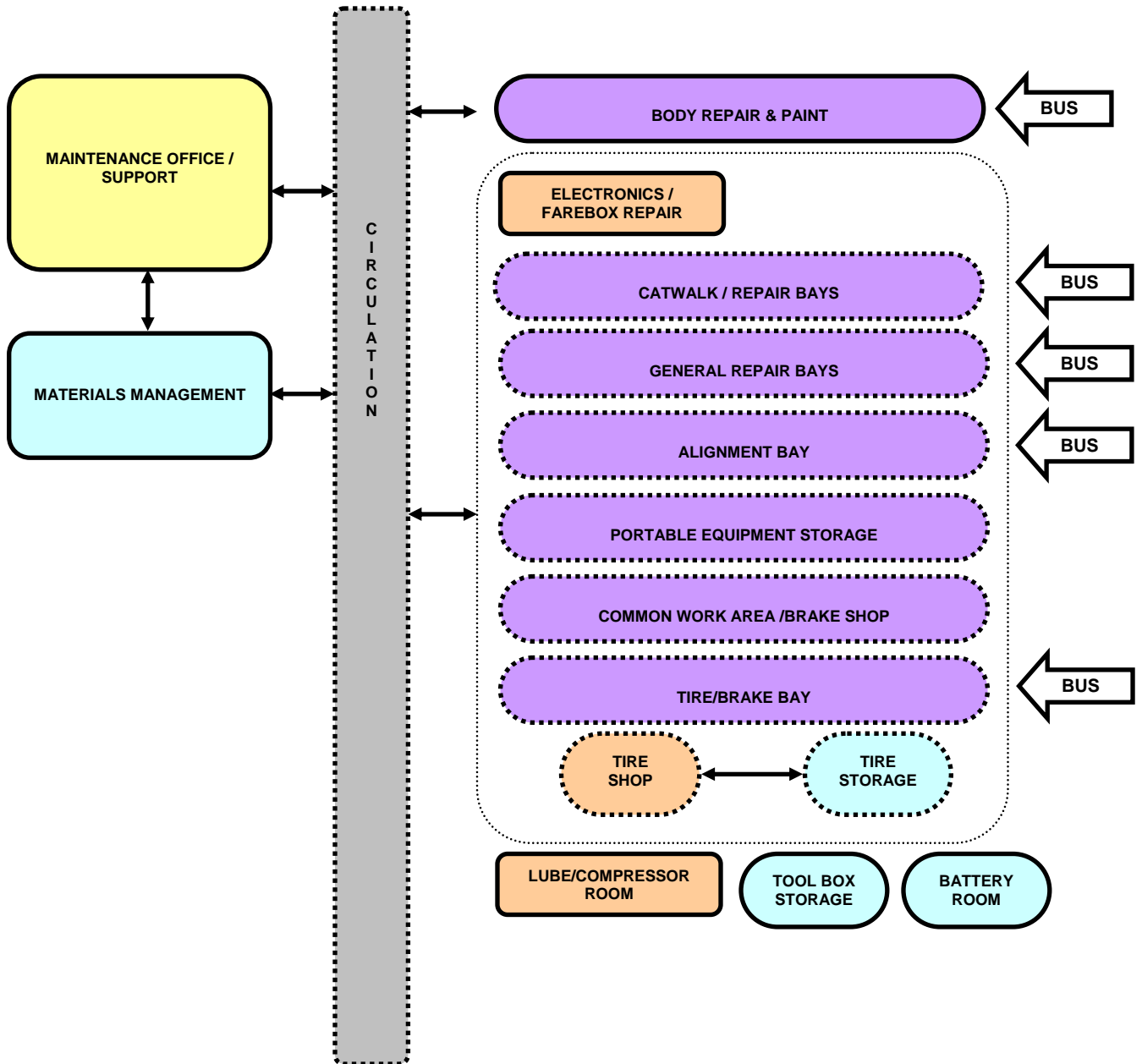

### FUNCTIONAL AREA MODULES

Each functional area within this section has been individually defined as a module. Each module has information regarding the function of the space, relationships to other areas, critical dimensions (if any), equipment/furnishings, and finishes. Technical considerations for ventilation, mechanical, plumbing, and electrical are also defined. The Equipment List takes precedence over equipment shown in modules.

# FUNCTIONAL REQUIREMENTS

## General Repair Bays (Standard Buses)

(Maintenance – Bays & Shops)

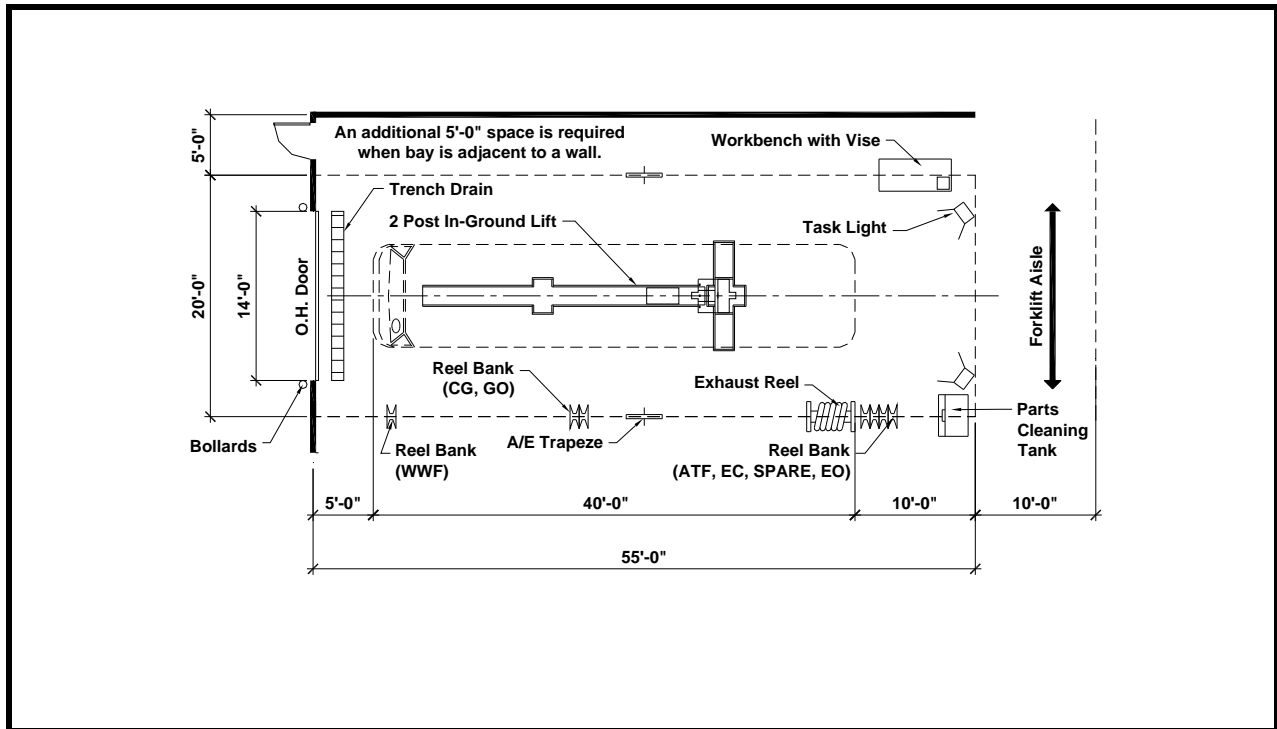

### Function

- Designated maintenance bay for general repairs for 40 foot buses.

### Relationship to Other Areas

- Near Common Work Area, Equipment Storage, Tool Crib.

### Critical Dimensions

- 19'-0" vertical clearance.
- 20'-0" wide by 55'-0" long.

### Equipment/Furnishings

- Severe use workbench w/ vise, parts cleaning tank, in-ground vehicle lift, overhead reel bank, and 6" overhead vehicle exhaust reel, fall protection monorail, suspended bridge crane, air/electric trapeze.

### Comments

- Forklift access.

# FUNCTIONAL REQUIREMENTS

---

## TECHNICAL CONSIDERATIONS

### Architectural

- Finishes
  - Floor: Soil, grease, and water resistant concrete, with integral non-metallic hardener, and clear epoxy sealer. Provide slip resistant finish.
  - Walls: Soil and grease resistant. Epoxy painted to 8 feet AFF.
  - Ceiling: Painted exposed structure.
- Doors
  - Personnel doors to meet applicable codes and exiting requirements.
  - Exterior overhead door: 14' x 14' motor operated with interior push button controls, and lockout on exterior.
- Bollards on exterior at jambs of overhead door (2 per door).

### Structural

- Control joints in floor slab at adequate spacing.
- Structural columns must not be located at the sides between bays.
- Structure as needed to support equipment.

### Mechanical

- Overhead vehicle exhaust system with 6" exhaust hose on a motorized reel with integral exhaust fan and automatic fan switch at rear of vehicle position.
- Heating system must be compatible with use of alternative fueled vehicles.
- Ventilation as required by codes to prevent accumulation of explosive mixtures.
- General ventilation as required by codes.
- As required by equipment.

### Plumbing

- Trench drain just inside overhead doors (with removable cover) to oil/water separator.
- Overhead lube reel banks.
- 3/4" water hose bib with standard faucet at 4'-0" AFF between bay doors (1 per 3 bays).
- Compressed air line with cut-off valve, filter, regulator with gauge, lubricator, and quick disconnects at 4'-0" AFF between bay doors. Provide disconnects for 1/2 and 1 inch impact tools at locations to be determined during detailed design.
- As required by equipment.

### Electrical

- Lighting
  - Maximize Day-Lighting
  - High bay fixture. Refer to chapter 4 for foot candle lighting requirements.
  - Individually switched Task Lighting at engine end of vehicle.
- Power
  - Special purpose outlet, centrally located, 208VAC, 1ph, 50A at 3'-6" AFF (1 per 4 bays).
  - General purpose duplex receptacles, 120VAC, 20A, GFI protected on walls, columns, and between overhead doors at 3'-6" AFF.
  - As required by equipment.
- Communications
  - Paging/intercom system speakers.
  - Data port in each repair bay.

# FUNCTIONAL REQUIREMENTS

## General Repair Bays (Articulated Buses)

(Maintenance – Bays & Shops)

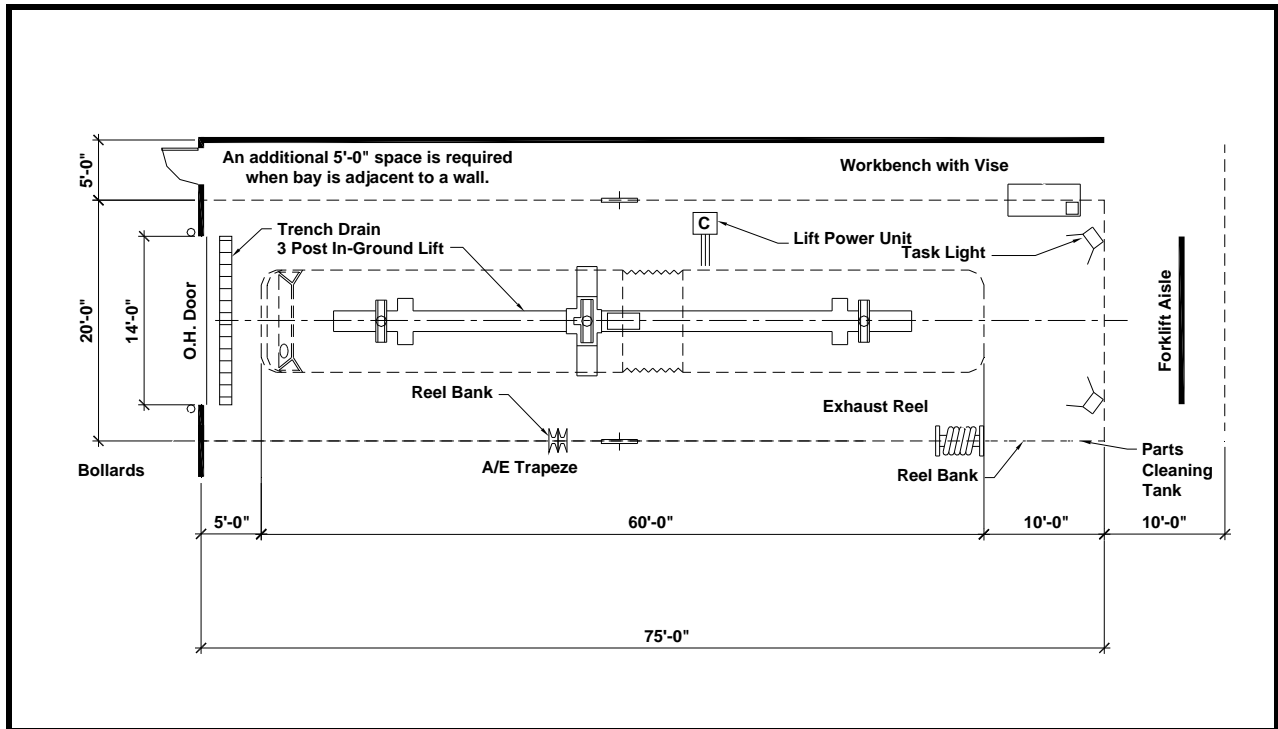

### Function

- Designated maintenance bay for general repairs for articulated buses.

### Relationship to Other Areas

- Near Common Work Area, Equipment Storage, Tool Crib.

### Critical Dimensions

- 19'-0" vertical clearance.
- 20'-0" wide by 75'-0" long.

### Equipment/Furnishings

- Severe use workbench w/ vise, parts cleaning tank, in-ground vehicle lift, overhead reel bank, and 6" overhead vehicle exhaust reel, fall protection monorail, air/electric trapeze.

### Comments

- Forklift access.

# FUNCTIONAL REQUIREMENTS

---

## TECHNICAL CONSIDERATIONS

### Architectural

- Finishes
  - Floor: Soil, grease, and water resistant concrete, with integral non-metallic hardener, and clear epoxy sealer. Provide slip resistant finish.
  - Walls: Soil and grease resistant. Epoxy painted to 8 feet AFF.
  - Ceiling: Painted exposed structure.
- Doors
  - Personnel doors to meet applicable codes and exiting requirements.
  - Exterior overhead door: 14' x 14' motor operated with interior push button controls, and lockout on exterior.
- Bollards on exterior at jambs of overhead door (2 per door).

### Structural

- Control joints in floor slab at adequate spacing.
- Structural columns must not be located at the sides between bays.
- Structure as needed to support equipment.

### Mechanical

- Overhead vehicle exhaust system with 6" exhaust hose on a motorized reel with integral exhaust fan and automatic fan switch at rear of vehicle position.
- Heating system must be compatible with use of alternative fueled vehicles.
- Ventilation as required by codes to prevent accumulation of explosive mixtures.
- General ventilation as required by codes.
- As required by equipment.

### Plumbing

- Trench drain just inside overhead doors (with removable cover) to oil/water separator.
- Overhead lube reel banks.
- 3/4" water hose bib with standard faucet at 4'-0" AFF between bay doors (1 per 3 bays).
- Compressed air line with cut-off valve, filter, regulator with gauge, lubricator, and quick disconnects at 4'-0" AFF between bay doors. Provide disconnects for 1/2 and 1 inch impact tools at locations to be determined during detailed design.
- As required by equipment.

### Electrical

- Lighting
  - Maximize Day-Lighting
  - High bay fixture. Refer to chapter 4 for foot candle lighting requirements.
  - Individually switched Task Lighting at engine end of vehicle.
- Power
  - Special purpose outlet, centrally located, 208VAC, 1ph, 50A at 3'-6" AFF (1 per 4 bays).
  - General purpose duplex receptacles, 120VAC, 20A, GFI protected on walls, columns, and between overhead doors at 3'-6" AFF.
  - As required by equipment.
- Communications
  - Paging/intercom system speakers.
  - Data port in each repair bay.

# FUNCTIONAL REQUIREMENTS

## General Repair Bays (Paratransit / NRV)

(Maintenance – Bays & Shops)

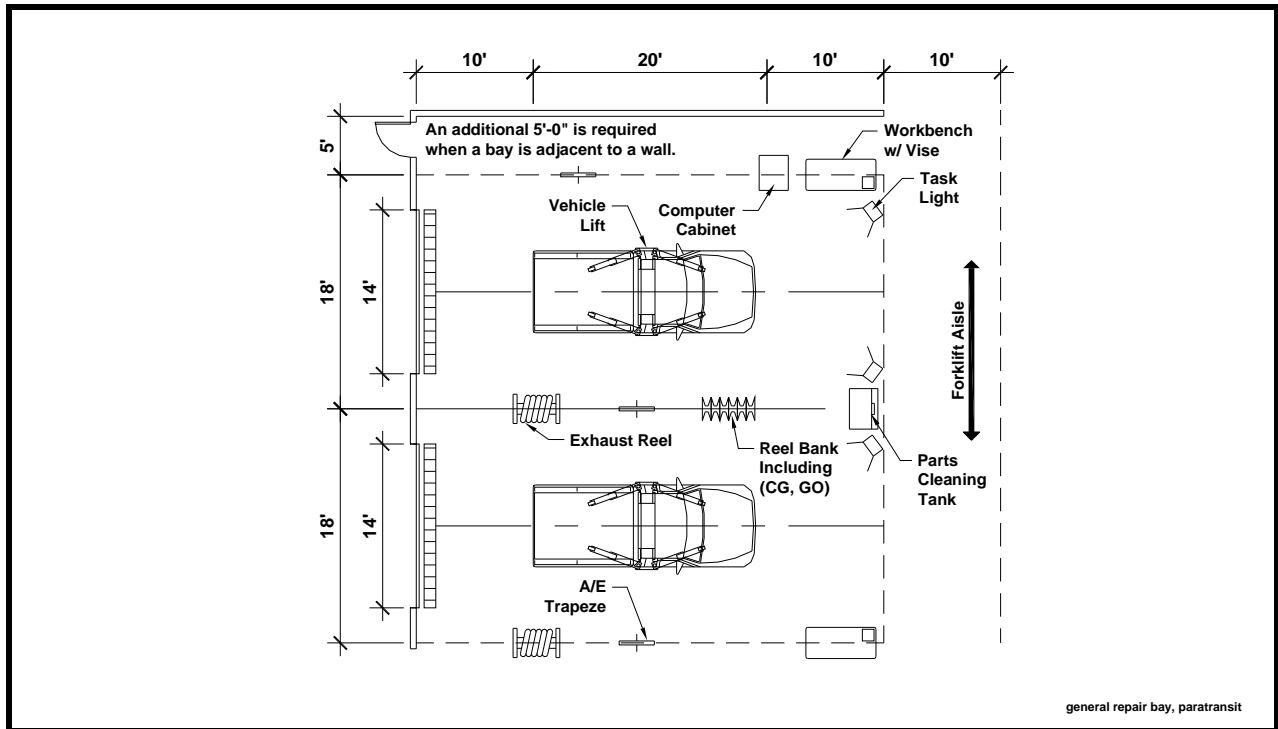

### Function

- Designated maintenance bay for general repairs for paratransit and non-revenue vehicles.

### Relationship to Other Areas

- Near Common Work Area, Equipment Storage, Tool Crib.

### Critical Dimensions

- 19'-0" vertical clearance.
- 18'-0" wide by 40'-0" long.

### Equipment/Furnishings

- Severe use workbench w/ vise, parts cleaning tank, in-ground vehicle lift, overhead reel bank, and 6" overhead vehicle exhaust reel, air/electric trapeze.

### Comments

- Forklift access.

# FUNCTIONAL REQUIREMENTS

---

## TECHNICAL CONSIDERATIONS

### Architectural

- Finishes
  - Floor: Soil, grease, and water resistant concrete, with integral non-metallic hardener, and clear epoxy sealer. Provide slip resistant finish.
  - Walls: Soil and grease resistant. Epoxy painted to 8 feet AFF.
  - Ceiling: Painted exposed structure.
- Doors
  - Personnel doors to meet applicable codes and exiting requirements.
  - Exterior overhead door: 14' x 14' motor operated with interior push button controls, and lockout on exterior.
- Bollards on exterior at jambs of overhead door (2 per door).

### Structural

- Control joints in floor slab at adequate spacing.
- Structural columns must not be located at the sides between bays.
- Structure as needed to support equipment.

### Mechanical

- Overhead vehicle exhaust system with 6" exhaust hose on a motorized reel with integral exhaust fan and automatic fan switch at rear of vehicle position.
- Heating system must be compatible with use of alternative fueled vehicles.
- Ventilation as required by codes to prevent accumulation of explosive mixtures.
- General ventilation as required by codes.
- As required by equipment.

### Plumbing

- Trench drain just inside overhead doors (with removable cover) to oil/water separator.
- Overhead lube reel banks.
- 3/4" water hose bib with standard faucet at 4'-0" AFF between bay doors (1 per 3 bays).
- Compressed air line with cut-off valve, filter, regulator with gauge, lubricator, and quick disconnects at 4'-0" AFF between bay doors. Provide disconnects for 1/2 and 1 inch impact tools at locations to be determined during detailed design.
- As required by equipment.

### Electrical

- Lighting
  - Maximize Day-Lighting
  - High bay fixture. Refer to chapter 4 for foot candle lighting requirements.
  - Individually switched Task Lighting at engine end of vehicle.
- Power
  - Special purpose outlet, centrally located, 208VAC, 1ph, 50A at 3'-6" AFF (1 per 4 bays).
  - General purpose duplex receptacles, 120VAC, 20A, GFI protected on walls, columns, and between overhead doors at 3'-6" AFF.
  - As required by equipment.
- Communications
  - Paging/intercom system speakers.
  - Data port in each repair bay.

# FUNCTIONAL REQUIREMENTS

## Alignment Bay

(Maintenance – Bays & Shops)

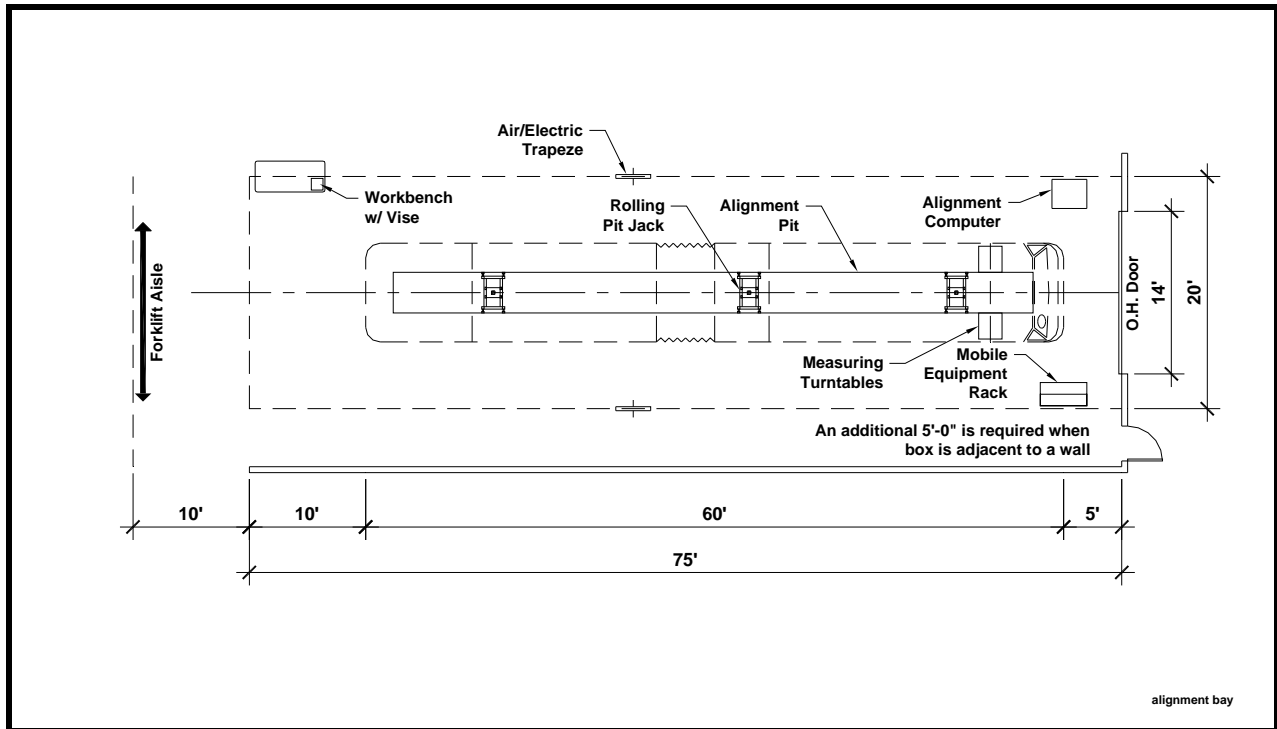

### Function

- Designated bay for wheel alignments of standard and articulated buses.

### Relationship to Other Areas

- Adjacent to HVAC and Final Inspection.

### Critical Dimensions

- 19'-0" vertical clearance.
- 20'-0" wide by 75'-0" long (articulated).
- 20'-0" wide by 55'-0" long (standard).

### Equipment/Furnishings

- Full alignment rack with pit.

### Comments

- Forklift access.



# FUNCTIONAL REQUIREMENTS

---

## TECHNICAL CONSIDERATIONS

### Architectural

- Finishes
  - Floor: Soil, grease, and water resistant concrete, with integral non-metallic hardener, and clear epoxy sealer. Provide slip resistant finish.
  - Walls: Soil and grease resistant. Epoxy painted to 8' AFF.
  - Ceiling: Painted exposed structure.
- Doors
  - Personnel doors to meet applicable codes and exiting requirements.
  - Exterior overhead door: 14' x 14' motor operated with interior push button controls, and lockout on exterior.
- Bollards on interior and exterior at jambs of overhead door (4 per door - total).

### Structural

- Control joints in floor slab at adequate spacing.
- Structural columns must not be located at the sides between bays.
- Structure as needed to support equipment (Including reel banks, overhead exhaust reel, air/electric trapeze, and fall protection).

### Mechanical

- Heating system must be compatible with use of CNG fueled vehicles.
- Ventilation as required by codes to prevent accumulation of explosive mixtures.
- General ventilation as required by codes.
- As required by equipment.

### Plumbing

- Trench drain just inside overhead doors.
- 3/4" water hose bib with standard faucet between bay doors at 4'-0" AFF (1 per 2 bays).
- Compressed air line with cut-off valve, filter, regulator with gauge, lubricator, cleanout valve, and quick disconnects at 4'-0" AFF (between bay doors) and on air/electric drop "trapeze" between bays at mid-bay (shared with adjacent bays). Provide disconnects for 1/2" and 1" impact tools at locations to be determined during detailed design.
- As required by equipment.

### Electrical

- Lighting
  - High bay fixture. Refer to chapter 4 for foot candle lighting requirements.
  - Individual switched task light at engine of vehicle.
- Power
  - Air/electric drop trapeze mounted quad receptacle, 120VAC, 20A, GFI protected between bays.
  - General purpose duplex receptacles, 120VAC, 20A, GFI protected, on walls, columns, and between overhead doors at 3'-6" AFF.
  - As required by equipment.
- Communications
  - Paging/intercom system speakers in bay.
  - Data port in each repair bay at columns and/or on air/electric trapeze at workbench locations in bay.
  - Wireless access in bay.
- Gas detection / alarm system for CNG fueled vehicles.

# FUNCTIONAL REQUIREMENTS

## Tire Bay (Standard Buses)

(Maintenance – Bays & Shops)

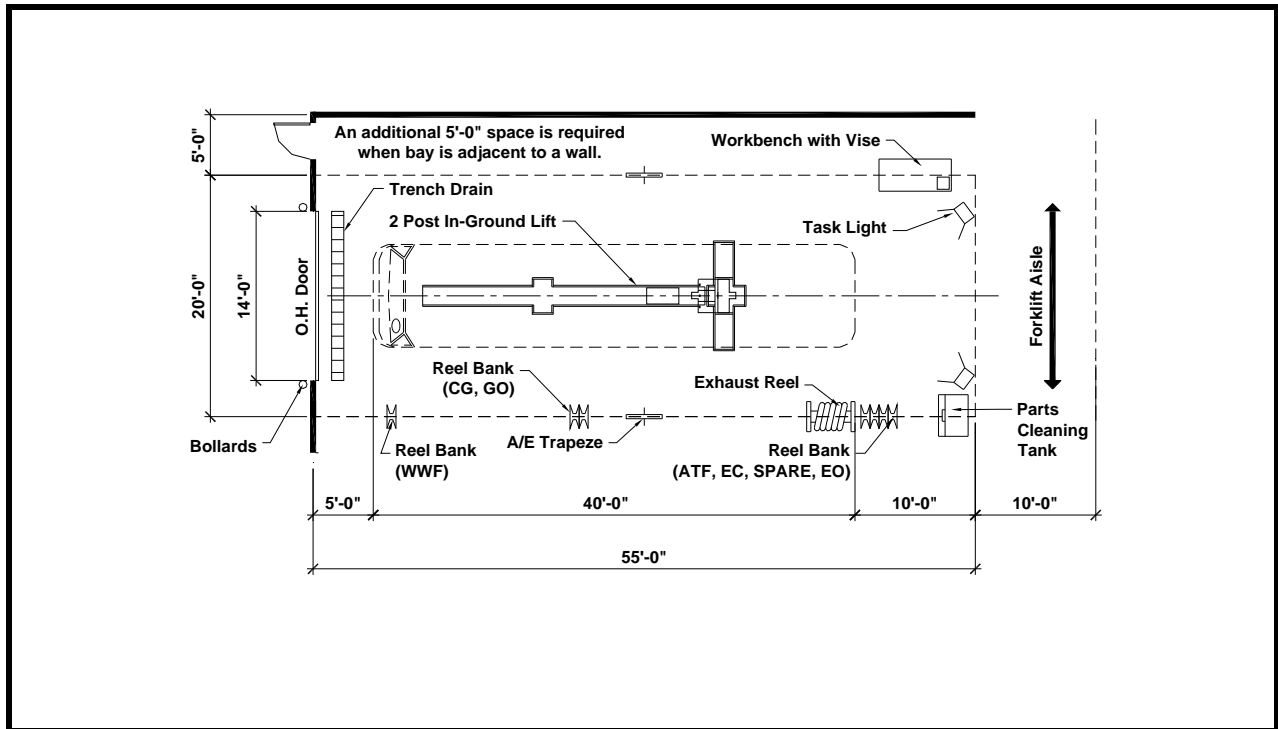

### Function

- Designated maintenance bay for tire repairs for 40 foot buses.

### Relationship to Other Areas

- Adjacent to Tire Shop and Tire Storage.

### Critical Dimensions

- 19'-0" vertical clearance.
- 20'-0" wide by 55'-0" long.

### Equipment/Furnishings

- Severe use workbench w/ vise, parts cleaning tank, in-ground vehicle lift, overhead reel bank, and 6" overhead vehicle exhaust reel, air/electric trapeze.

### Comments

- Forklift access.

# FUNCTIONAL REQUIREMENTS

---

## TECHNICAL CONSIDERATIONS

### Architectural

- Finishes
  - Floor: Soil, grease, and water resistant concrete, with integral non-metallic hardener, and clear epoxy sealer. Provide slip resistant finish.
  - Walls: Soil and grease resistant. Epoxy painted to 8 feet AFF.
  - Ceiling: Painted exposed structure.
- Doors
  - Personnel doors to meet applicable codes and exiting requirements.
  - Exterior overhead door: 14' x 14' motor operated with interior push button controls, and lockout on exterior.
- Bollards on exterior at jambs of overhead door (2 per door).

### Structural

- Control joints in floor slab at adequate spacing.
- Structural columns must not be located at the sides between bays.
- Structure as needed to support equipment.

### Mechanical

- Overhead vehicle exhaust system with 6" exhaust hose on a motorized reel with integral exhaust fan and automatic fan switch at rear of vehicle position.
- Heating system must be compatible with use of alternative fueled vehicles.
- Ventilation as required by codes to prevent accumulation of explosive mixtures.
- General ventilation as required by codes.
- As required by equipment.

### Plumbing

- Trench drain just inside overhead doors (with removable cover) to oil/water separator.
- Overhead lube reel banks.
- 3/4" water hose bib with standard faucet at 4'-0" AFF between bay doors (1 per 3 bays).
- Compressed air line with cut-off valve, filter, regulator with gauge, lubricator, and quick disconnects at 4'-0" AFF between bay doors. Provide disconnects for 1/2 and 1 inch impact tools at locations to be determined during detailed design.
- As required by equipment.

### Electrical

- Lighting
  - Maximize Day-Lighting
  - High bay fixture. Refer to chapter 4 for foot candle lighting requirements.
  - Individually switched Task Lighting at engine end of vehicle.
- Power
  - Special purpose outlet, centrally located, 208VAC, 1ph, 50A at 3'-6" AFF (1 per 4 bays).
  - General purpose duplex receptacles, 120VAC, 20A, GFI protected on walls, columns, and between overhead doors at 3'-6" AFF.
  - As required by equipment.
- Communications
  - Paging/intercom system speakers.
  - Data port in each repair bay.

# FUNCTIONAL REQUIREMENTS

## Tire Bay (Articulated Buses)

(Maintenance – Bays & Shops)

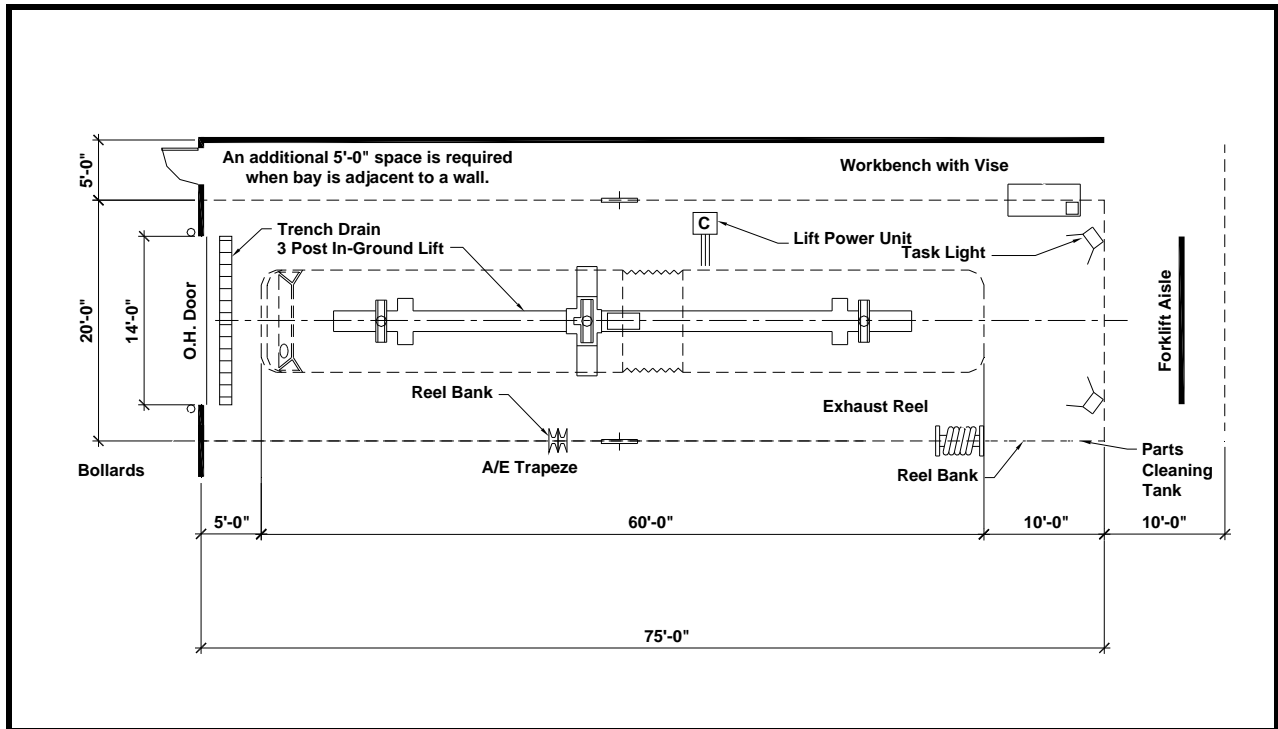

### Function

- Designated maintenance bay for tire repairs to articulated buses.

### Relationship to Other Areas

- Adjacent to Tire Shop and Tire Storage.

### Critical Dimensions

- 19'-0" vertical clearance.
- 20'-0" wide by 75'-0" long.

### Equipment/Furnishings

- Severe use workbench w/ vise, parts cleaning tank, in-ground vehicle lift, overhead reel bank, and 6" overhead vehicle exhaust reel, air/electric trapeze.

### Comments

- Forklift access.

# FUNCTIONAL REQUIREMENTS

---

## TECHNICAL CONSIDERATIONS

### Architectural

- Finishes
  - Floor: Soil, grease, and water resistant concrete, with integral non-metallic hardener, and clear epoxy sealer. Provide slip resistant finish.
  - Walls: Soil and grease resistant. Epoxy painted to 8 feet AFF.
  - Ceiling: Painted exposed structure.
- Doors
  - Personnel doors to meet applicable codes and exiting requirements.
  - Exterior overhead door: 14' x 14' motor operated with interior push button controls, and lockout on exterior.
- Bollards on exterior at jambs of overhead door (2 per door).

### Structural

- Control joints in floor slab at adequate spacing.
- Structural columns must not be located at the sides between bays.
- Structure as needed to support equipment.

### Mechanical

- Overhead vehicle exhaust system with 6" exhaust hose on a motorized reel with integral exhaust fan and automatic fan switch at rear of vehicle position.
- Heating system must be compatible with use of alternative fueled vehicles.
- Ventilation as required by codes to prevent accumulation of explosive mixtures.
- General ventilation as required by codes.
- As required by equipment.

### Plumbing

- Trench drain just inside overhead doors (with removable cover) to oil/water separator.
- Overhead lube reel banks.
- 3/4" water hose bib with standard faucet at 4'-0" AFF between bay doors (1 per 3 bays).
- Compressed air line with cut-off valve, filter, regulator with gauge, lubricator, and quick disconnects at 4'-0" AFF between bay doors. Provide disconnects for 1/2 and 1 inch impact tools at locations to be determined during detailed design.
- As required by equipment.

### Electrical

- Lighting
  - Maximize Day-Lighting
  - High bay fixture. Refer to chapter 4 for foot candle lighting requirements.
  - Individually switched Task Lighting at engine end of vehicle.
- Power
  - Special purpose outlet, centrally located, 208VAC, 1ph, 50A at 3'-6" AFF (1 per 4 bays).
  - General purpose duplex receptacles, 120VAC, 20A, GFI protected on walls, columns, and between overhead doors at 3'-6" AFF.
  - As required by equipment.
- Communications
  - Paging/intercom system speakers.
  - Data port in each repair bay.

# FUNCTIONAL REQUIREMENTS

## Tire Shop

(Maintenance – Bays & Shops)

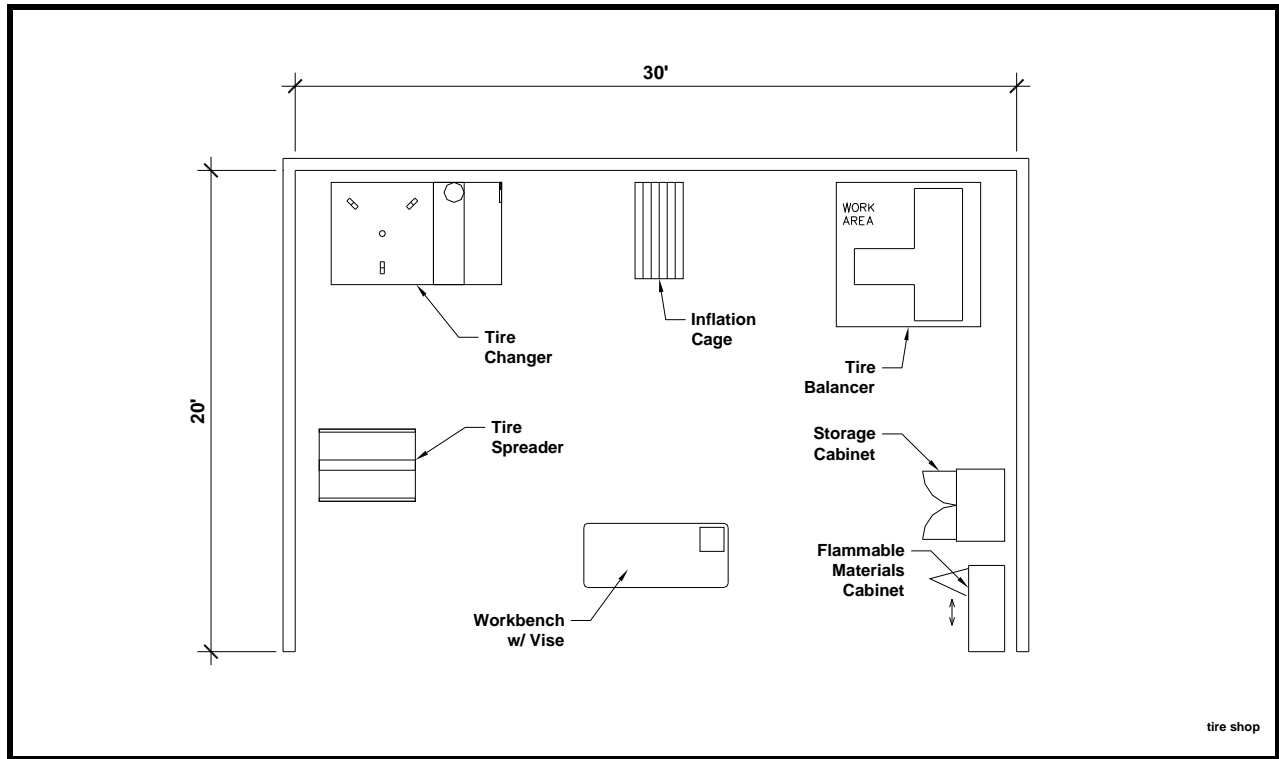

## FUNCTIONAL CHARACTERISTICS

### Function

- Designated area or alcove for tire mounting.

### Relationship to Other Areas

- Adjacent to Tire Bay.

### Critical Dimensions

- 14'-0" vertical clearance.

### Equipment/Furnishings

- Severe use workbench with vise, tire balancer, bus and auto tire changer, tire spreader, flammable materials cabinets, leak test tank, tire inflation cage, and storage cabinets.

### Comments

- Forklift access.

# FUNCTIONAL REQUIREMENTS

---

## TECHNICAL CONSIDERATIONS

### Architectural

- Finishes
  - Floor: Soil, grease, and water resistant concrete with integral non-metallic hardener and clear epoxy sealer. Consider rubber tile flooring in shop area.
  - Walls: Soil and grease resistant. Epoxy painted to 8 feet AFF.
  - Ceiling: Painted exposed structure.
- Doors
  - None

### Structural

- Control joints in floor slab at adequate spacing.
- Structure as needed to support equipment.

### Mechanical

- General ventilation as required by codes.
- As required by equipment.

### Plumbing

- 3/4" water hose bib with standard faucet at 4'-0" AFF.
- Compressed air line with cut-off valve, filter, regulator with gauge, lubricator, and quick disconnects on walls at 4'-0" AFF. Provide disconnects at locations to be determined during detailed design.
- As required by equipment.

### Electrical

- Lighting
  - High bay fluorescent. Refer to chapter 4 for foot candle lighting requirements.
- Power
  - General purpose duplex receptacles, 120VAC, 20A, GFI protected, on walls at 3'-6" AFF.
  - As required by equipment.
- Communications
  - Paging/intercom system speakers.

# FUNCTIONAL REQUIREMENTS

## Tire Storage

(Maintenance – Bays & Shops)

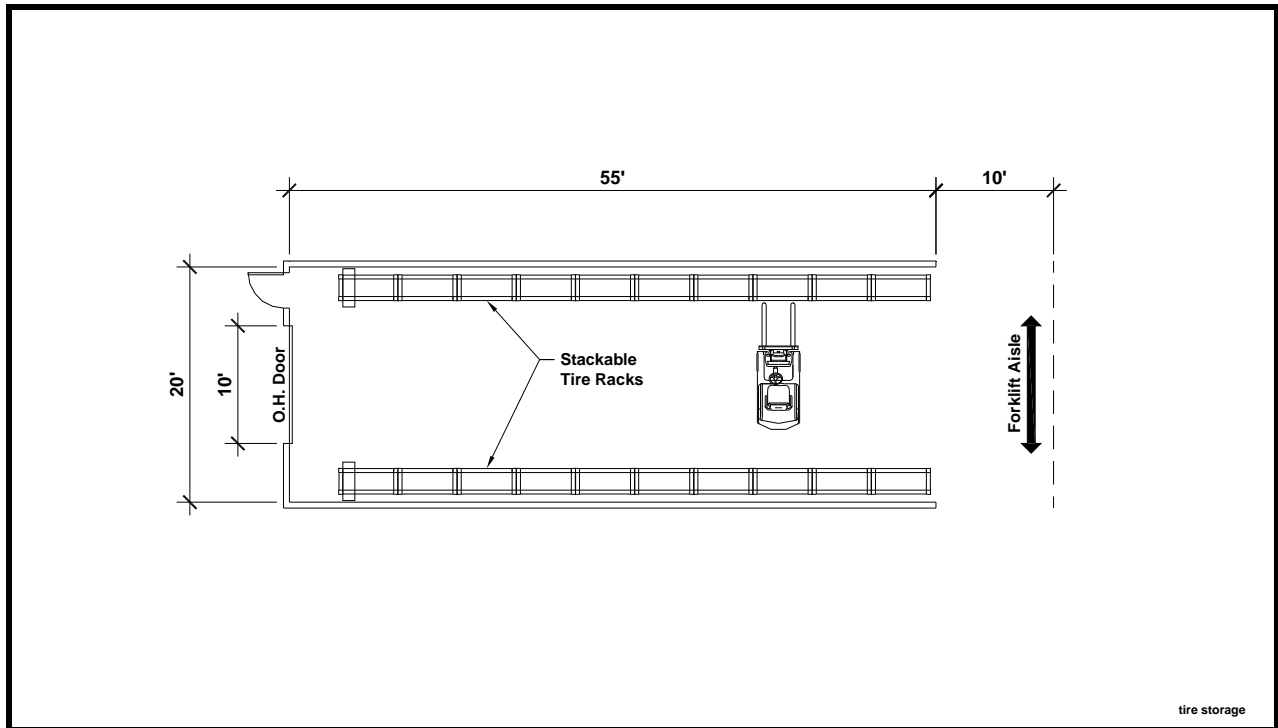

### FUNCTIONAL CHARACTERISTICS

#### Function

- Designated area or alcove for tire storage.

#### Relationship to Other Areas

- Adjacent to repair bays.

#### Critical Dimensions

- 14'-0" vertical clearance.

#### Equipment/Furnishings

- Stackable tire racks and storage cabinets.

#### Comments

- Forklift access.



# FUNCTIONAL REQUIREMENTS

---

## TECHNICAL CONSIDERATIONS

### Architectural

- Finishes
  - Floor: Soil, grease, and water resistant concrete with integral non-metallic hardener and clear epoxy sealer. Consider rubber tile flooring in shop area.
  - Walls: Soil and grease resistant. Epoxy painted to 8 feet AFF.
  - Ceiling: Painted exposed structure.
- Doors
- Personnel doors to meet applicable codes and exiting requirements.
- Exterior overhead door: 10' x 10' motor operated with interior push button controls, and lockout on exterior.

### Structural

- Control joints in floor slab at adequate spacing.
- Structure as needed to support equipment.

### Mechanical

- General ventilation as required by codes.
- As required by equipment.

### Plumbing

- 3/4" water hose bib with standard faucet at 4'-0" AFF.
- Compressed air line with cut-off valve, filter, regulator with gauge, lubricator, and quick disconnects on walls at 4'-0" AFF. Provide disconnects at locations to be determined during detailed design.
- As required by equipment.

### Electrical

- Lighting
  - High bay fluorescent. Refer to Chapter 4 for foot candle lighting requirements.
- Power
  - General purpose duplex receptacles, 120VAC, 20A, GFI protected, on walls at 3'-6" AFF.
  - As required by equipment.
- Communications
  - Paging/intercom system speakers.

# FUNCTIONAL REQUIREMENTS

## Common Work Area

(Maintenance – Bays & Shops)

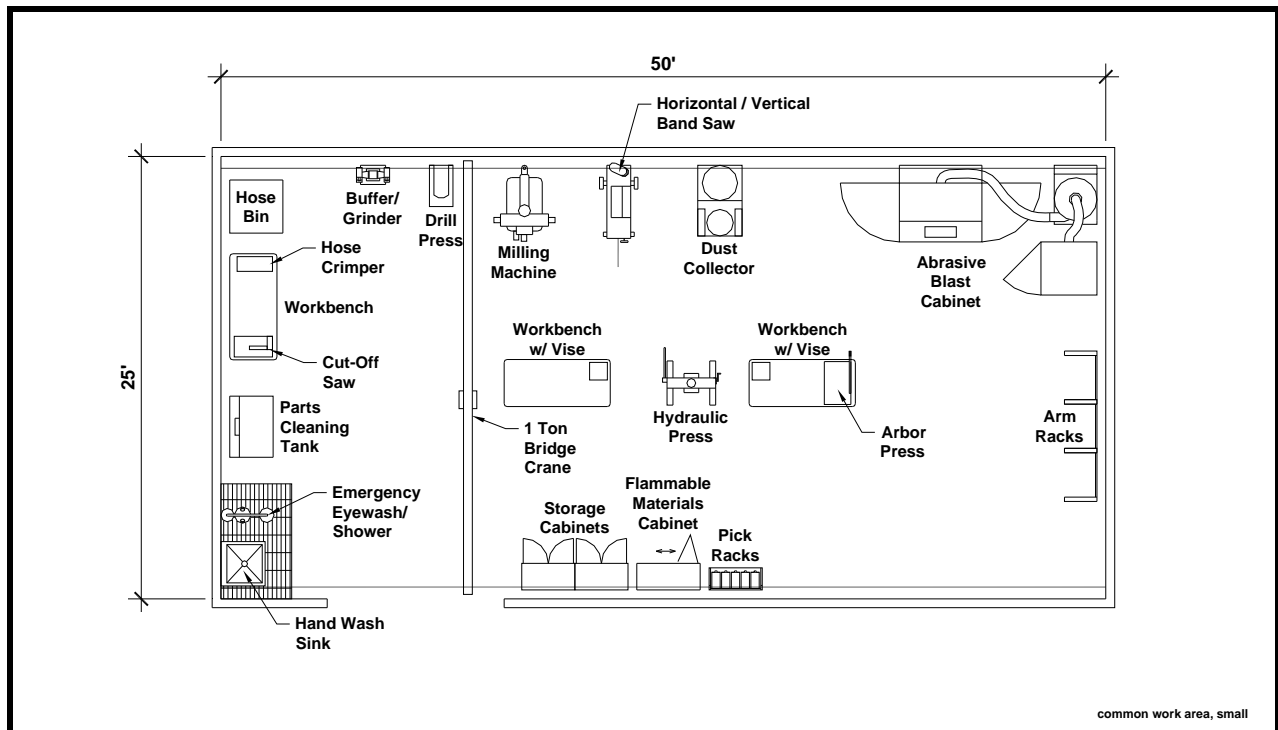

## FUNCTIONAL CHARACTERISTICS

### Function

- Designated area or alcove for bench work and shop equipment that supports the General Repair Bays.

### Relationship to Other Areas

- Adjacent to. General Repair Bays.

### Critical Dimensions

- 14'-0" vertical clearance.

### Equipment/Furnishings

- Severe use workbench w/vises, automotive brake lathe, dust collector, abrasive blast cabinet, drill press, buffer/grinder, hydraulic press, arbor press, milling machine, armature lathe, engine lathe, horizontal/vertical band saw, cut-off saw, hose crimper, parts cleaning tank, welding table, welders, exhaust arm, storage cabinet, flammable materials cabinet, pick rack, hose bin, eyewash/safety shower, and hand wash sink.

### Comments

- Forklift access.
- Exhaust all dust collectors to outside.

# FUNCTIONAL REQUIREMENTS

---

## TECHNICAL CONSIDERATIONS

### Architectural

- Finishes
  - Floor: Soil, grease, and water resistant concrete, with integral non-metallic hardener, and clear epoxy sealer. Provide slip resistant finish.
  - Walls: Soil and grease resistant. Epoxy painted to 8 feet AFF.
  - Ceiling: Painted exposed structure.
- Doors
  - Personnel doors to meet applicable codes and exiting requirements.

### Structural

- Control joints in floor slab at adequate spacing.
- Structure as needed to support equipment.

### Mechanical

- Heating system must be compatible with possible future use of alternative fueled vehicles.
- Ventilation as required by codes to prevent accumulation of explosive mixtures.
- General ventilation as required by codes.
- As required by equipment.

### Plumbing

- 3/4" water hose bib with standard faucet at 4'-0" AFF.
- Compressed air line with cut-off valve, filter, regulator with gauge, lubricator, cleanout valve, and quick disconnects on walls at 4'-0" AFF. Provide disconnects at locations to be determined during detailed design.
- As required by equipment.

### Electrical

- Lighting
  - High bay fluorescent. Refer to chapter 4 for foot candle lighting requirements.
- Power
  - Welding outlet, centrally located, 208 VAC, 1 ph, 50A and 480 VAC, 3 ph, 30A at 3'-6" AFF.
  - General-purpose duplex receptacles, 120 VAC, 20A, GFI protected, on walls at 3'-6" AFF.
  - As required by equipment.
- Communications
  - Paging/intercom system speakers.

# FUNCTIONAL REQUIREMENTS

## Brake Shop

(Maintenance – Bays & Shops)

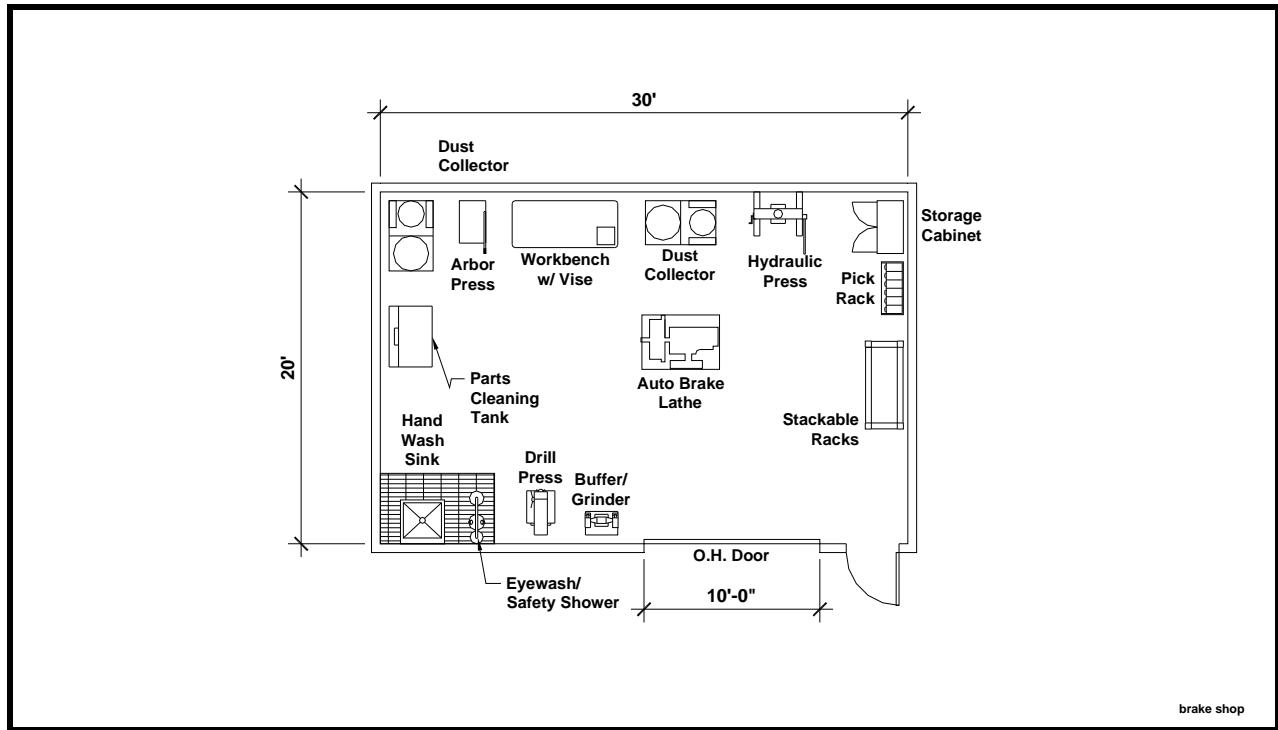

## FUNCTIONAL CHARACTERISTICS

### Function

- Designated area or alcove for brake repair and pallet storage for up to 30 brake packages.

### Relationship to Other Areas

- Near Component Rebuild / Unit Shop.

### Critical Dimensions

- 14'-0" vertical clearance.

### Equipment/Furnishings

- Severe use workbench w/vise, buffer/grinder, 80-ton hydraulic press, abrasive blast cabinet, 2 Star Transmatic brake lathes, high lift dual wheel dollies, brake lathe dust collector with exterior exhaust, stackable racks for front/rear brake packages, shop desk, and shop storage cabinet.

### Comments

- Forklift access.
- Exhaust all dust collectors to outside.
- Provide for 6 pallets of brake drums (20 per pallet).

# FUNCTIONAL REQUIREMENTS

---

## TECHNICAL CONSIDERATIONS

### Architectural

- Finishes
  - Floor: Soil, grease, and water resistant concrete, with integral non-metallic hardener, and clear epoxy sealer. Provide slip resistant finish.
  - Walls: Soil and grease resistant. Epoxy painted to 8 feet AFF.
  - Ceiling: Painted exposed structure.
- Doors
  - Personnel doors to meet applicable codes and exiting requirements.
  - Interior overhead door: 10' x 10' motor operated with push button controls.

### Structural

- Control joints in floor slab at adequate spacing.
- Structure as needed to support equipment.

### Mechanical

- Heating system must be compatible with possible future use of alternative fueled vehicles.
- Ventilation as required by codes to prevent accumulation of explosive mixtures.
- General ventilation as required by codes.
- As required by equipment.

### Plumbing

- 3/4" water hose bib with standard faucet at 4'-0" AFF.
- Compressed air line with cut-off valve, filter, regulator with gauge, lubricator, cleanout valve, and quick disconnects on walls at 4'-0" AFF. Provide disconnects at locations to be determined during detailed design.
- As required by equipment.

### Electrical

- Lighting
  - High bay fluorescent. Refer to chapter 4 for foot candle lighting requirements.
- Power
  - Welding outlet, centrally located, 208 VAC, 1 ph, 50A and 480 VAC, 3 ph, 30A at 3'-6" AFF.
  - General-purpose duplex receptacles, 120 VAC, 20A, GFI protected, on walls at 3'-6" AFF.
  - As required by equipment.
- Communications
  - Paging/intercom system speakers.

# FUNCTIONAL REQUIREMENTS

Electronics / Farebox Shop

(Maintenance – Bays & Shops)

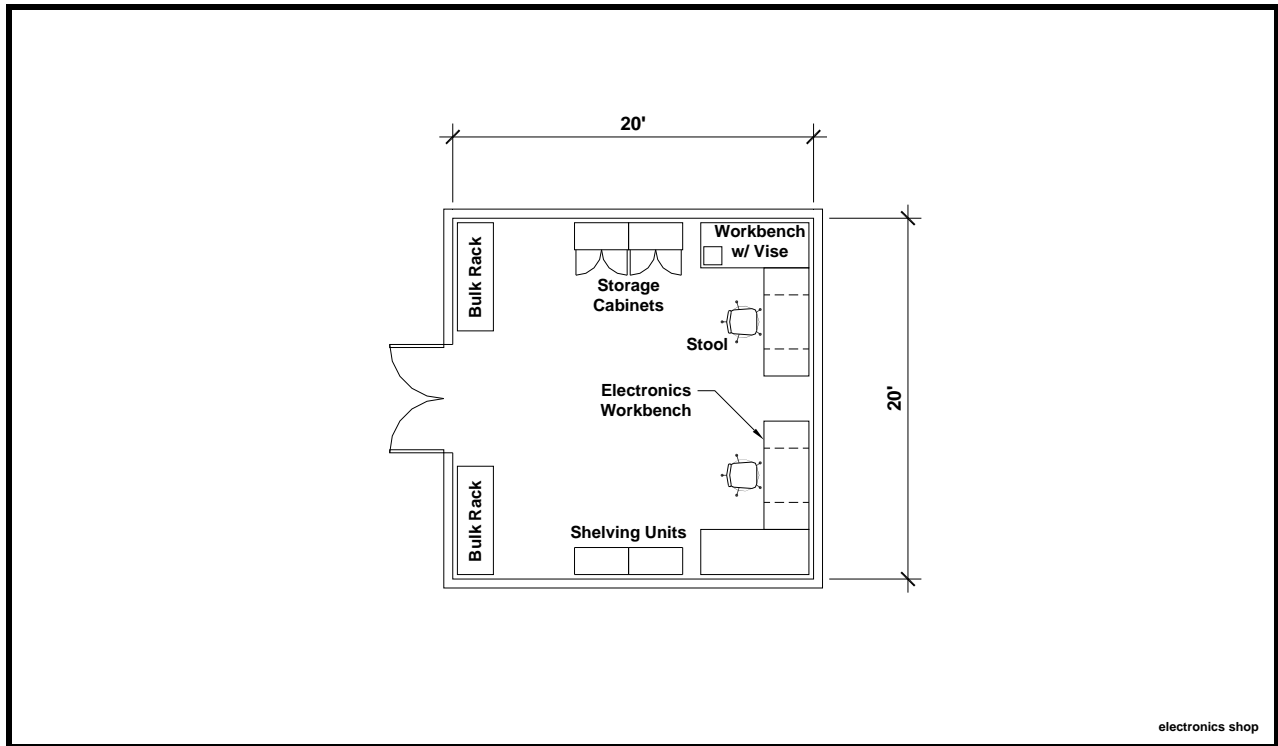

## FUNCTIONAL CHARACTERISTICS

### Function

- Designated area for repair of electrical components.

### Relationship to Other Areas

- In a visible location.

### Critical Dimensions

- 10'-0" vertical clearance minimum.

### Equipment/Furnishings

- Electronics workbenches with electronics vise, soldering, portable testing carts, bench mounted soldering fume extractor.

### Comments

- Separated from shop areas to prevent dust migration

# FUNCTIONAL REQUIREMENTS

---

## TECHNICAL CONSIDERATIONS

### Architectural

- Finishes
  - Floor: Soil, grease, and water resistant concrete, with integral non-metallic hardener, and clear epoxy sealer. Provide slip resistant finish.
  - Walls: Soil and grease resistant. Epoxy painted to 8 feet AFF.
  - Ceiling: Painted exposed structure.
- Doors
  - Personnel doors to meet applicable codes and exiting requirements.

### Structural

- Control joints in floor slab at adequate spacing.
- Structure as needed to support equipment.

### Mechanical

- Heating system must be compatible with possible future use of alternative fueled vehicles.
- Ventilation as required by codes to prevent accumulation of explosive mixtures.
- General ventilation as required by codes.
- As required by equipment.

### Plumbing

- 3/4" water hose bib with standard faucet at 4'-0" AFF.
- Compressed air line with cut-off valve, filter, regulator with gauge, lubricator, cleanout valve, and quick disconnects on walls at 4'-0" AFF. Provide disconnects at locations to be determined during detailed design.
- As required by equipment.

### Electrical

- Lighting
  - Fluorescent. Refer to chapter 4 for foot candle lighting requirements.
- Power
  - Welding outlet, centrally located, 208 VAC, 1 ph, 50A and 480 VAC, 3 ph, 30A at 3'-6" AFF.
  - General-purpose duplex receptacles, 120 VAC, 20A, GFI protected, on walls at 3'-6" AFF.
  - As required by equipment.
- Communications
  - Paging/intercom system speakers.

# FUNCTIONAL REQUIREMENTS

## Body Repair Bay (Standard Buses)

(Maintenance – Bays & Shops)

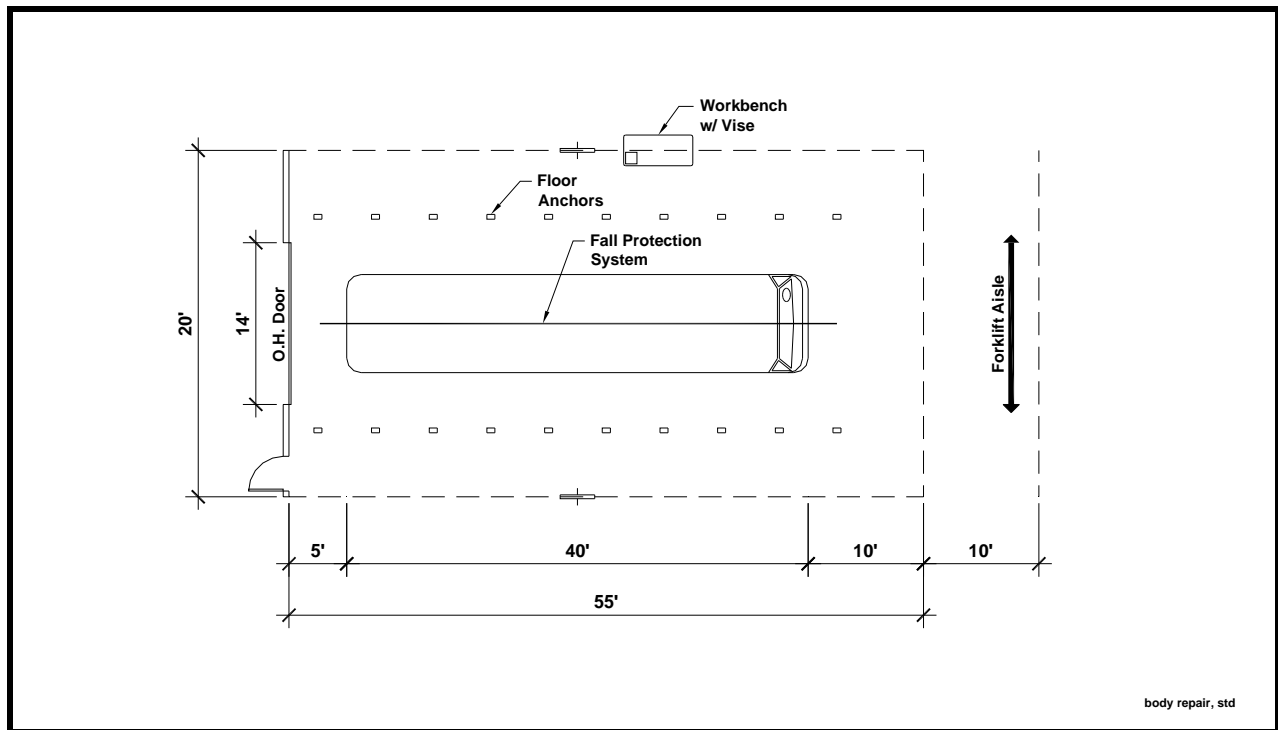

## FUNCTIONAL CHARACTERISTICS

### Function

- Bay for body repairs on standard buses.

### Relationship to Other Areas

- Adjacent to Paint Prep Bay.

### Critical Dimensions

- 19'-0" vertical clearance.
- 20'-0" wide by 55'-0" long

### Equipment/Furnishings

- Floor anchors, fall protection system with overhead monorail beam, air/electric trapeze, and severe use workbench w/ vise.

### Comments

- Forklift access.



# FUNCTIONAL REQUIREMENTS

---

## TECHNICAL CONSIDERATIONS

### Architectural

- Finishes
  - Floor: Soil, grease, and water resistant concrete, with integral non-metallic hardener, and clear epoxy sealer. Provide slip resistant finish.
  - Walls: Soil and grease resistant. Epoxy painted to 8 feet AFF.
  - Ceiling: Painted exposed structure.
- Doors
  - Personnel doors to meet applicable codes and exiting requirements.
  - Exterior overhead door: 14' x 14' motor operated with interior push button controls, and lockout on exterior.
- Bollards on exterior at jambs of overhead door (2 per door).

### Structural

- Control joints in floor slab at adequate spacing.
- Structure as needed to support equipment.

### Mechanical

- Heating system must be compatible with possible future use of alternative fueled vehicles.
- Ventilation as required by codes to prevent accumulation of explosive mixtures.
- General ventilation as required by codes.
- As required by equipment.

### Plumbing

- 3/4" water hose bib with standard faucet at 4'-0" AFF.
- Compressed air line with cut-off valve, filter regulator with gauge, lubricator, cleanout valve, and quick disconnects on walls at 4'-0" AFF. Provide disconnects at locations to be determined during detailed design.
- As required by equipment.

### Electrical

- Lighting
  - High bay fluorescent. Refer to chapter 4 for foot candle lighting requirements.
- Power
  - Welding outlet, centrally located, 208VAC, 1ph, 50A and 480VAC, 3ph, 30A at 3'-6" AFF.
  - General-purpose duplex receptacles, 120VAC, 20A, GFI protected, on walls at 3'-6" AFF.
  - As required by equipment.
- Communications
  - Paging/intercom system speakers.
  - Data port in each repair bay at columns and/or on air/electric trapeze at workbench locations in bay.

# FUNCTIONAL REQUIREMENTS

## Body Repair Bay (Articulated Buses)

(Maintenance – Bays & Shops)

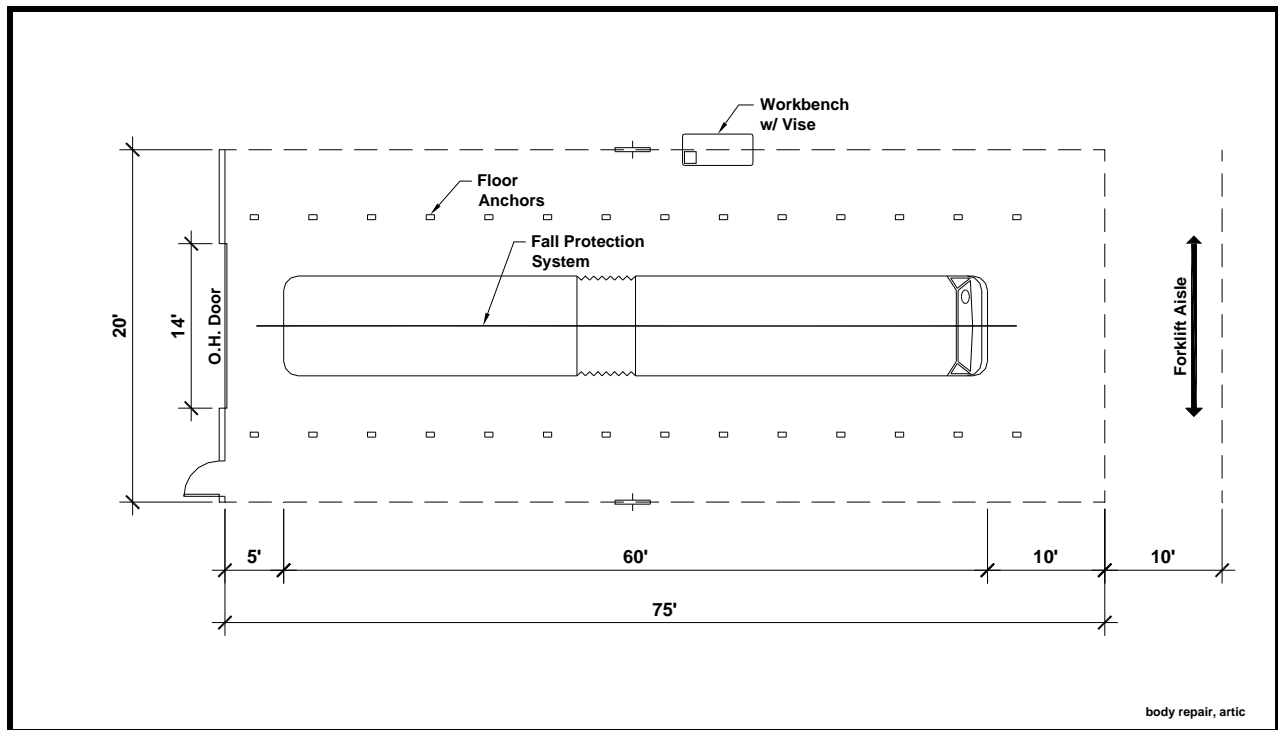

## FUNCTIONAL CHARACTERISTICS

### Function

- Bay for body repairs on articulated buses.

### Relationship to Other Areas

- Adjacent to Paint Prep Bay.

### Critical Dimensions

- 19'-0" vertical clearance.
- 20'-0" wide by 75'-0" long

### Equipment/Furnishings

- Floor anchors, fall protection system with overhead monorail beam, air/electric trapeze and, severe use workbench w/ vise.

### Comments

- Forklift access.

# FUNCTIONAL REQUIREMENTS

---

## TECHNICAL CONSIDERATIONS

### Architectural

- Finishes
  - Floor: Soil, grease, and water resistant concrete, with integral non-metallic hardener, and clear epoxy sealer. Provide slip resistant finish.
  - Walls: Soil and grease resistant. Epoxy painted to 8 feet AFF.
  - Ceiling: Painted exposed structure.
- Doors
  - Personnel doors to meet applicable codes and exiting requirements.
  - Exterior overhead door: 14' x 14' motor operated with interior push button controls, and lockout on exterior.
- Bollards on exterior at jambs of overhead door (2 per door).

### Structural

- Control joints in floor slab at adequate spacing.
- Structure as needed to support equipment.

### Mechanical

- Heating system must be compatible with possible future use of alternative fueled vehicles.
- Ventilation as required by codes to prevent accumulation of explosive mixtures.
- General ventilation as required by codes.
- As required by equipment.

### Plumbing

- 3/4" water hose bib with standard faucet at 4'-0" AFF.
- Compressed air line with cut-off valve, filter regulator with gauge, lubricator, cleanout valve, and quick disconnects on walls at 4'-0" AFF. Provide disconnects at locations to be determined during detailed design.
- As required by equipment.

### Electrical

- Lighting
  - High bay fluorescent. Refer to chapter 4 for foot candle lighting requirements.
- Power
  - Welding outlet, centrally located, 208VAC, 1ph, 50A and 480VAC, 3ph, 30A at 3'-6" AFF.
  - General-purpose duplex receptacles, 120VAC, 20A, GFI protected, on walls at 3'-6" AFF.
  - As required by equipment.
- Communications
  - Paging/intercom system speakers.
  - Data port in each repair bay at columns and/or on air/electric trapeze at workbench locations in bay.

# FUNCTIONAL REQUIREMENTS

Paint Prep /Body Repair Bay (Standard Buses)

(Maintenance – Bays & Shops)

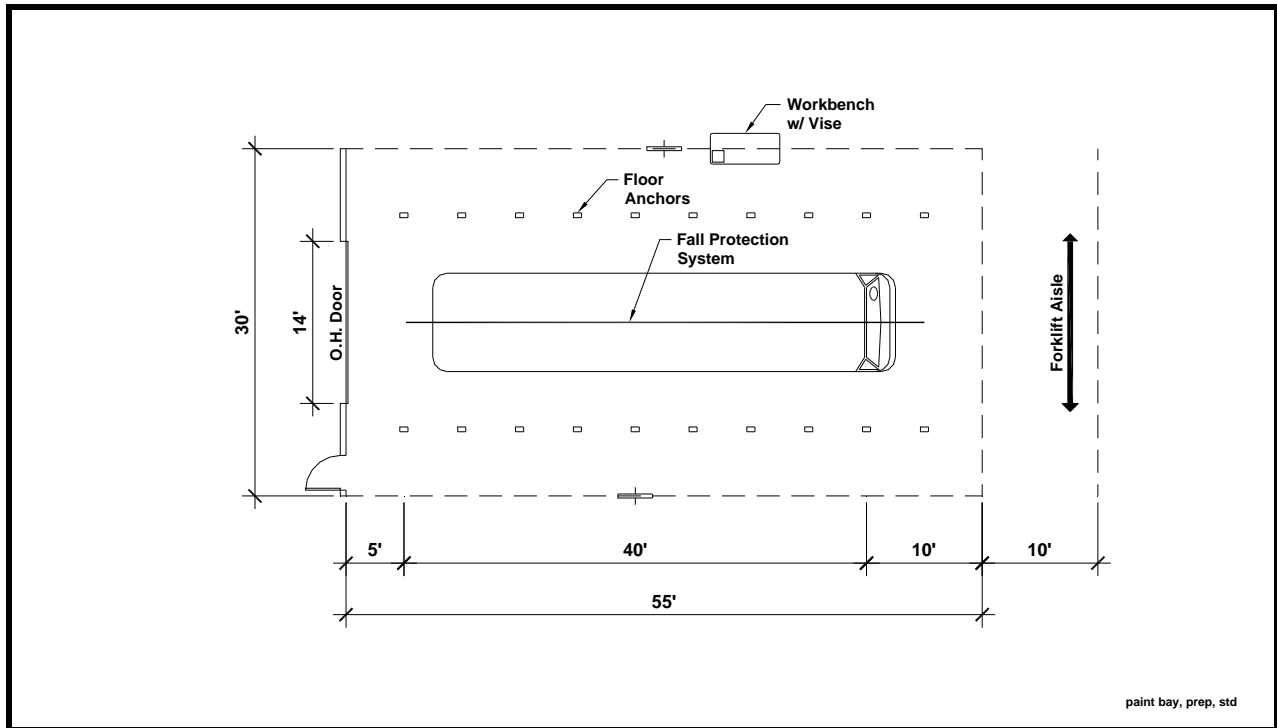

## FUNCTIONAL CHARACTERISTICS

### Function

- Bay for preparing articulated buses and components to be painted.

### Relationship to Other Areas

- In-line with Paint Booth.
- Adjacent to Body Repair Bay.

### Critical Dimensions

- 19'-0" vertical clearance.
- 30'-0" wide by 55'-0" long

### Equipment/Furnishings

- Floor anchors, fall protection system with overhead monorail beam, air/electric trapeze, and severe use workbench w/ vise.

### Comments

- Forklift access.

# FUNCTIONAL REQUIREMENTS

---

## TECHNICAL CONSIDERATIONS

### Architectural

- Finishes
  - Floor: Soil, grease, and water resistant concrete, with integral non-metallic hardener, and clear epoxy sealer. Provide slip resistant finish.
  - Walls: Soil and grease resistant. Epoxy painted to 8 feet AFF.
  - Ceiling: Painted exposed structure.
- Doors
  - Personnel doors to meet applicable codes and exiting requirements.
  - Exterior overhead door: 14' x 14' motor operated with interior push button controls, and lockout on exterior.
- Bollards on exterior at jambs of overhead door (2 per door).

### Structural

- Control joints in floor slab at adequate spacing.
- Structure as needed to support equipment.

### Mechanical

- Heating system must be compatible with possible future use of alternative fueled vehicles.
- Ventilation as required by codes to prevent accumulation of explosive mixtures.
- General ventilation as required by codes.
- As required by equipment.

### Plumbing

- 3/4" water hose bib with standard faucet at 4'-0" AFF.
- Compressed air line with cut-off valve, filter regulator with gauge, lubricator, cleanout valve, and quick disconnects on walls at 4'-0" AFF. Provide disconnects at locations to be determined during detailed design.
- As required by equipment.

### Electrical

- Lighting
  - High bay fluorescent. Refer to chapter 4 for foot candle lighting requirements.
- Power
  - Welding outlet, centrally located, 208VAC, 1ph, 50A and 480VAC, 3ph, 30A at 3'-6" AFF.
  - General-purpose duplex receptacles, 120VAC, 20A, GFI protected, on walls at 3'-6" AFF.
  - As required by equipment.
- Communications
  - Paging/intercom system speakers.
  - Data port in each repair bay at columns and/or on air/electric trapeze at workbench locations in bay.

# FUNCTIONAL REQUIREMENTS

## Paint Prep /Body Repair Bay (Articulated Buses)

(Maintenance – Bays & Shops)

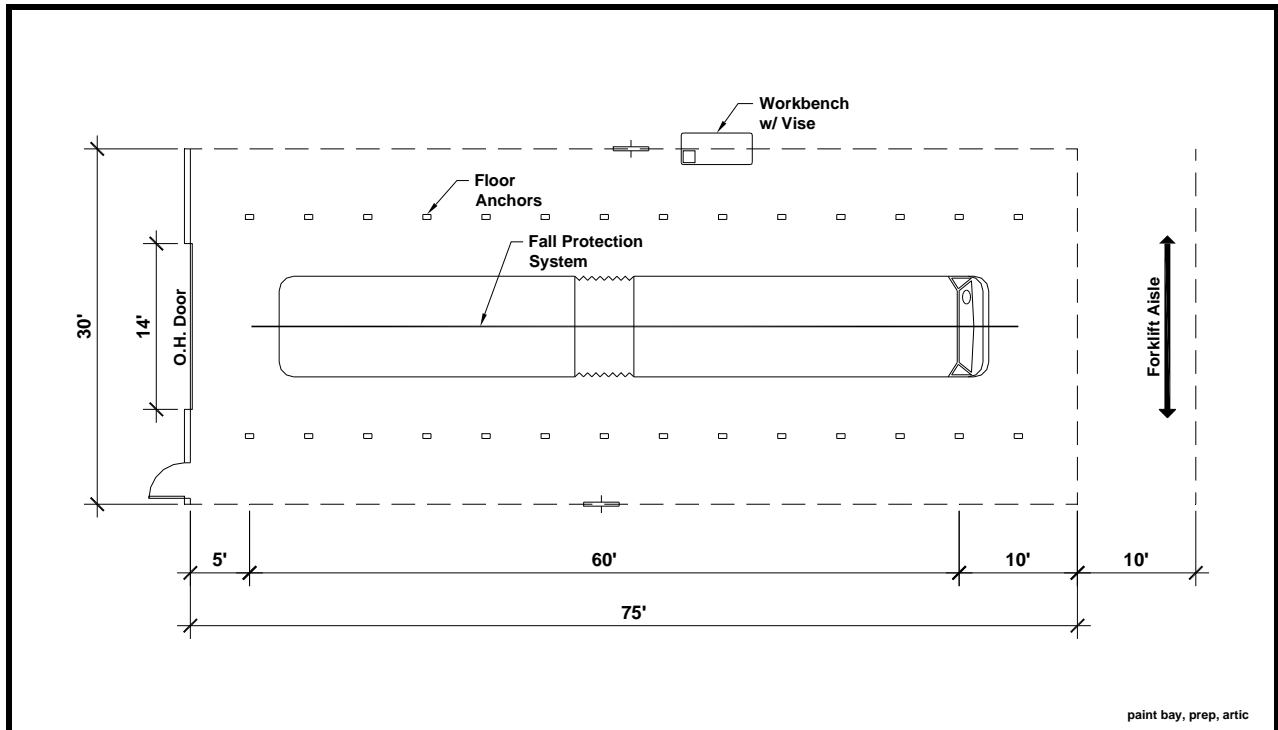

### FUNCTIONAL CHARACTERISTICS

#### Function

- Bay for preparing articulated buses and components to be painted.

#### Relationship to Other Areas

- In-line with Paint Booth.
- Adjacent to Body Repair Bay.

#### Critical Dimensions

- 19'-0" vertical clearance.
- 30'-0" wide by 75'-0" long

#### Equipment/Furnishings

- Floor anchors, fall protection system with overhead monorail beam, air/electric trapeze and, severe use workbench w/ vise.

#### Comments

- Forklift access.

# FUNCTIONAL REQUIREMENTS

---

## TECHNICAL CONSIDERATIONS

### Architectural

- Finishes
  - Floor: Soil, grease, and water resistant concrete, with integral non-metallic hardener, and clear epoxy sealer. Provide slip resistant finish.
  - Walls: Soil and grease resistant. Epoxy painted to 8 feet AFF.
  - Ceiling: Painted exposed structure.
- Doors
  - Personnel doors to meet applicable codes and exiting requirements.
  - Exterior overhead door: 14' x 14' motor operated with interior push button controls, and lockout on exterior.
- Bollards on exterior at jambs of overhead door (2 per door).

### Structural

- Control joints in floor slab at adequate spacing.
- Structure as needed to support equipment.

### Mechanical

- Heating system must be compatible with possible future use of alternative fueled vehicles.
- Ventilation as required by codes to prevent accumulation of explosive mixtures.
- General ventilation as required by codes.
- As required by equipment.

### Plumbing

- 3/4" water hose bib with standard faucet at 4'-0" AFF.
- Compressed air line with cut-off valve, filter regulator with gauge, lubricator, cleanout valve, and quick disconnects on walls at 4'-0" AFF. Provide disconnects at locations to be determined during detailed design.
- As required by equipment.

### Electrical

- Lighting
  - High bay fluorescent. Refer to chapter 4 for foot candle lighting requirements.
- Power
  - Welding outlet, centrally located, 208VAC, 1ph, 50A and 480VAC, 3ph, 30A at 3'-6" AFF.
  - General-purpose duplex receptacles, 120VAC, 20A, GFI protected, on walls at 3'-6" AFF.
  - As required by equipment.
- Communications
  - Paging/intercom system speakers.
  - Data port in each repair bay at columns and/or on air/electric trapeze at workbench locations in bay.

# FUNCTIONAL REQUIREMENTS

Paint Booth Bay (Standard Buses)

(Maintenance – Bays & Shops)

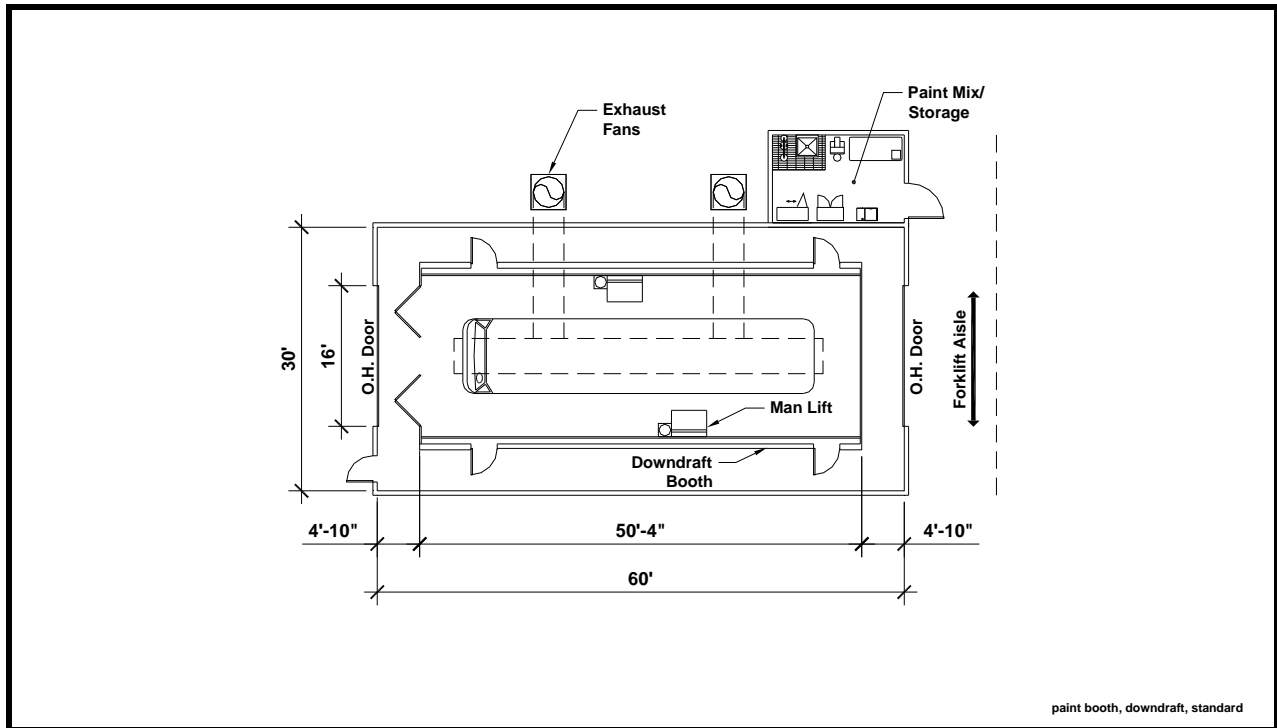

## FUNCTIONAL CHARACTERISTICS

### Function

- Down draft paint booth for painting standard buses and components.

### Relationship to Other Areas

- In-line with Paint Prep Bay.
- Adjacent to Body Repair Bay.

### Critical Dimensions

- 19'-0" vertical clearance.
- 30'-0" wide by 60'-0" long

### Equipment/Furnishings

- Down draft type paint booth for both water and solvent based paints, two 3 axis man lifts (on each side of the booth), drying lamp bank, and breathable air system.

### Comments

- Forklift access.
- Man-lift must be capable of traveling across the front and rear of a bus in the booth.
- Paint booth to have required fire separation per applicable Codes.



# FUNCTIONAL REQUIREMENTS

---

## TECHNICAL CONSIDERATIONS

### Architectural

- Finishes
  - Floor: Soil, grease, and water resistant concrete, with integral non-metallic hardener, and clear epoxy sealer. Provide slip resistant finish.
  - Walls: Soil and grease resistant. Epoxy painted to 8 feet AFF.
  - Ceiling: Painted exposed structure.
- Doors
  - Personnel doors to meet applicable codes and exiting requirements.
  - Exterior overhead door: 14' x 14' motor operated with interior push button controls, and lockout on exterior.
- Bollards on exterior at jambs of overhead door (2 per door).

### Structural

- Control joints in floor slab at adequate spacing.
- Structure as needed to support equipment.

### Mechanical

- Heating system must be compatible with possible future use of alternative fueled vehicles.
- Ventilation as required by codes to prevent accumulation of explosive mixtures.
- General ventilation as required by codes.
- Heated air make-up unit with clean air intake by booth manufacturer.
- As required by equipment.

### Plumbing

- 3/4" water hose bib with standard faucet at 4'-0" AFF.
- Compressed air line with cut-off valve, filter regulator with gauge, lubricator, cleanout valve, and quick disconnects on walls at 4'-0" AFF. Provide disconnects at locations to be determined during detailed design.
- As required by equipment.

### Electrical

- Lighting
  - High bay fluorescent. Refer to chapter 4 for foot candle lighting requirements.
- Power
  - Welding outlet, centrally located, 208VAC, 1ph, 50A and 480VAC, 3ph, 30A at 3'-6" AFF.
  - General-purpose duplex receptacles, 120VAC, 20A, GFI protected, on walls at 3'-6" AFF.
  - As required by equipment.
- Communications
  - Paging/intercom system speakers.
  - Data port in each repair bay at columns and/or on air/electric trapeze at workbench locations in bay.

# FUNCTIONAL REQUIREMENTS

## Paint Booth Bay (Articulated Buses)

(Maintenance – Bays & Shops)

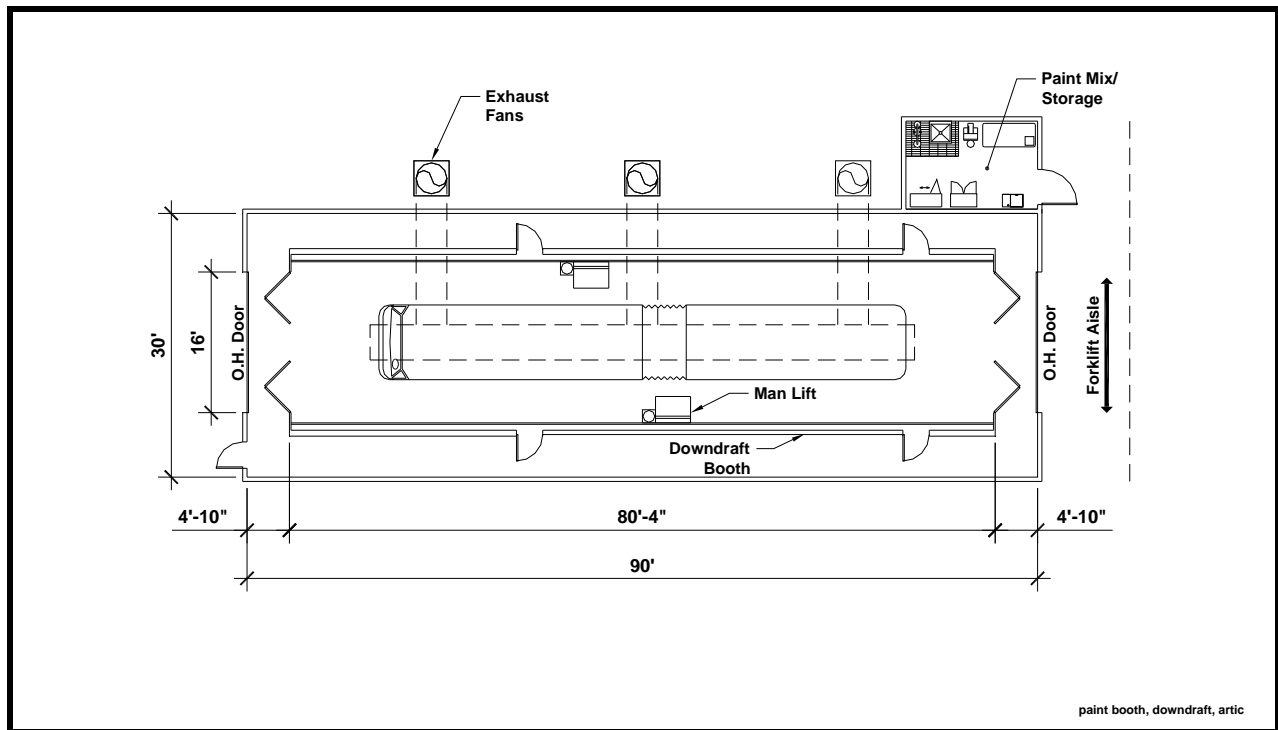

## FUNCTIONAL CHARACTERISTICS

### Function

- Down draft paint booth for painting articulated buses and components.

### Relationship to Other Areas

- In-line with Paint Prep Bay.
- Adjacent to Body Repair Bay.

### Critical Dimensions

- 19'-0" vertical clearance.
- 30'-0" wide by 90'-0" long

### Equipment/Furnishings

- Down draft type paint booth for both water and solvent based paints, two 3 axis man lifts (on each side of the booth), drying lamp bank, and breathable air system.

### Comments

- Forklift access.
- Man-lift must be capable of traveling across the front and rear of a bus in the booth.
- Paint booth to have required fire separation per applicable Codes.

# FUNCTIONAL REQUIREMENTS

---

## TECHNICAL CONSIDERATIONS

### Architectural

- Finishes
  - Floor: Soil, grease, and water resistant concrete, with integral non-metallic hardener, and clear epoxy sealer. Provide slip resistant finish.
  - Walls: Soil and grease resistant. Epoxy painted to 8 feet AFF.
  - Ceiling: Painted exposed structure.
- Doors
  - Personnel doors to meet applicable codes and exiting requirements.
  - Exterior overhead door: 14' x 14' motor operated with interior push button controls, and lockout on exterior.
- Bollards on exterior at jambs of overhead door (2 per door).

### Structural

- Control joints in floor slab at adequate spacing.
- Structure as needed to support equipment.

### Mechanical

- Heating system must be compatible with possible future use of alternative fueled vehicles.
- Ventilation as required by codes to prevent accumulation of explosive mixtures.
- General ventilation as required by codes.
- Heated air make-up unit with clean air intake by booth manufacturer.
- As required by equipment.

### Plumbing

- 3/4" water hose bib with standard faucet at 4'-0" AFF.
- Compressed air line with cut-off valve, filter regulator with gauge, lubricator, cleanout valve, and quick disconnects on walls at 4'-0" AFF. Provide disconnects at locations to be determined during detailed design.
- As required by equipment.

### Electrical

- Lighting
  - High bay fluorescent. Refer to chapter 4 for foot candle lighting requirements.
- Power
  - Welding outlet, centrally located, 208VAC, 1ph, 50A and 480VAC, 3ph, 30A at 3'-6" AFF.
  - General-purpose duplex receptacles, 120VAC, 20A, GFI protected, on walls at 3'-6" AFF.
  - As required by equipment.
- Communications
  - Paging/intercom system speakers.
  - Data port in each repair bay at columns and/or on air/electric trapeze at workbench locations in bay.

# FUNCTIONAL REQUIREMENTS

Welding / Body Shop

(Maintenance – Bays & Shops)

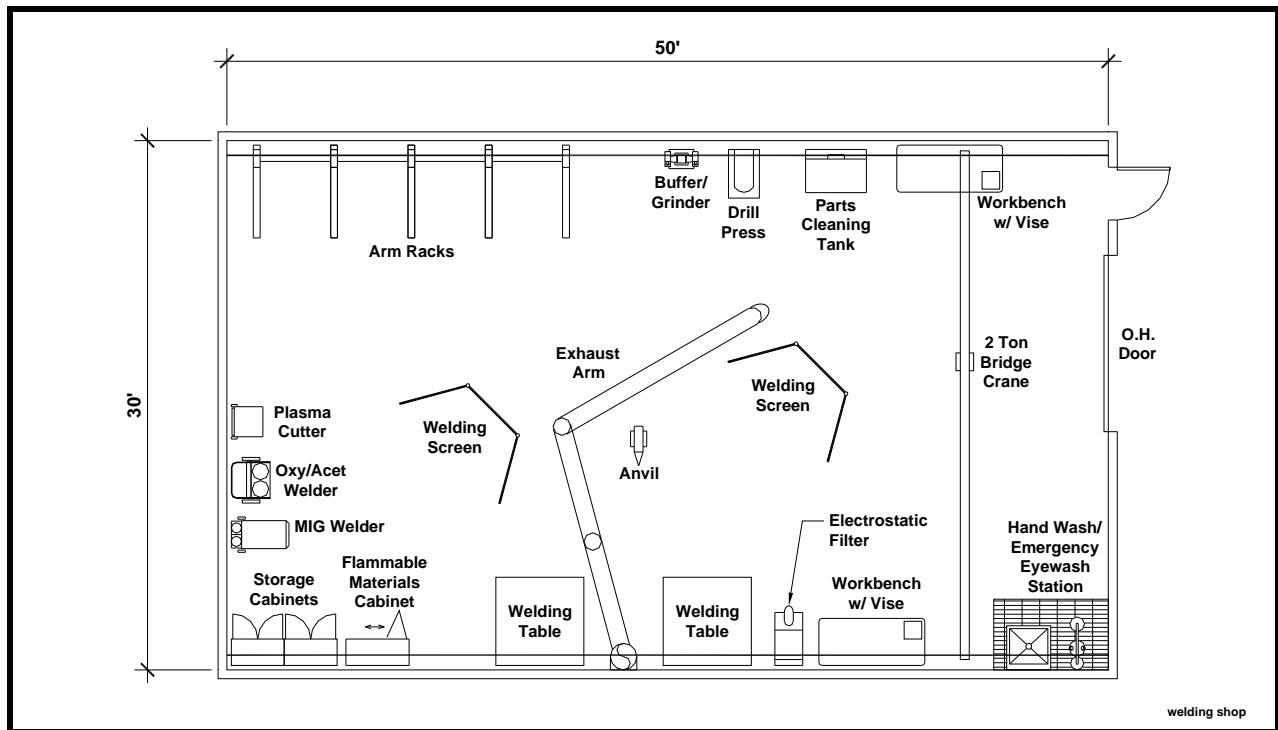

## FUNCTIONAL CHARACTERISTICS

### Function

- Designated area or alcove for welding, benchwork and shop equipment that supports the Maintenance Bays.

### Relationship to Other Areas

- Adjacent to Maintenance Bays.

### Critical Dimensions

- 14'-0" vertical clearance.

### Equipment/Furnishings

- Severe use workbench w/vise, buffer/grinder, 80-ton hydraulic press, parts cleaning tank, anvil w/stand, drill press, arbor press, welding table, MIG/TIG welder, oxyacetylene welder, dry rod oven, armature lathe, buffer/grinder, hose repair station, band saw, welding curtain, electrostatic filter, 1 ton suspended bridge crane, eyewash/safety shower, and shop storage cabinet.

### Comments

- Forklift access.

# FUNCTIONAL REQUIREMENTS

---

## TECHNICAL CONSIDERATIONS

### Architectural

- Finishes
  - Floor: Soil, grease, and water resistant concrete, with integral non-metallic hardener, and clear epoxy sealer. Provide slip resistant finish.
  - Walls: Soil and grease resistant. Epoxy painted to 8 feet AFF.
  - Ceiling: Painted exposed structure.
- Doors
  - Personnel doors to meet applicable codes and exiting requirements.
  - Exterior overhead door: 14' x 14' motor operated with interior push button controls, and lockout on exterior.
- Bollards on exterior at jambs of overhead door (2 per door).

### Structural

- Control joints in floor slab at adequate spacing.
- Structure as needed to support equipment.

### Mechanical

- Heating system must be compatible with possible future use of alternative fueled vehicles.
- Ventilation as required by codes to prevent accumulation of explosive mixtures.
- General ventilation as required by codes.
- As required by equipment.

### Plumbing

- 3/4" water hose bib with standard faucet at 4'-0" AFF.
- Compressed air line with cut-off valve, filter, regulator with gauge, lubricator, cleanout valve, and quick disconnects on walls at 4'-0" AFF. Provide disconnects at locations to be determined during detailed design.
- As required by equipment.

### Electrical

- Lighting
  - High bay fluorescent. Refer to chapter 4 for foot candle lighting requirements.
- Power
  - Welding outlet, centrally located, 208 VAC, 1 ph, 50A and 480 VAC, 3 ph, 30A at 3'-6" AFF.
  - General-purpose duplex receptacles, 120 VAC, 20A, GFI protected, on walls at 3'-6" AFF.
  - As required by equipment.
- Communications
  - Paging/intercom system speakers.

# FUNCTIONAL REQUIREMENTS

## Battery Charging Room

(Maintenance – Bays & Shops)

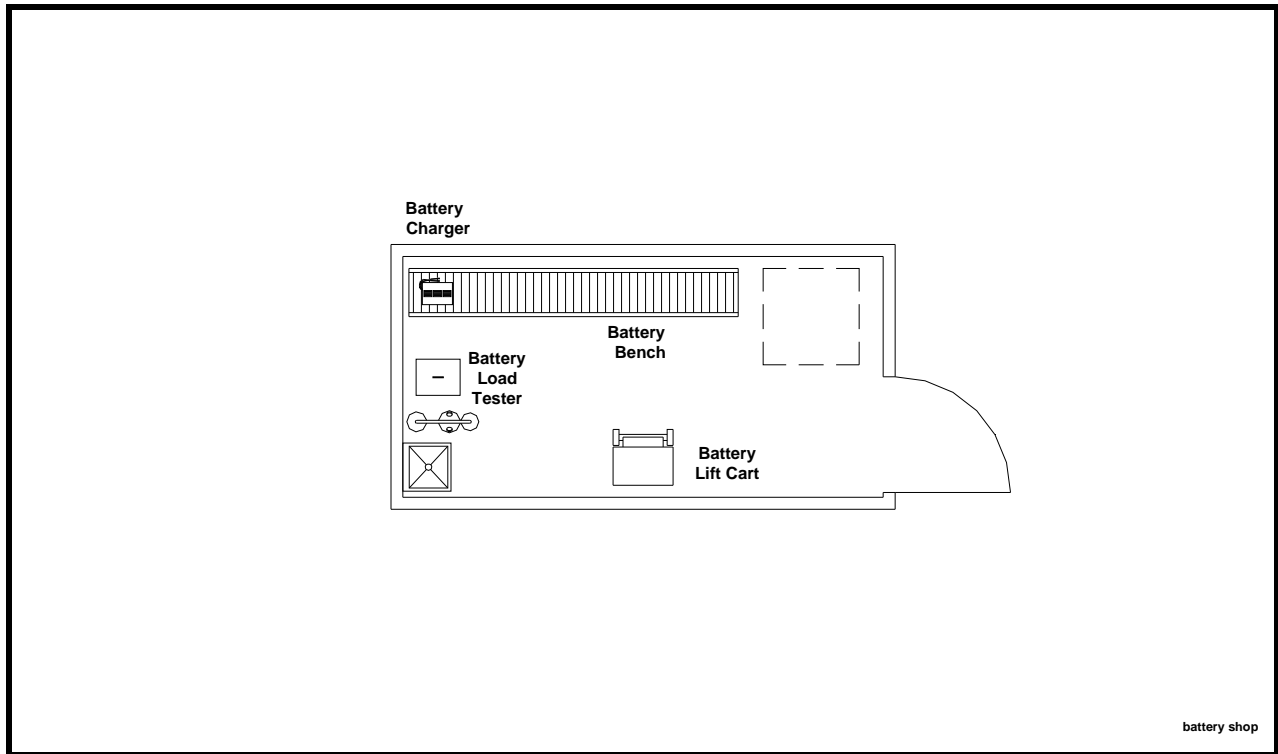

## FUNCTIONAL CHARACTERISTICS

### Function

- Enclosed secure area for the storage and charging of batteries.

### Relationship to Other Areas

- Near General Repair Bays.

### Critical Dimensions

- 14'-0" vertical clearance.

### Equipment/Furnishings

- Hardwood bench for batteries, de-ionizer, acid-neutralizing drain, battery charger with bus bar, battery load tester, wash basin, battery lift cart, battery storage containment pallet, and emergency eyewash/safety shower with alarm.

### Comments

- Forklift access.
- Consider using pre-engineered portable building in lieu of a specially designed room.

# FUNCTIONAL REQUIREMENTS

---

## TECHNICAL CONSIDERATIONS

### Architectural

- Finishes
  - Floor: Soil, grease, and water resistant concrete, with integral non-metallic hardener, and clear epoxy sealer. Provide white slip resistant finish.
  - Walls: Soil and grease resistant. Epoxy painted to 8'-0" AFF.
  - Ceiling: Painted exposed structure.
- Doors
  - Personnel doors to meet applicable codes and exiting requirements.

### Structural

- Control joints in floor slab at adequate spacing.
- Structure as needed to support equipment.

### Mechanical

- Bi-level ventilation as required by codes to prevent accumulation of explosive mixtures.
- General ventilation as required by codes.
- All ductwork serving this space to be stainless steel.
- All fans to be explosion proof and made of material that will not corrode in presence of sulfuric acid.
- As required by equipment.

### Plumbing

- Acid neutralizing drain that leads to waste water treatment plant.
- 3/4" water hose bib with standard faucet at 3'-6" AFF.
- Compressed air line with cut-off valve, filter, regulator with gauge, lubricator, cleanout valve, and quick disconnects on walls at 3'-6" AFF. Provide disconnects at locations to be determined during detailed design.
- As required by equipment.

### Electrical

- Lighting
  - High bay fluorescent. Refer to chapter 4 for foot candle lighting requirements.
- Power
  - General-purpose duplex receptacles, 120 VAC, 20A, GFI protected, on walls at 3'-6" AFF.
  - As required by equipment.
- Communications
  - Paging/intercom system speakers.

# FUNCTIONAL REQUIREMENTS

## Lube/Compressor Room

(Maintenance – Bays & Shops)

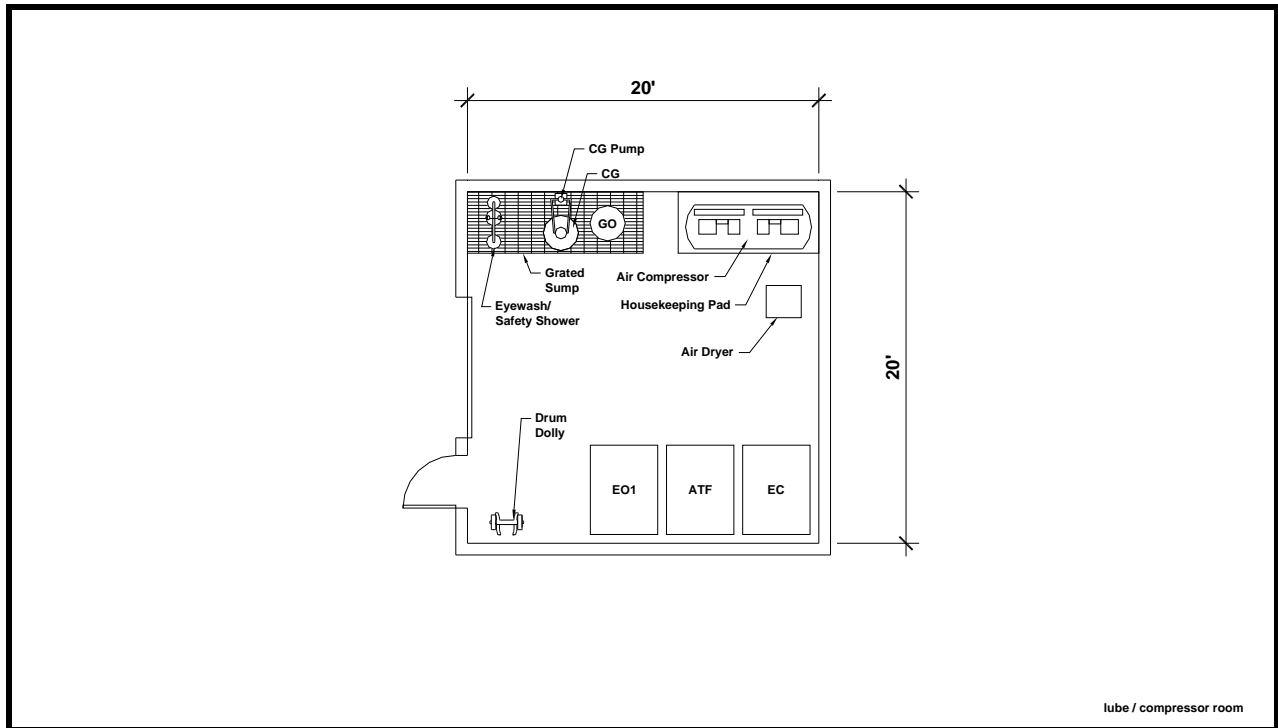

## FUNCTIONAL CHARACTERISTICS

### Function

- Enclosed room for storage and distribution of lubricants to the facility, including automatic transmission fluid (ATF), engine coolant (EC), engine oil (EO), and gear oil (GO).
- Space for air compressor, receiver, air dryer, and full and empty drums.

### Relationship to Other Areas

- Centrally located to minimize piping runs.

### Critical Dimensions

- 12'-0" vertical clearance.

### Equipment/Furnishings

- Duplex, reciprocating air compressor, air dryer, double wall above ground fluid storage tanks (ATF, EC, and EO), air piston and diaphragm pumps.
- GO stored in 55 gallon drums.
- Storage tanks at 500 gallons each.

### Comments

- Acoustically and physically separated from personnel areas to prevent migration of noise, dirt, and fumes.
- Provide for easy cleaning below grating.



# FUNCTIONAL REQUIREMENTS

---

## TECHNICAL CONSIDERATIONS

### Architectural

- Finishes
  - Floor: Soil, grease, and water resistant concrete, with integral non-metallic hardener, and clear epoxy sealer. Provide slip resistant finish.
  - Walls: Soil and grease resistant. Epoxy painted to 8 feet AFF.
  - Ceiling: Painted exposed structure.
- Doors
  - Exterior overhead door: 10' x 10' motor operated with interior push button controls, and lockout on exterior.
  - Personnel doors to meet applicable codes and exiting requirements.

### Structural

- Control joints in floor slab at adequate spacing.
- Structure as needed to support equipment.
- Raised concrete housekeeping pad under compressors and air dryers.
- Containment sumps (below storage drums) covered with grating.

### Mechanical

- General ventilation as required by codes.
- As required by equipment.

### Plumbing

- 3/4" water hose bib with standard faucet at 4'-0" AFF.
- Compressed air line with cut-off valve, separator, regulator with gauge, lubricator, cleanout valve, and quick disconnects on wall at 4'-0" AFF for each lubricant pump.
- Grated area (below drums and with drain) to sediment and oil interceptor.
- Wall mount the engine coolant diaphragm pump and all lubricant pumps, except above ground fluid storage tank pumps (tank mounted).
- Provide siphon kit for wall mounted pumps.
- As required by equipment.

### Electrical

- Lighting
  - Fluorescent. Refer to Chapter 4 for foot candle lighting requirements.
- Power
  - General purpose duplex receptacles, 120VAC, 20A, GFI protected, on walls at 3'-6" AFF.
  - As required by equipment.
- Communications
  - Paging/intercom system speakers.

# FUNCTIONAL REQUIREMENTS

---

## Portable Equipment Storage

*(Maintenance – Bays & Shops)*

### Function

- Secure area for the storage of portable shop equipment.

### Relationship to Other Areas

- Adjacent to General Repair Bays.

### Comments/Characteristics

- Furnishings: None.
- Utility requirements: Grounded electrical convenience outlets and heated.
- Floor: Soil, grease, and water resistant concrete, with integral non-metallic hardener, and clear epoxy sealer. Provide white slip resistant finish.
- Wall Finishes: Epoxy painted concrete block.
- Ceiling Finishes: Painted exposed structure.
- Lighting: Fluorescent. Refer to chapter 4 for foot candle requirements.

# FUNCTIONAL REQUIREMENTS

---

## **Tool Box Storage**

*(Maintenance – Bays & Shops)*

### Function

- Area for the storage of mechanic tool boxes.

### Relationship to Other Areas

- Adjacent to General Repair Bays.

### Comments/Characteristics

- Furnishings: None.
- Utility requirements: Grounded electrical convenience outlets and heated.
- Floor: Soil, grease, and water resistant concrete, with integral non-metallic hardener, and clear epoxy sealer. Provide white slip resistant finish.
- Wall Finishes: Epoxy painted concrete block.
- Ceiling Finishes: Painted exposed structure.
- Lighting: Fluorescent. Refer to chapter 4 for foot candle requirements.

# FUNCTIONAL REQUIREMENTS

---

## MATERIALS MANAGEMENT- PARTS STOREROOM

### FUNCTIONAL RELATIONSHIP DIAGRAM

The relationships between the various functional areas within this section are shown below. The design should accommodate these relationships in order to maximize operational efficiency. This diagram is not meant to be a floor plan, and serves only as a representational relationship diagram.

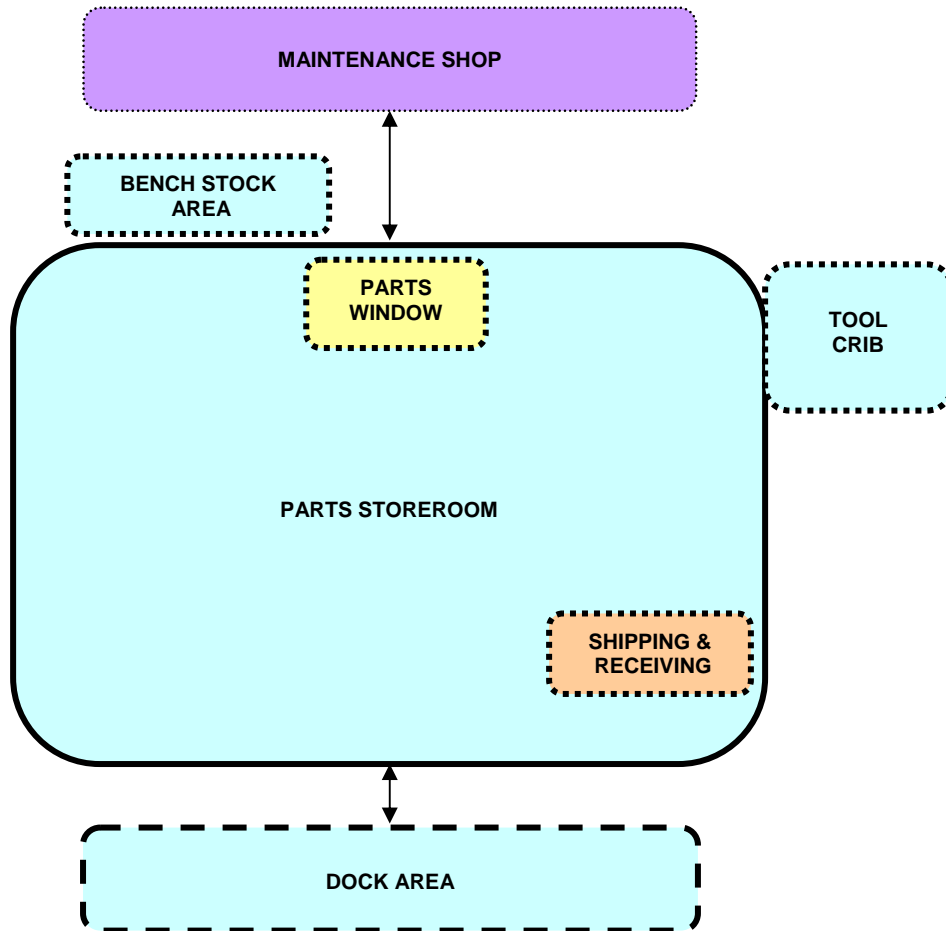

### FUNCTIONAL AREA MODULES

Each functional area within this section has been individually defined as a module. Each module has information regarding the function of the space, relationships to other areas and other information received during interviews with ABQ Ride staff.

# FUNCTIONAL REQUIREMENTS

## Parts Office

(Materials Management)

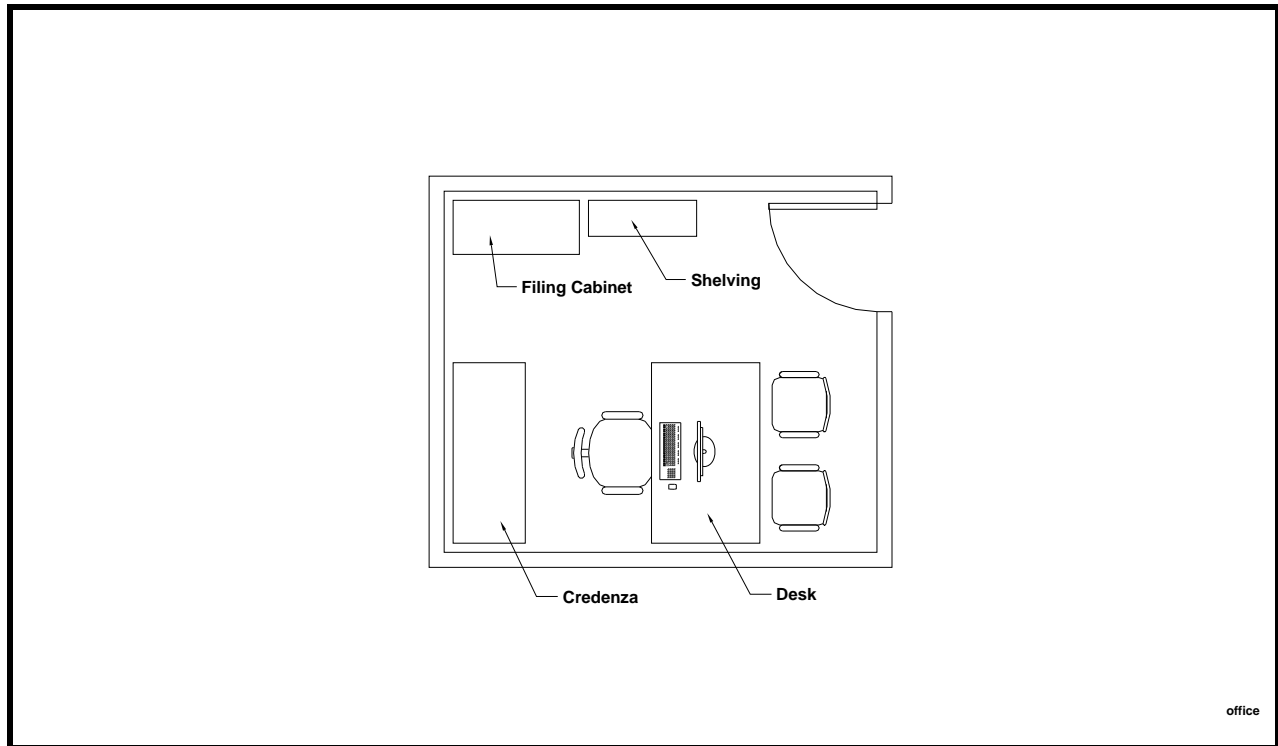

### Function

- Enclosed private office for Parts staff.

### Relationship to Other Areas

- Adjacent to Parts Storage.
- Near Material Manager's Office.

### Comments/Characteristics

- Furnishings: Desk, chair, shelving, file drawer, phone, computer, and printer.
- Utility Requirements: Grounded electrical convenience outlets, telephone, intercom/paging system, conduit for network computer system, air conditioned, and heated.
- Floor Finishes: Carpet.
- Wall Finishes: Painted gypsum board.
- Ceiling Finishes: Acoustical tile ceiling.
- Lighting: Office light fixture. Refer to chapter 4 for foot candle and fixture requirements.

# FUNCTIONAL REQUIREMENTS

## Parts Storeroom

(Materials Management)

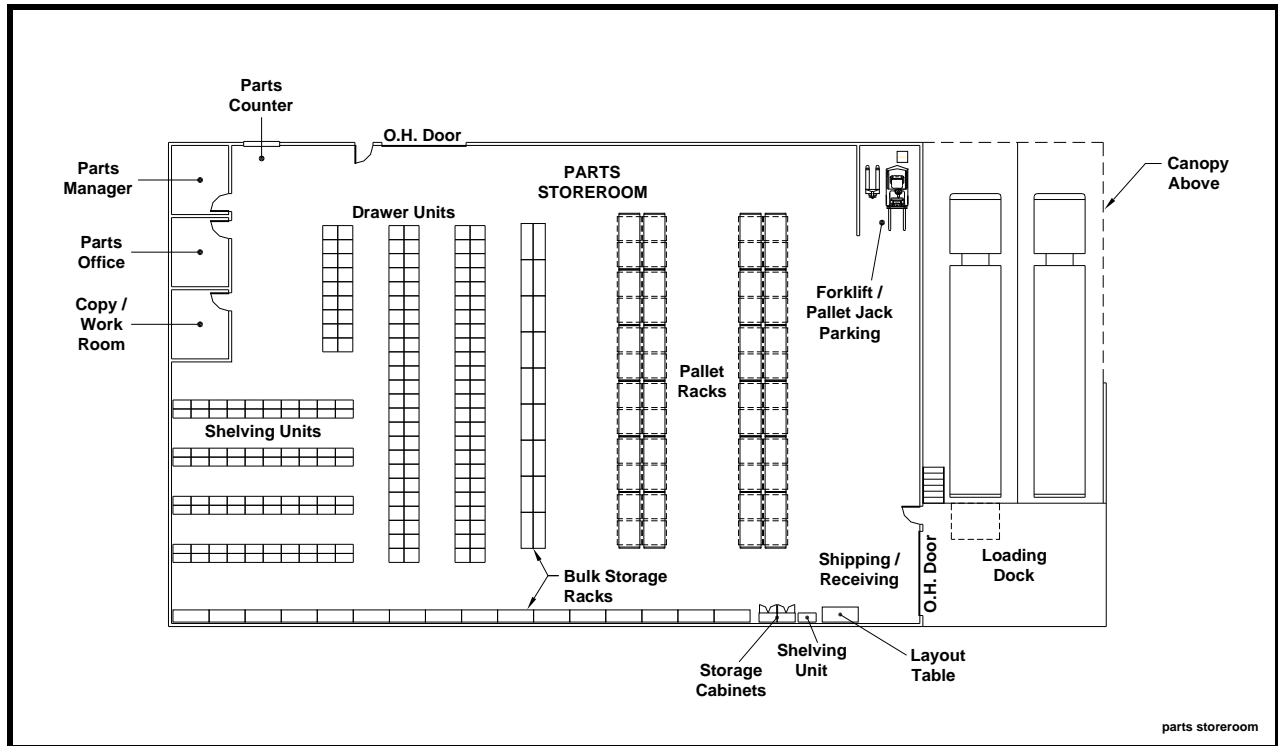

## FUNCTIONAL CHARACTERISTICS

### Function

- Designated secure area for storing and issuing of parts and materials.

### Relationship to Other Areas

- Adjacent to Parts Window, Bench Stock Area, and Shipping & Receiving.

### Critical Dimensions

- 19'-0" vertical clear.

### Equipment / Furnishings

- Bulk storage racks, shelving units, storage cabinets, pallet racks, bin units, forklift, and pallet jack.

### Comments

- Forklift accessible.
- Exterior access.
- Card access control.
- Consideration should be given to utilizing a high density pallet storage system.

# FUNCTIONAL REQUIREMENTS

---

## TECHNICAL CONSIDERATIONS

### Architectural

- Finishes
  - Floor: Soil, grease, and water resistant concrete, with integral non-metallic hardener, and clear epoxy sealer. Provide white slip resistant finish.
  - Walls: Soil and grease resistant. Epoxy painted to 8'-0" AFF.
  - Ceiling: Painted exposed structure.
- Doors
  - Personnel doors to meet applicable codes and exiting requirements.
  - Exterior overhead door: 10' x 10' motor operated with interior push button controls, and lockout on exterior.
- Bollards on interior and exterior jambs of overhead door (4 per door).

### Structural

- Control joints in floor slab at adequate spacing.
- Structure as needed to support equipment.

### Mechanical

- General ventilation as required by codes.
- As required by equipment.

### Plumbing

- 24" wide trench drain just inside overhead door with removable grating to oil/water separator.
- 3/4" water hose bib with standard faucet at 3'-6" AFF.
- Compressed air line with cut-off valve, filter, and regulator with gauge, lubricator, and quick disconnects on walls at 3'-6" AFF. Provide disconnects at locations to be determined during detailed design.
- As required by equipment.

### Electrical

- Lighting
  - High Bay Fixture. Refer to Chapter 4 for foot candle lighting requirements.
- Power
  - General purpose duplex receptacles, 120VAC, 20A, GFI protected, on walls and columns at 3'-6" AFF.
  - As required by equipment.
- Communications
  - Paging/intercom system speakers.

# FUNCTIONAL REQUIREMENTS

---

## Parts Issue Window

*(Materials Management)*

### Function

- Computer for the ordering and distribution of parts and materials.

### Relationship to Other Areas

- Adjacent to Parts Storeroom.

### Comments/Characteristics

- Furnishings: Counter with drawer cabinet pedestals, 2 stools, desk, chair, 20 LF of shelving, 2 file drawers, bulletin boards, phone and printer.
- Utility requirements: Grounded electrical convenience outlets, telephone, intercom/paging system, conduit for network computer system, air conditioned, and heated.
- Floor Finishes: Soil, grease, and water resistant concrete, with clear epoxy sealer.
- Wall Finishes: Soil and grease resistant. Epoxy painted to 8 feet AFF.
- Ceiling Finishes: Painted exposed structure.
- Lighting: High bay fixture. Refer to chapter 4 for foot candle requirements.
- Counter to have sliding glass partition.

## Shipping & Receiving

*(Materials Management)*

### Function

- Designated area within the Parts Storeroom for staging and unpacking received parts and parts waiting to be shipped.

### Relationship to Other Areas

- Within Parts Storeroom.

### Critical Dimensions

- 19'-0" vertical clear.

### Comments/Characteristics

- Furnishings: Receiving table, unpacking table, shelving unit, loading dock, and pallet racks.
- Utility Requirements: Grounded electrical convenience outlets, telephone, and intercom/paging system conduit for network computers, ventilated and heated.
- Floor Finishes: Soil, grease, and water resistant concrete, with clear epoxy sealer. Provide slip resistant finish.
- Wall Finishes: Soil and grease resistant. Epoxy painted to 8 feet AFF.
- Ceiling Finishes: Painted exposed structure.
- Lighting: High bay fixture. Refer to chapter 4 for foot candle requirements.



# FUNCTIONAL REQUIREMENTS

## Dock Area

(Materials Management)

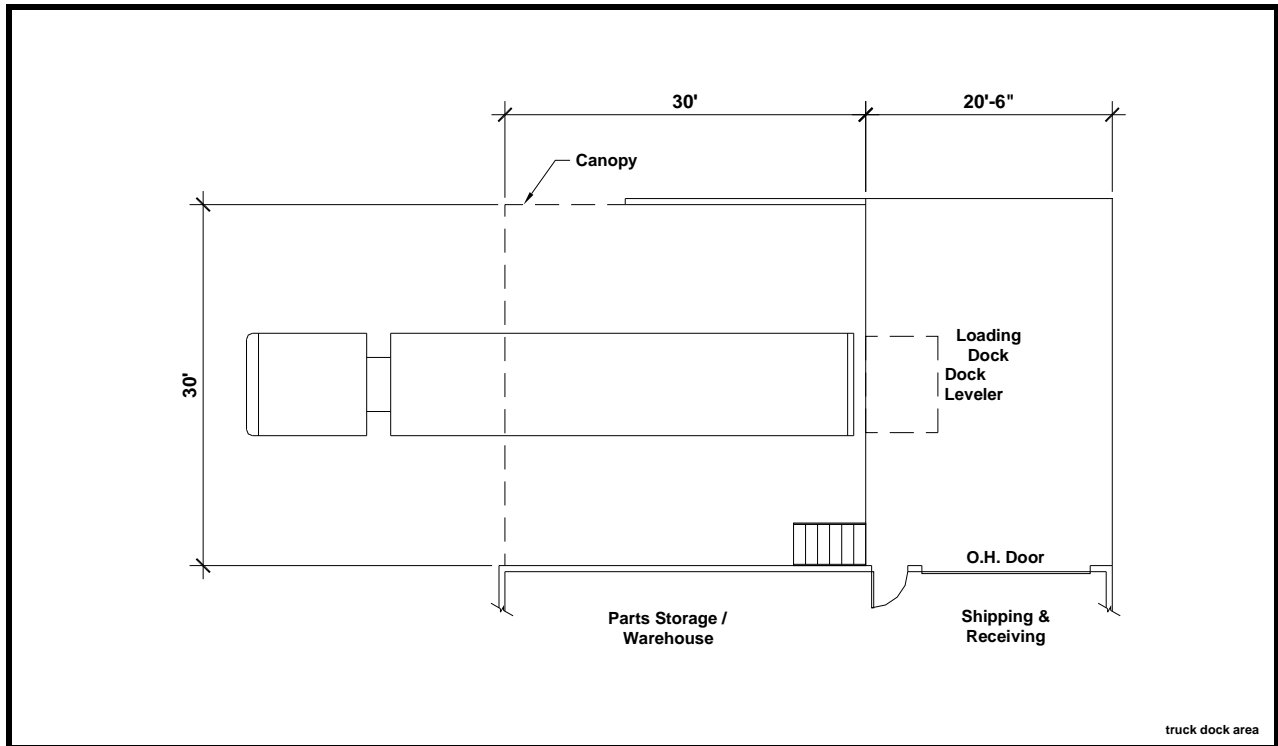

### Function

- Canopy covered area for loading / unloading trucks.

### Relationship to Other Areas

- Adjacent to Shipping & Receiving.

### Comments/Characteristics

- Furnishings: Dock leveler, dock lock, and leveler controls.
- Utility Requirements: Grounded electrical convenience outlets (waterproof).
- Floor Finishes: None.
- Wall Finishes: Epoxy painted concrete block.
- Ceiling Finishes: Painted exposed structure.
- Lighting: High bay fixture. Refer to Chapter 4 for foot candle lighting requirements.
- Canopy over back of trucks.
- Forklift Grading.

# FUNCTIONAL REQUIREMENTS

---

## Tool Crib

**(Materials Management)**

### Function

- Enclosed secure area for the storage of maintenance tools and equipment.

### Relationship to Other Areas

- Adjacent to Parts Storeroom.
- Near repair bays and shops.

### Comments/Characteristics

- Furnishings: Shelving units, storage cabinets, and shadow boards.
- Utility requirements: Grounded electrical convenience outlets and heated.
- Floor Finishes: Soil, grease, and water resistant concrete, with clear epoxy sealer.
- Wall Finishes: Chain link fence.
- Ceiling Finishes: Painted exposed structure.
- Lighting: High bay fluorescent. Refer to Chapter 4 for foot candle lighting requirements.

## Bench Stock Area (nuts and bolts)

**(Materials Management)**

### Function

- Bench stock outside of parts storage racks in bins near counter to allow parts access to mechanics without accessing secure parts storage.

### Relationship to Other Areas

- Near and outside of Parts Window.
- Near Maintenance Bays.

### Comments/Characteristics

- Furnishings: Bins and shelving.
- Utility requirements: Grounded electrical convenience outlets, telephone, intercom/paging system, conduit for network computer system, air conditioned, and heated.
- Floor Finishes: Soil, grease, and water resistant concrete, with clear epoxy sealer.
- Wall Finishes: Soil and grease resistant. Epoxy painted to 8 feet AFF.
- Ceiling Finishes: Painted exposed structure.
- Lighting: High bay fixture. Refer to chapter 4 for foot candle requirements.

# FUNCTIONAL REQUIREMENTS

## FUEL / WASH

### FUNCTIONAL RELATIONSHIPS

The relationships between the various functional areas within this section are shown below. The design should accommodate these relationships in order to maximize operational efficiency. This diagram is not meant to be a floor plan, only a representational relationship diagram.

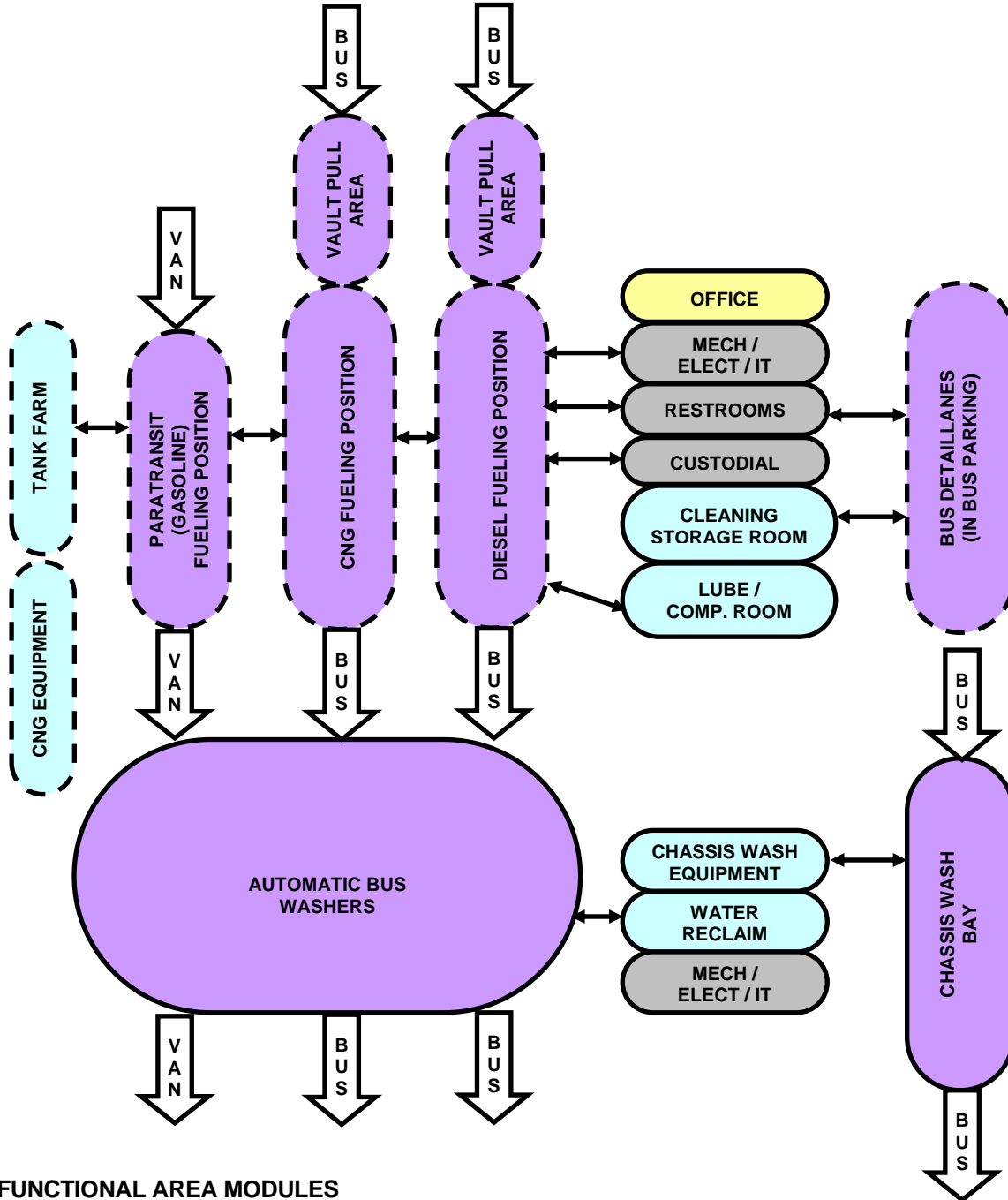

### FUNCTIONAL AREA MODULES

Each functional area within this section has been individually defined as a module. Each module has information regarding the function of the space, relationships to other areas, critical dimensions (if any), equipment/furnishings, and finishes. Technical considerations for ventilation, mechanical, plumbing, and electrical are also defined. The Equipment List takes precedence over equipment shown in modules.

# FUNCTIONAL REQUIREMENTS

Diesel / CNG Fuel Position (Standard & Artic)

(Fuel)

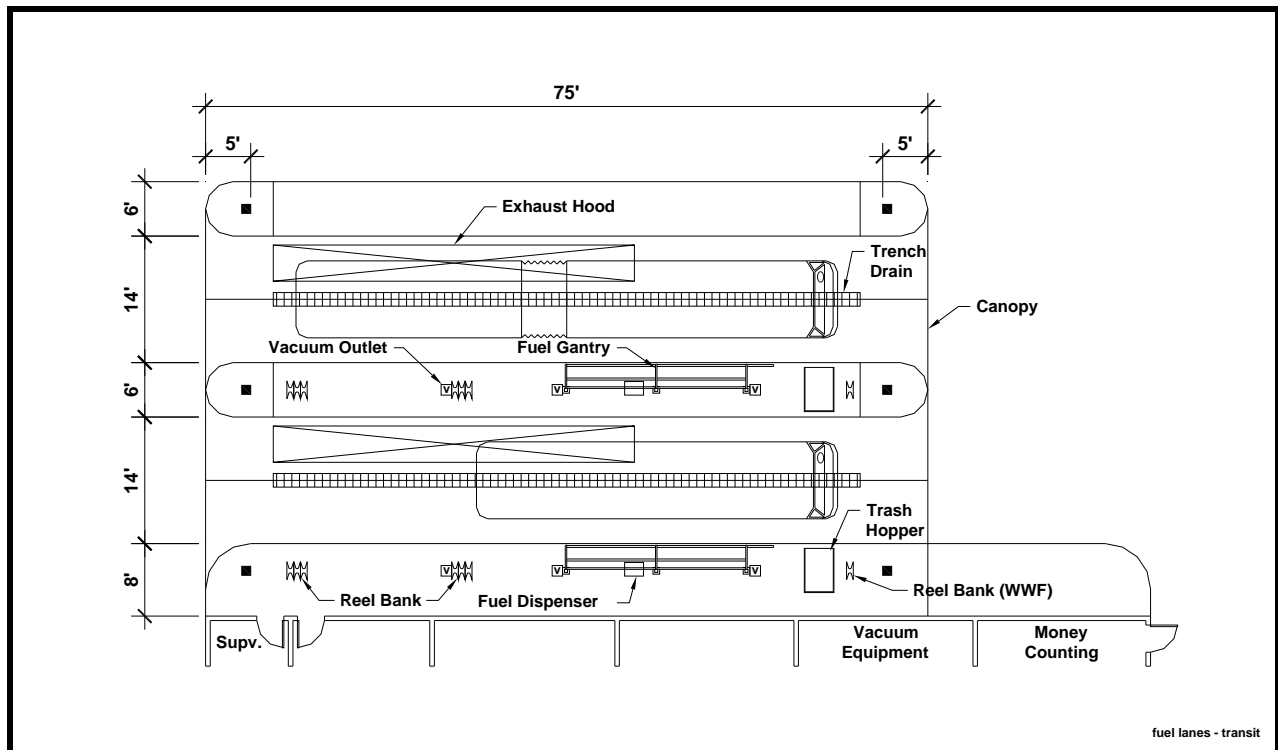

## FUNCTIONAL CHARACTERISTICS

### Function

- Canopy covered drive-thru lanes for fueling of buses and non-revenue vehicles as needed.
- Sweep out area for buses with paper recycling bins.

### Relationship to Other Areas

- Convenient access to / from vehicle parking.
- Efficiently located within site traffic flow.

### Critical Dimensions

- 16'-0" vertical clearance to roof structure.
- 20'-0" wide by 75'-0" long.

### Equipment/Furnishings

- Dual hose diesel dispenser (posi-lock nozzle), fuel management system with RFID readers, shop desk, trash hopper, paper recycle bins, vacuum system outlets, utility wash sink, emergency safety shower / eyewash, fuel hose gantry, reel banks with, ATF, EC, EO, and WWF, and exhaust hood.

### Comments/Characteristics

- Forklift access.
- Drive-thru configuration.

# FUNCTIONAL REQUIREMENTS

---

## TECHNICAL CONSIDERATIONS

### Architectural

- Finishes
  - Floor: Soil, grease, and water resistant concrete, with integral non-metallic hardener, and clear epoxy sealer. Provide white slip resistant finish.
  - Walls: Soil and grease resistant. Epoxy painted to 8'-0" AFF.
  - Ceiling: Painted exposed roof structure in lanes.
- Doors
  - None.
  - Bollards as necessary to protect structure.

### Structural

- Sealed control joints in floor slab at adequate spacing.
- Structure as needed to support equipment.

### Mechanical

- Ventilation as required by codes to prevent accumulation of explosive mixtures.
- General ventilation as required by codes.
- As required by equipment.
- Provide exhaust hood over location of bus exhaust stack when bus is in fuel position.
- All rooms that open to fuel lanes must have positive pressure.

### Plumbing

- 24" trench drain at center of bus position with removable grating to oil/water separator.
- 3/4" water hose bib with freeze proof faucet, one per fuel position.
- Product and vapor recovery piping as required to and from fuel tanks and dispensers.
- Lube reel banks with, ATF, EO1, EO2 and EC at rear of vehicle position, 1 for Articulated and 1 for Standard Transit Coaches. Lube reel with WWF at front of vehicle position
- Compressed air line with cut-off valve, filter, regulator with gauge, lubricator, clean out valve, and quick disconnects at 3'-6" AFF.

### Electrical

- Lighting
  - Waterproof high bay fluorescent.
- Power
  - General-purpose duplex receptacles, 120 VAC, 20A, GFI protected, on walls at 3'-6" AFF.
  - As required by equipment.
  - Fueling (pumps, dispensers, lights) to be on emergency circuits.
  - Fuel pumps to have emergency shut-off in the area.
- Communications
  - Paging/intercom system speakers.
  - Conduit for network computer system.
- Fuel Management System
  - Provide power and signal conduit from island terminals to system controller.

# FUNCTIONAL REQUIREMENTS

Diesel / Gasoline Fuel Position (Standard & Artic)

(Fuel)

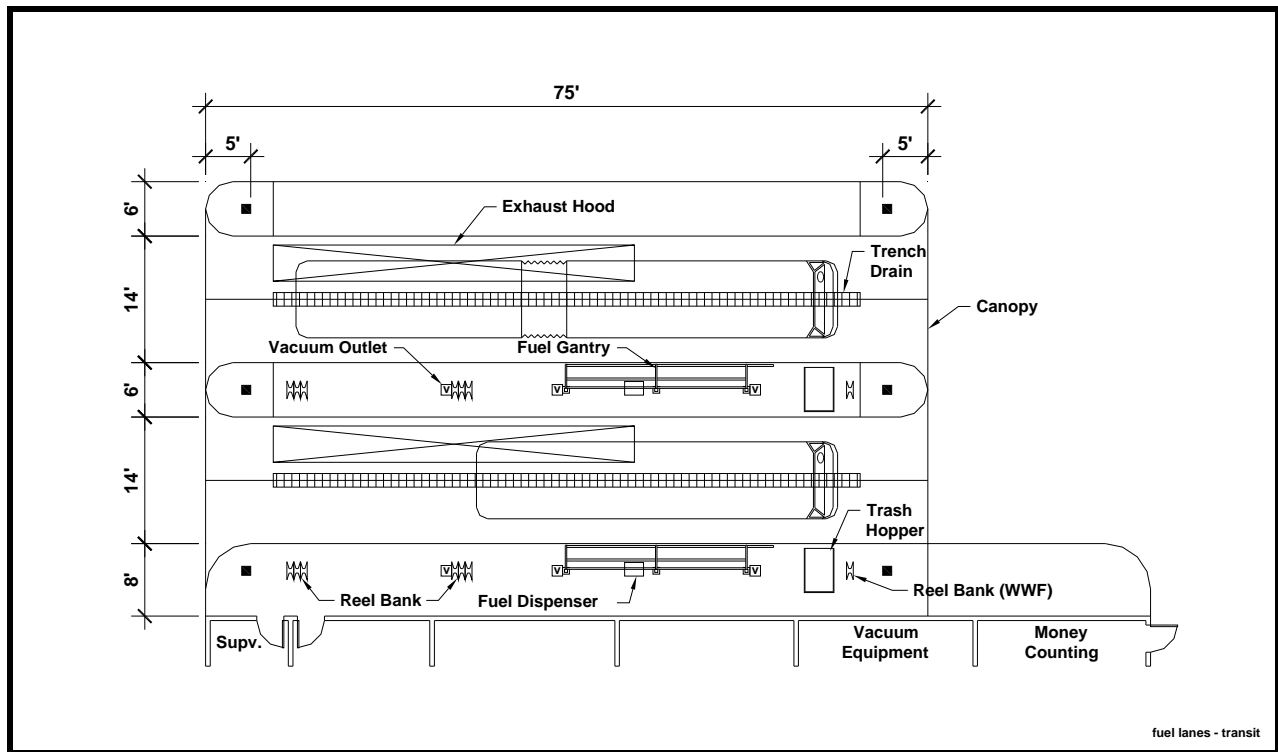

## FUNCTIONAL CHARACTERISTICS

### Function

- Canopy covered drive-thru lanes for fueling of buses and non-revenue vehicles as needed.
- Sweep out area for buses with paper recycling bins.

### Relationship to Other Areas

- Convenient access to / from vehicle parking.
- Efficiently located within site traffic flow.

### Critical Dimensions

- 16'-0" vertical clearance to roof structure.
- 20'-0" wide by 75'-0" long.

### Equipment/Furnishings

- Dual hose diesel dispenser (posi-lock nozzle), fuel management system with RFID readers, shop desk, trash hopper, paper recycle bins, vacuum system outlets, utility wash sink, emergency safety shower / eyewash, fuel hose gantry, reel banks with, ATF, EC, EO, and WWF, and exhaust hood.

### Comments/Characteristics

- Forklift access.
- Drive-thru configuration.

# FUNCTIONAL REQUIREMENTS

---

## TECHNICAL CONSIDERATIONS

### Architectural

- Finishes
  - Floor: Soil, grease, and water resistant concrete, with integral non-metallic hardener, and clear epoxy sealer. Provide white slip resistant finish.
  - Walls: Soil and grease resistant. Epoxy painted to 8'-0" AFF.
  - Ceiling: Painted exposed roof structure in lanes.
- Doors
  - None.
  - Bollards as necessary to protect structure

### Structural

- Sealed control joints in floor slab at adequate spacing.
- Structure as needed to support equipment.

### Mechanical

- Ventilation as required by codes to prevent accumulation of explosive mixtures.
- General ventilation as required by codes.
- As required by equipment.
- Provide exhaust hood over location of bus exhaust stack when bus is in fuel position.
- All rooms that open to fuel lanes must have positive pressure.

### Plumbing

- 24" trench drain at center of bus position with removable grating to oil/water separator.
- 3/4" water hose bib with freeze proof faucet, one per fuel position.
- Product and vapor recovery piping as required to and from fuel tanks and dispensers.
- Lube reel banks with, ATF, EO1, EO2 and EC at rear of vehicle position, 1 for Articulated and 1 for Standard Transit Coaches. Lube reel with WWF at front of vehicle position
- Compressed air line with cut-off valve, filter, regulator with gauge, lubricator, clean out valve, and quick disconnects at 3'-6" AFF.

### Electrical

- Lighting
  - Waterproof high bay fluorescent.
- Power
  - General-purpose duplex receptacles, 120 VAC, 20A, GFI protected, on walls at 3'-6" AFF.
  - As required by equipment.
  - Fueling (pumps, dispensers, lights) to be on emergency circuits.
  - Fuel pumps to have emergency shut-off in the area.
- Communications
  - Paging/intercom system speakers.
  - Conduit for network computer system.
- Fuel Management System
  - Provide power and signal conduit from island terminals to system controller.

# FUNCTIONAL REQUIREMENTS

---

## CNG Compressor Station Equipment

*(Fuel)*

### Function

- Designated space for electrical building support equipment.

### Relationship to Other Areas

- Adjacent to Fuel Tanks.

### Comments/Characteristics

- Furnishings: CNG Fueling Equipment.
- Utility requirements: As required by equipment.
- Floor Finishes: Exposed concrete.
- Wall Finishes: Epoxy painted concrete block.
- Ceiling Finishes: None.
- Lighting: Site lighting fixture. Refer to chapter 4 for foot candle and fixture requirements.



# FUNCTIONAL REQUIREMENTS

## Service Supervisor

(Fuel)

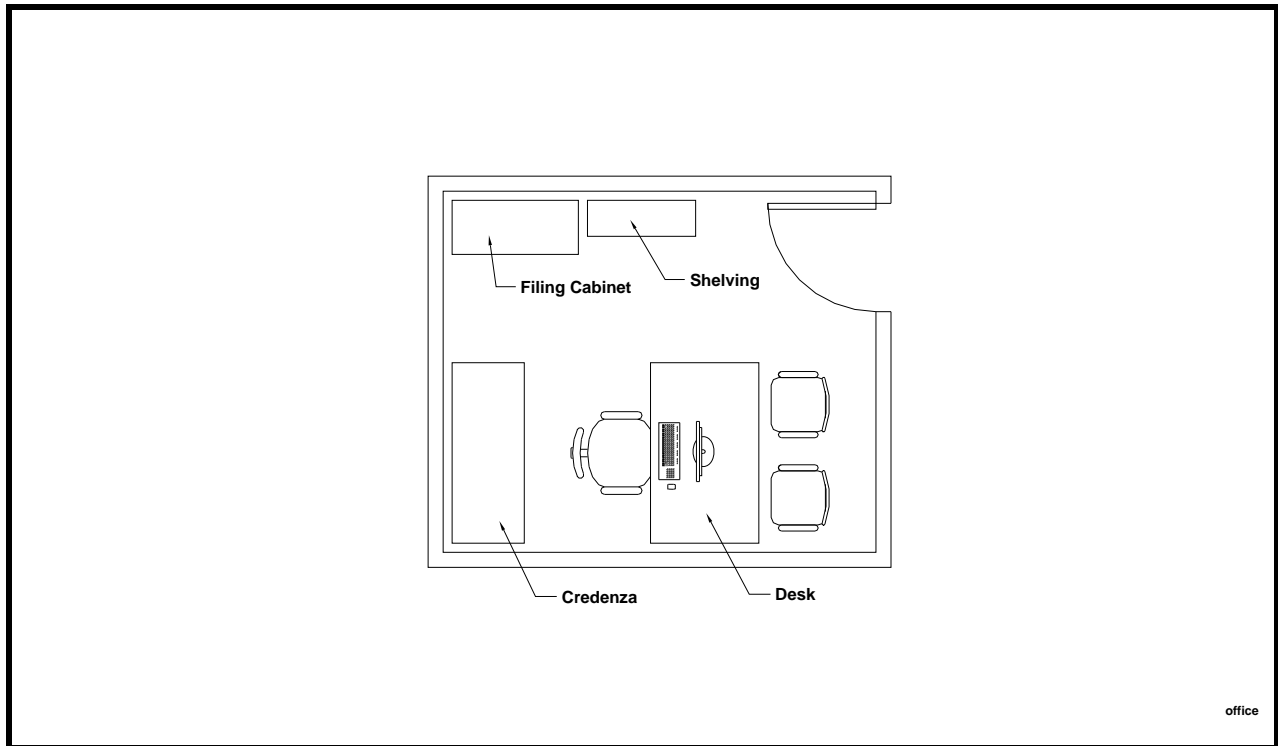

### Function

- Enclosed private office for the Service Supervisor.

### Relationship to Other Areas

- Adjacent to Fuel Lanes.

### Comments/Characteristics

- Furnishings: Desk, chair, shelving, file drawer, phone, computer, and printer.
- Utility Requirements: Grounded electrical convenience outlets, telephone, intercom/paging system, conduit for network computer system, air conditioned, and heated.
- Floor Finishes: Carpet.
- Wall Finishes: Painted gypsum board.
- Ceiling Finishes: Acoustical tile ceiling.
- Lighting: Office light fixture. Refer to chapter 4 for foot candle and fixture requirements.

# FUNCTIONAL REQUIREMENTS

---

## Men's Restroom

(Fuel)

### Function

- Male restroom facility for male service staff.

### Relationship to Other Areas

- Adjacent to Fuel Lanes.

### Comments/Characteristics

- **Furnishings:** Provide toilet with auto flush valve, floor drain with trap primer, both paper towel and automatic motion sensing air dryer, automatic soap dispensing unit, and other fixtures as required by code.
- **Utility Requirements:** Grounded electrical convenience outlets, telephone, air conditioned, and heated, water, drain.
- **Floor Finishes:** Resilient flooring.
- **Wall Finishes:** Painted gypsum board with porcelain tile on gypsum board and wet areas.
- **Ceiling Finishes:** Acoustical tile ceiling.
- **Lighting:** Fluorescent. Refer to chapter 4 for foot candle requirements.

## Women's Restroom

(Fuel)

### Function

- Female restroom facility for female service staff.

### Relationship to Other Areas

- Adjacent to Fuel Lanes.

### Comments/Characteristics

- **Furnishings:** Provide toilet with auto flush valve, floor drain with trap primer, both paper towel and automatic motion sensing air dryer, automatic soap dispensing unit, and other fixtures as required by code.
- **Utility Requirements:** Grounded electrical convenience outlets, telephone, air conditioned, and heated, water, drain.
- **Floor Finishes:** Resilient flooring.
- **Wall Finishes:** Painted gypsum board with porcelain tile on gypsum board and wet areas.
- **Ceiling Finishes:** Acoustical tile ceiling.
- **Lighting:** Fluorescent. Refer to chapter 4 for foot candle requirements.

# FUNCTIONAL REQUIREMENTS

---

## **Cleaning Supply Room**

*(Fuel)*

### Function

- Enclosed area for storage of cleaning supplies and cleaning equipment.

### Relationship to Other Areas

- Adjacent to Fuel Lanes.

### Comments/Characteristics

- Furnishings: Shelving unit.
- Utility Requirements: Grounded electrical convenience outlets, ventilated, and heated.
- Floor Finishes: Sealed concrete.
- Wall Finishes: Painted gypsum board.
- Ceiling Finishes: Acoustical tile ceiling or painted exposed structure.
- Lighting: Fluorescent. Refer to chapter 4 for foot candle requirements.

## **Money Counting Room**

*(Fuel)*

### Function

- Enclosed securable room for vault receiver and vault cart storage.

### Relationship to Other Areas

- Adjacent to Fuel Lanes.

### Comments/Characteristics

- Furnishings: 2 vault receivers, 5 vault carts, 3048 mm (10 LF) counter / work surface, computer, printer, chair, phone.
- Utility Requirements: Grounded electrical convenience outlets and on wall above countertop telephone, intercom/paging system, conduit for network computer system, air conditioned, and heated, provide air curtain at both man door and overhead door.
- Floor Finishes: Sealed concrete.
- Wall Finishes: Painted gypsum board.
- Ceiling Finishes: Acoustical tile ceiling.
- Lighting: Fluorescent. Refer to Chapter 4 for foot candle lighting requirements.

# FUNCTIONAL REQUIREMENTS

## Lube/Compressor Room

(Fuel)

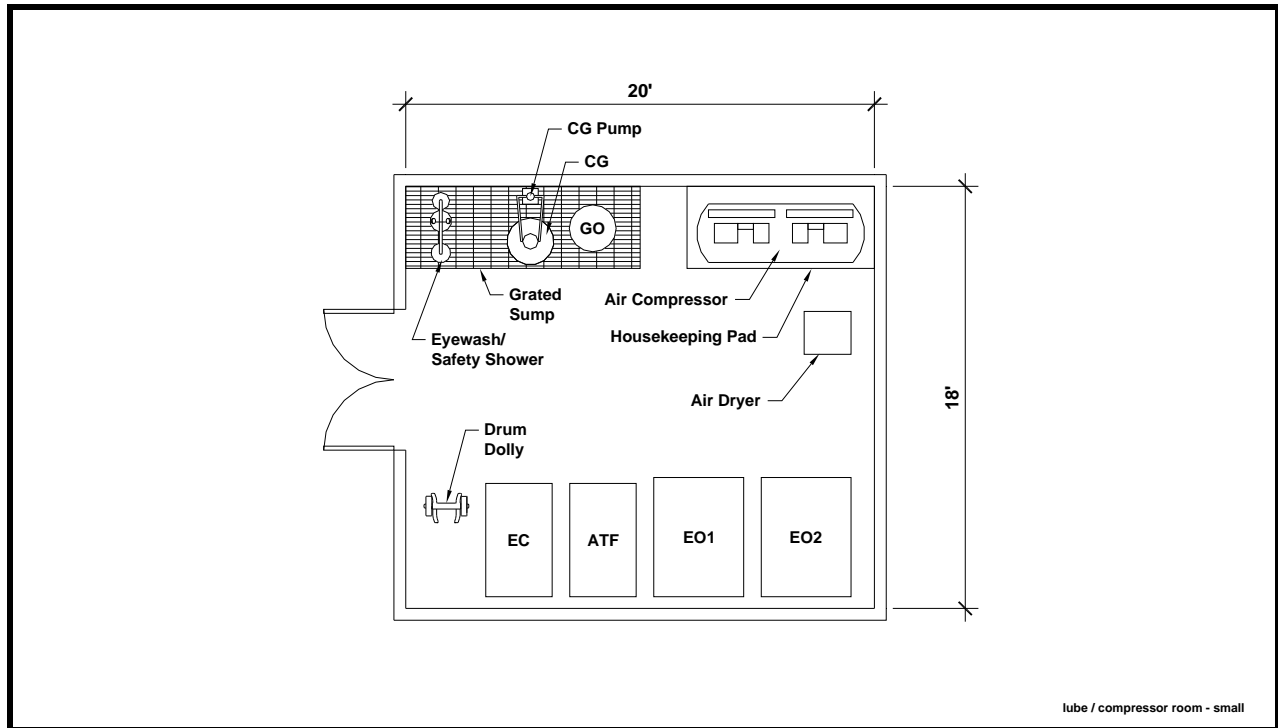

### FUNCTIONAL CHARACTERISTICS

#### Function

- Enclosed room for storage and distribution of lubricants to the facility, including automatic transmission fluid (ATF), engine coolant (EC), engine oil (EO), and gear oil (GO).
- Space for air compressor, receiver, air dryer, and full and empty drums.

#### Relationship to Other Areas

- Centrally located to minimize piping runs.

#### Critical Dimensions

- 12'-0" vertical clearance.

#### Equipment/Furnishings

- Duplex, reciprocating air compressor, air dryer, double wall above ground fluid storage tanks (ATF, EC, and EO), air piston and diaphragm pumps.
- GO stored in 55 gallon drums.

#### Comments

- Acoustically and physically separated from personnel areas to prevent migration of noise, dirt, and fumes.
- Provide for easy cleaning below grating.

# FUNCTIONAL REQUIREMENTS

---

## TECHNICAL CONSIDERATIONS

### Architectural

- Finishes
  - Floor: Soil, grease, and water resistant concrete, with integral non-metallic hardener, and clear epoxy sealer. Provide slip resistant finish.
  - Walls: Soil and grease resistant. Epoxy painted to 8 feet AFF.
  - Ceiling: Painted exposed structure.
- Doors
  - Double 3'-0" wide hollow metal door with interior exit device.

### Structural

- Control joints in floor slab at adequate spacing.
- Structure as needed to support equipment.
- Raised concrete housekeeping pad under compressors and air dryers.
- Containment sumps (below storage drums) covered with grating.

### Mechanical

- General ventilation as required by codes.
- As required by equipment.

### Plumbing

- 3/4" water hose bib with standard faucet at 4'-0" AFF.
- Compressed air line with cut-off valve, separator, regulator with gauge, lubricator, cleanout valve, and quick disconnects on wall at 4'-0" AFF for each lubricant pump.
- Grated area (below drums and with drain) to sediment and oil interceptor.
- Wall mount the engine coolant diaphragm pump and all lubricant pumps, except above ground fluid storage tank pumps (tank mounted).
- Provide siphon kit for wall mounted pumps.
- As required by equipment.

### Electrical

- Lighting
  - Fluorescent. Refer to Chapter 4 for foot candle lighting requirements.
- Power
  - General purpose duplex receptacles, 120VAC, 20A, GFI protected, on walls at 3'-6" AFF.
  - As required by equipment.
- Communications
  - Paging/intercom system speakers.

# FUNCTIONAL REQUIREMENTS

## Automatic Bus Washer / Water Reclaim / Wash Equipment Room

(Wash)

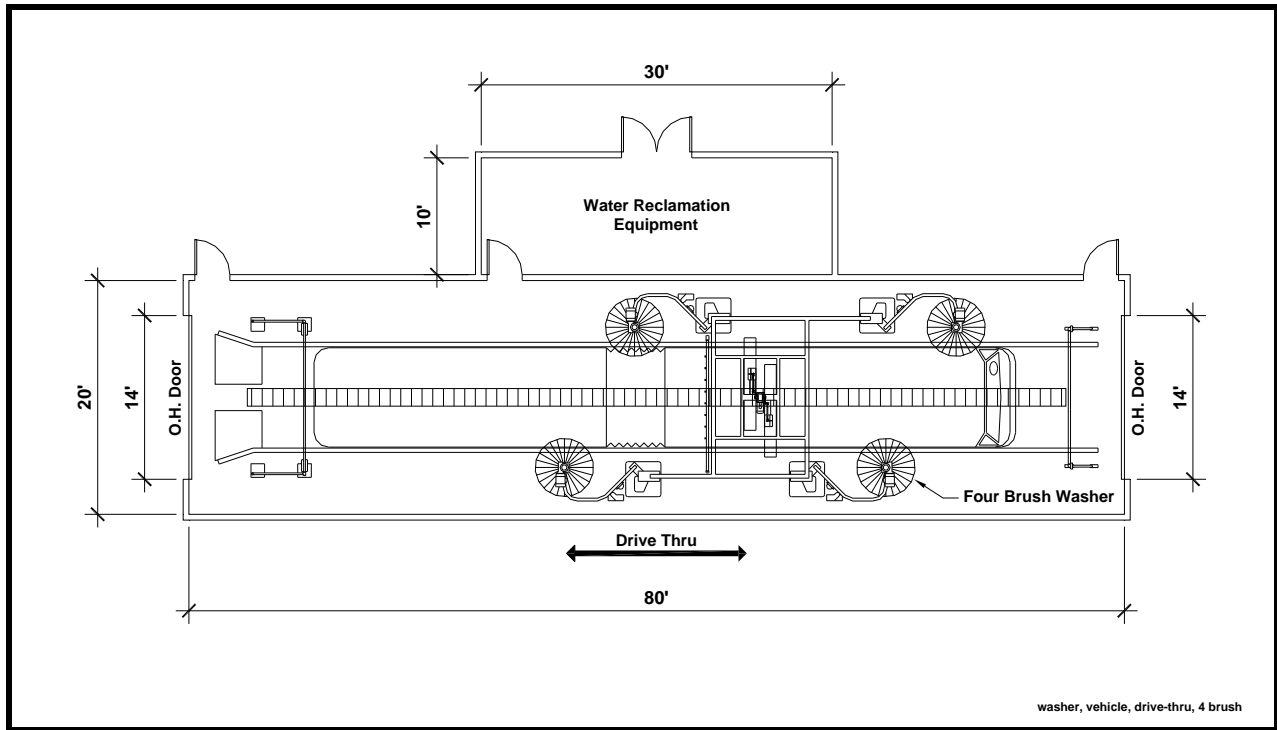

### FUNCTIONAL CHARACTERISTICS

#### Function

- Enclosed drive-thru area for the automatic cleaning of vehicle exteriors. Washer shall be capable of washing all transit vehicles including paratransit vans.

#### Relationship to Other Areas

- Immediately following traffic flow through fueling lanes.
- Must be separated from fueling lanes to allow buses to fuel and by-pass wash, by-pass fuel and then wash, or by-pass both fuel and wash.

#### Critical Dimensions

- 16'-0" vertical clearance to canopy.

#### Equipment/Furnishings

- Four brush drive-through wash system.

#### Comments

- Provide appropriate drainage to recover water runoff from top of bus exiting the washer.

# FUNCTIONAL REQUIREMENTS

---

## TECHNICAL CONSIDERATIONS

### Architectural

- Finishes
  - Floor: Air entrained concrete. Provide slip resistant finish.
  - Walls: Soil and grease resistant on exterior.
  - Ceiling: Painted exposed structure.
  - All exposed steel in area to be rust protected.
- Doors
  - Personnel doors to meet applicable codes and exiting requirements.
  - Exterior overhead door: 14' x 14' motor operated with interior push button controls, and lockout on exterior.
- Bollards on exterior at jambs of overhead door (2 per door).

### Structural

- Sealed control joints in slab at adequate spacing.
- Structure as needed to support equipment.

### Mechanical

- As required by equipment.

### Plumbing

- 24" trench drain with removable traffic rated grating to water + equipment (**1 each per lane**).
- As required by equipment.
- Overflow through oil / water separator and then on to sanitary sewer.

### Electrical

- Lighting
  - Waterproof high bay fluorescent Refer to Chapter 4 for foot candle lighting requirements.
- Power
  - As required by equipment.
- Communications
  - Paging/intercom system speakers.

# FUNCTIONAL REQUIREMENTS

## Chassis Wash (Standard Buses)

(Wash)

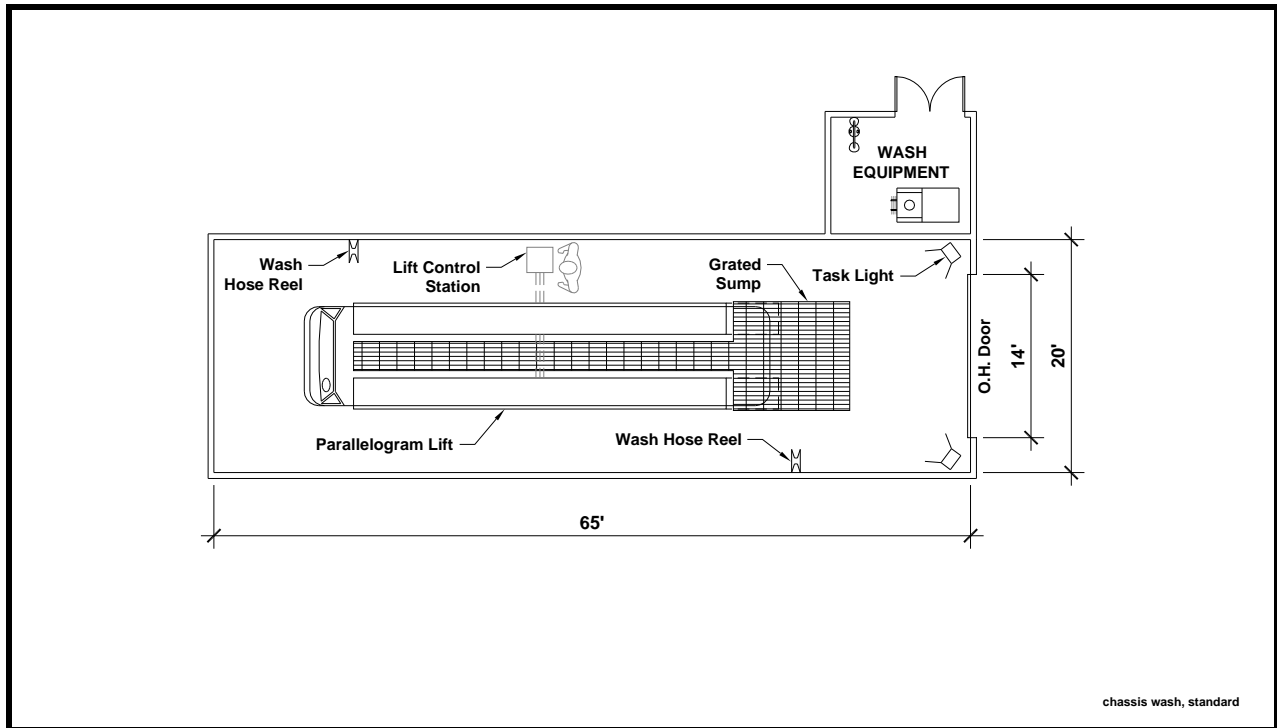

## FUNCTIONAL CHARACTERISTICS

### Function

- Enclosed bays for washing of standard bus undercarriages, engine compartments, and components.

### Relationship to Other Areas

- Adjacent to Vehicle Wash Bay.

### Critical Dimensions

- 19'-0" vertical clearance.
- 20'-0" wide by 65'-0" long.

### Equipment/Furnishings

- Parallelogram ramp type lift, high pressure/hot water washer, and eye wash/safety shower.

### Comments

- Forklift access.



# FUNCTIONAL REQUIREMENTS

---

## TECHNICAL CONSIDERATIONS

### Architectural

- Finishes
  - Floor: Soil, grease, and water resistant concrete, with integral non-metallic hardener, and clear epoxy sealer. Provide slip resistant finish.
  - Walls: Soil and grease resistant. Epoxy painted to 8 feet AFF.
  - Ceiling: Painted exposed structure.
- Doors
  - Personnel doors to meet applicable codes and exiting requirements.
  - Exterior overhead door: 14' x 14' motor operated with interior push button controls, and lockout on exterior. Designed to withstand wet area.
- Bollards on exterior at jambs of overhead door (2 per door).

### Structural

- Control joints in floor slab at adequate spacing.
- Structure as needed to support equipment.

### Mechanical

- Heating system must be compatible with use of alternative fueled vehicles.
- Ventilation as required by codes to prevent accumulation of explosive mixtures.
- General ventilation as required by codes.
- As required by equipment.
- Must have good ventilation.

### Plumbing

- 3/4" water hose bib with standard faucet at 4'-0" AFF.
- Compressed air line with cut-off valve, filter regulator with gauge, lubricator, cleanout valve, and quick disconnects on walls at 4'-0" AFF. Provide disconnects at locations to be determined during detailed design.
- Sump pit between lift ramps (with removable grated cover) with drain to sediment and oil interceptor.
- As required by equipment.

### Electrical

- Lighting
  - Waterproof high bay fluorescent.
- Power
  - Waterproof duplex receptacles, 120 VAC, 20A, GFI protected, on walls at 3'-6" AFF.
  - As required by equipment.
- Communications
  - Paging/intercom system speakers.
- Gas detection / alarm system for CNG fueled vehicles.

# FUNCTIONAL REQUIREMENTS

## Chassis Wash (Articulated Buses)

(Wash)

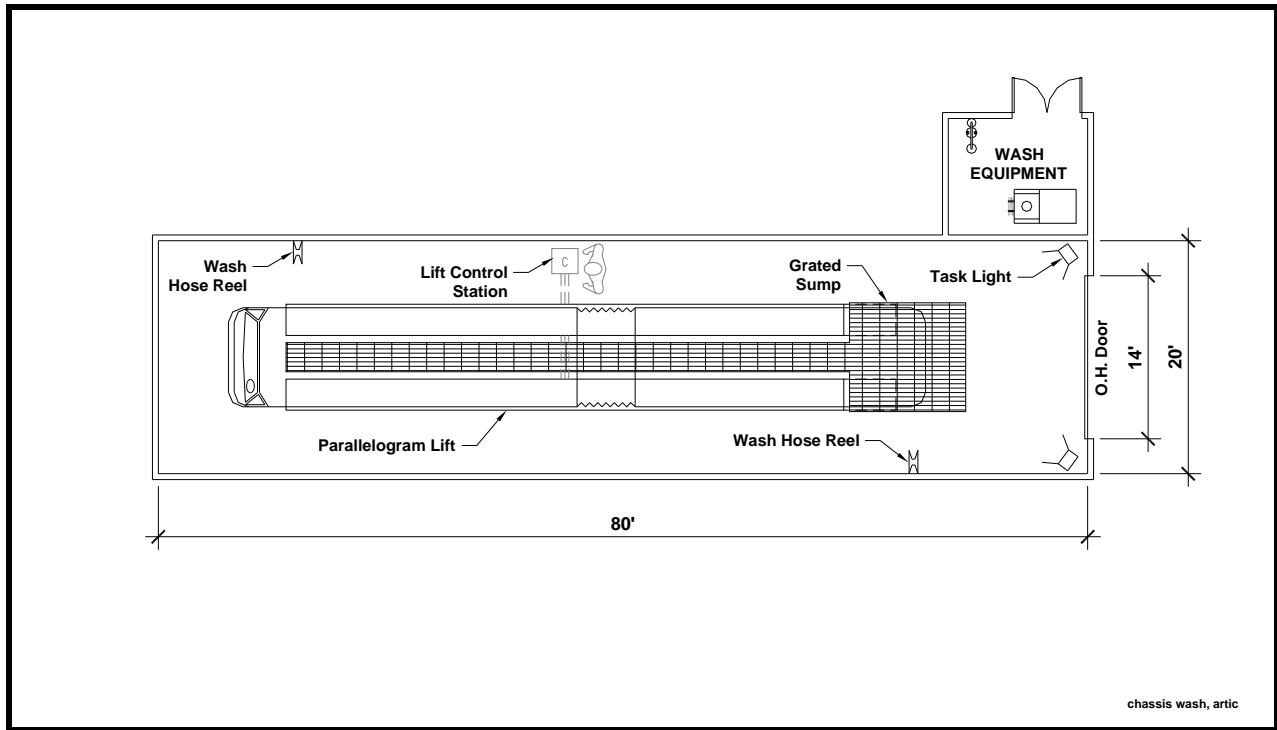

## FUNCTIONAL CHARACTERISTICS

### Function

- Enclosed bays for washing of articulated bus undercarriages, engine compartments, and components.

### Relationship to Other Areas

- Adjacent to Vehicle Wash Bay.

### Critical Dimensions

- 19'-0" vertical clearance.
- 20'-0" wide by 80'-0" long.

### Equipment/Furnishings

- Parallelogram ramp type lift, high pressure/hot water washer, and eye wash/safety shower.

### Comments

- Forklift access.

# FUNCTIONAL REQUIREMENTS

---

## TECHNICAL CONSIDERATIONS

### Architectural

- Finishes
  - Floor: Soil, grease, and water resistant concrete, with integral non-metallic hardener, and clear epoxy sealer. Provide slip resistant finish.
  - Walls: Soil and grease resistant. Epoxy painted to 8 feet AFF.
  - Ceiling: Painted exposed structure.
- Doors
  - Personnel doors to meet applicable codes and exiting requirements.
  - Exterior overhead door: 14' x 14' motor operated with interior push button controls, and lockout on exterior. Designed to withstand wet area.
- Bollards on exterior at jambs of overhead door (2 per door).

### Structural

- Control joints in floor slab at adequate spacing.
- Structure as needed to support equipment.

### Mechanical

- Heating system must be compatible with use of alternative fueled vehicles.
- Ventilation as required by codes to prevent accumulation of explosive mixtures.
- General ventilation as required by codes.
- As required by equipment.
- Must have good ventilation.

### Plumbing

- 3/4" water hose bib with standard faucet at 4'-0" AFF.
- Compressed air line with cut-off valve, filter regulator with gauge, lubricator, cleanout valve, and quick disconnects on walls at 4'-0" AFF. Provide disconnects at locations to be determined during detailed design.
- Sump pit between lift ramps (with removable grated cover) with drain to sediment and oil interceptor.
- As required by equipment.

### Electrical

- Lighting
  - Waterproof high bay fluorescent.
- Power
  - Waterproof duplex receptacles, 120 VAC, 20A, GFI protected, on walls at 3'-6" AFF.
  - As required by equipment.
- Communications
  - Paging/intercom system speakers.
- Gas detection / alarm system for CNG fueled vehicles.

# FUNCTIONAL REQUIREMENTS

## Detail Clean Bay (Standard Buses)

(Wash)

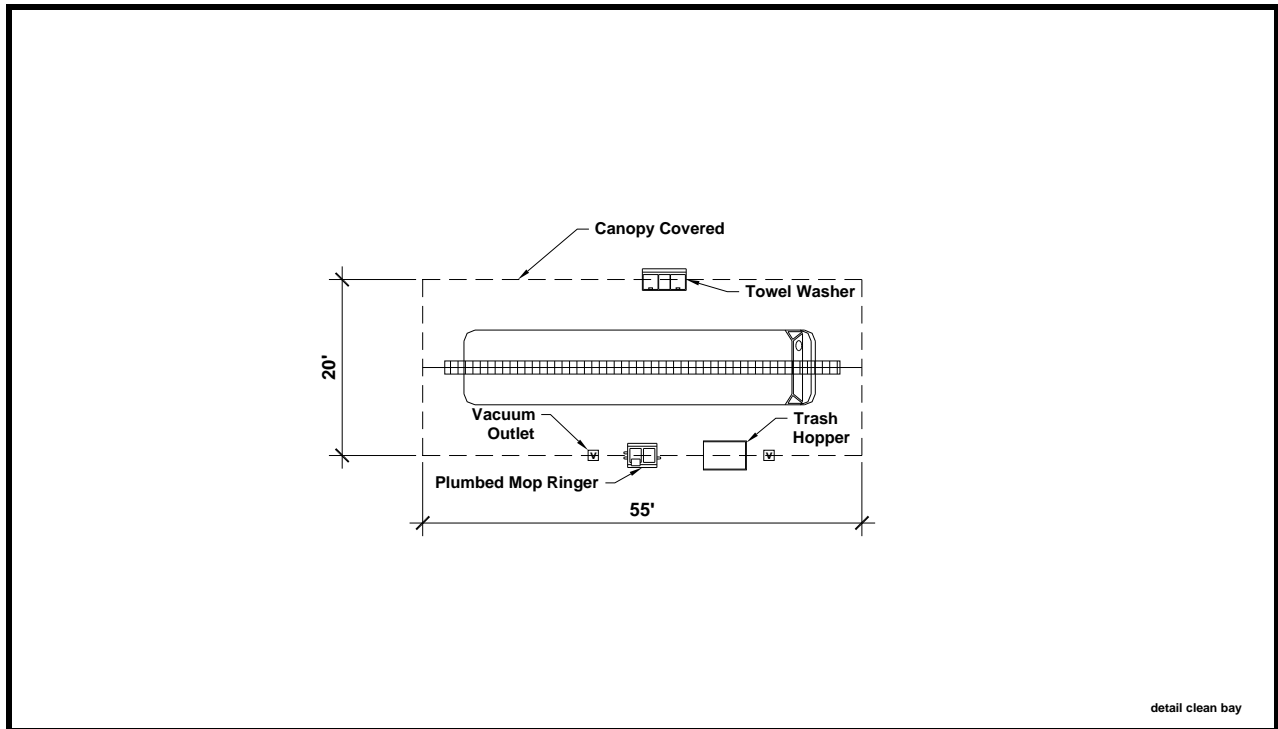

## FUNCTIONAL CHARACTERISTICS

### Function

- Enclosed area for detailed cleaning of transit buses.

### Relationship to Other Areas

- Adjacent to wash areas.

### Critical Dimensions

- 19'-0" vertical clearance.
- 20'-0" wide by 55'-0" long

### Equipment/Furnishings

- Fixed mop tank, central vacuum system outlet, trash hopper, towel washer / extractor, moveable ramps to tilt bus during cleaning.

### Comments

- Forklift access.
- Provide adequate light for interior of bus.

# FUNCTIONAL REQUIREMENTS

---

## TECHNICAL CONSIDERATIONS

### Architectural

- Finishes
  - Floor: Soil, grease, and water resistant concrete, with integral non-metallic hardener, and clear epoxy sealer. Provide slip resistant finish.
  - Walls: Soil and grease resistant. Epoxy painted to full height.
  - Ceiling: Painted exposed structure.
- Doors
  - None.
- Bollards as required to protect structure.

### Structural

- Control joints in floor slab at adequate spacing.
- Structure as needed to support equipment.

### Mechanical

- General ventilation as required by codes.
- As required by equipment.

### Plumbing

- 24" trench drain at mid bay (with removable cover) to sediment.
- 3/4" water hose bib with standard faucet at 3'-6" AFF.
- Compressed air line with cut-off valve, filter regulator with gauge, lubricator, cleanout valve, and quick disconnects on walls at 3'-6" AFF. Provide disconnects at locations to be determined during detailed design.
- As required by equipment.

### Electrical

- Lighting
  - High bay fluorescent.
- Power
  - Waterproof duplex receptacles, 120VAC, 20A, GFI protected, on walls at 3'-6" AFF.
  - As required by equipment.
- Communications
  - Paging/intercom system speakers.

# FUNCTIONAL REQUIREMENTS

## Detail Clean Bay (Articulated Buses)

(Wash)

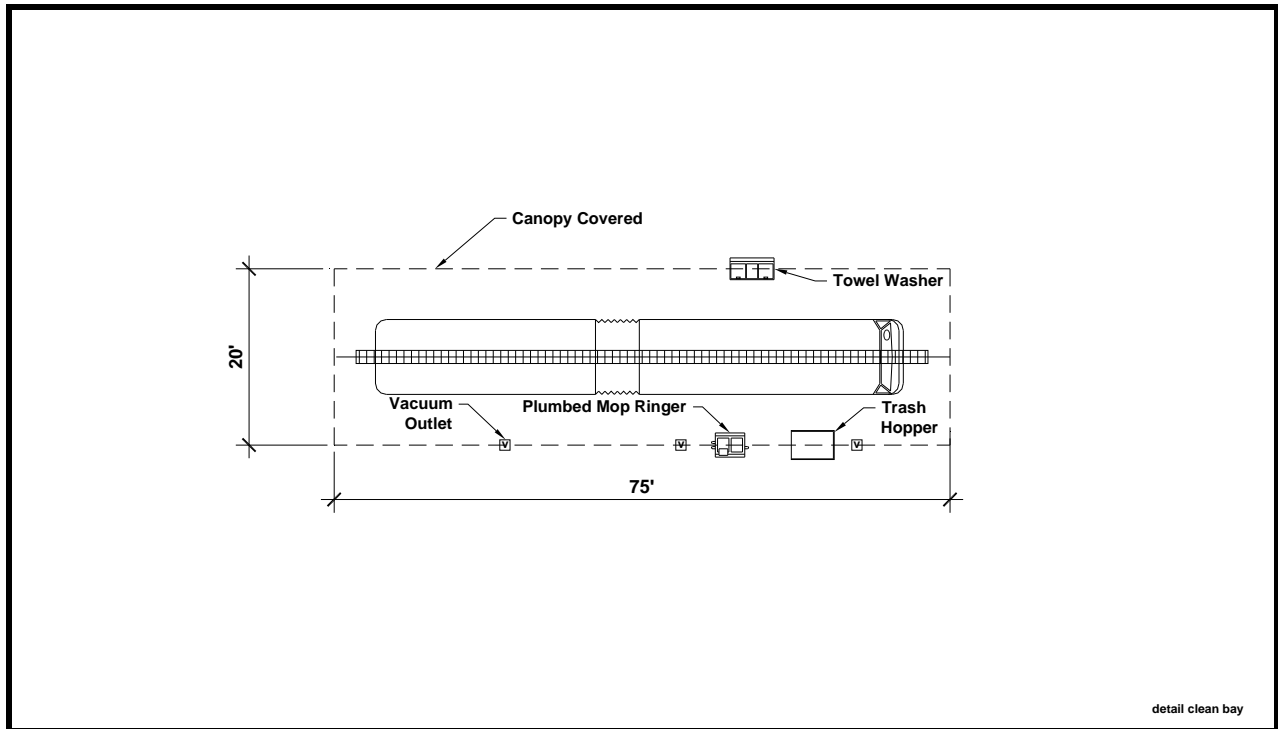

## FUNCTIONAL CHARACTERISTICS

### Function

- Enclosed area for detailed cleaning of transit buses.

### Relationship to Other Areas

- Adjacent to wash areas.

### Critical Dimensions

- 19'-0" vertical clearance.
- 20'-0" wide by 75'-0" long

### Equipment/Furnishings

- Fixed mop tank, central vacuum system outlet, trash hopper, towel washer / extractor, moveable ramps to tilt bus during cleaning.

### Comments

- Forklift access.
- Provide adequate light for interior of bus.

# FUNCTIONAL REQUIREMENTS

---

## TECHNICAL CONSIDERATIONS

### Architectural

- Finishes
  - Floor: Soil, grease, and water resistant concrete, with integral non-metallic hardener, and clear epoxy sealer. Provide slip resistant finish.
  - Walls: Soil and grease resistant. Epoxy painted to full height.
  - Ceiling: Painted exposed structure.
- Doors
  - None.
- Bollards as required to protect structure.

### Structural

- Control joints in floor slab at adequate spacing.
- Structure as needed to support equipment.

### Mechanical

- General ventilation as required by codes.
- As required by equipment.

### Plumbing

- 24" trench drain at mid bay (with removable cover) to sediment.
- 3/4" water hose bib with standard faucet at 3'-6" AFF.
- Compressed air line with cut-off valve, filter regulator with gauge, lubricator, cleanout valve, and quick disconnects on walls at 3'-6" AFF. Provide disconnects at locations to be determined during detailed design.
- As required by equipment.

### Electrical

- Lighting
  - High bay fluorescent.
- Power
  - Waterproof duplex receptacles, 120VAC, 20A, GFI protected, on walls at 3'-6" AFF.
  - As required by equipment.
- Communications
  - Paging/intercom system speakers.

# FUNCTIONAL REQUIREMENTS

---

## FACILITY MAINTENANCE

### FUNCTIONAL RELATIONSHIP DIAGRAM

The relationships between the various functional areas within this section are shown below. The design should accommodate these relationships in order to maximize operational efficiency. This diagram is not meant to be a floor plan, and serves only as a representational relationship diagram.

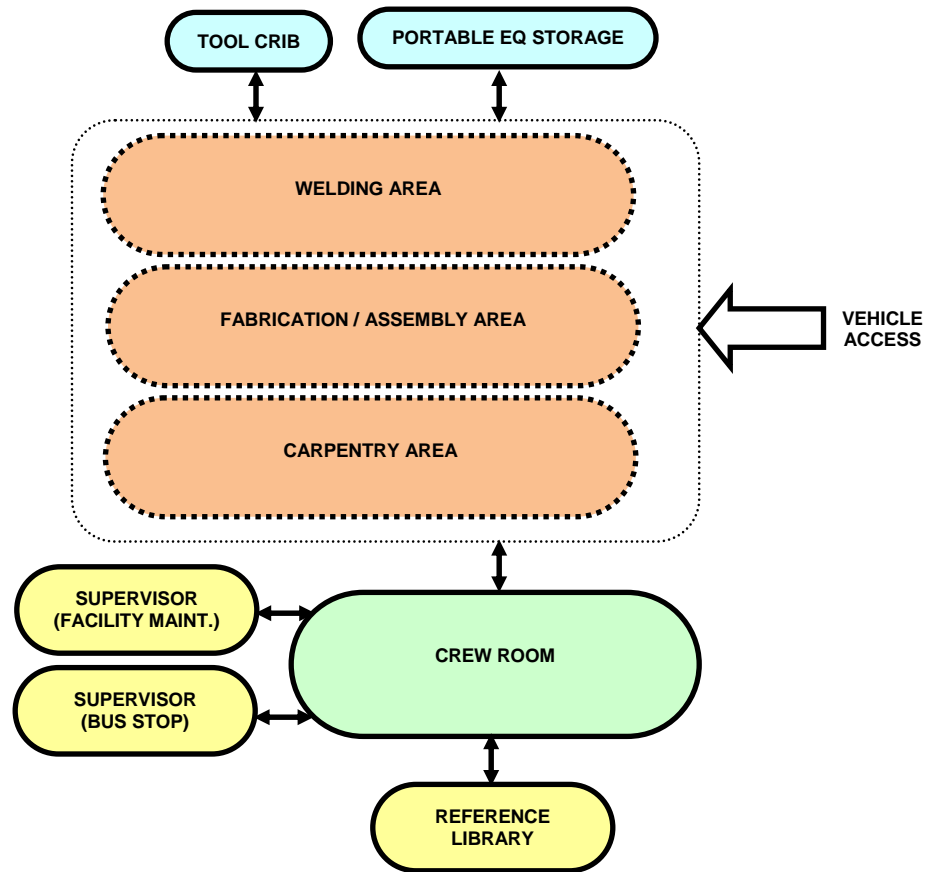

### FUNCTIONAL AREA MODULES

Each functional area within this section has been individually defined as a module. Each module has information regarding the function of the space, relationships to other areas and other information received during interviews with ABQ Ride staff.



# FUNCTIONAL REQUIREMENTS

## Supervisor – Facility Maintenance

(Facility Maintenance)

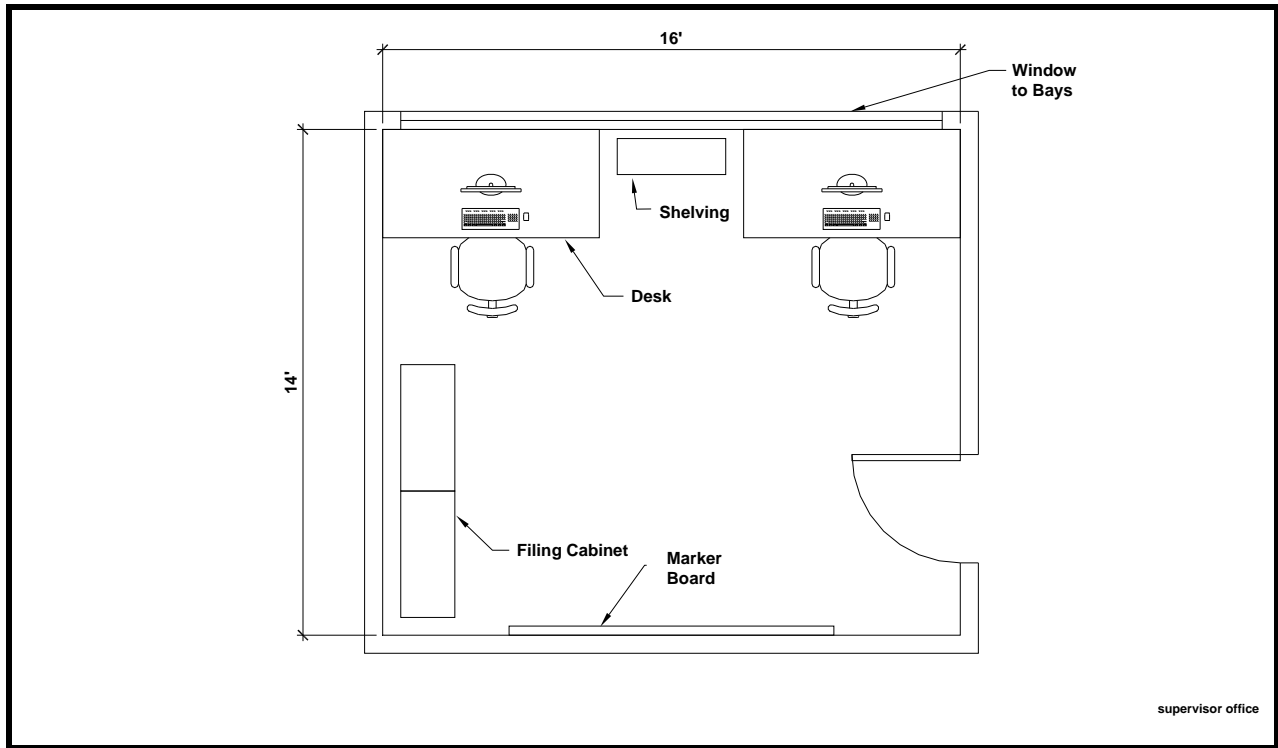

### Function

- Enclosed private office for both Facility Maintenance Supervisors.

### Relationship to Other Areas

- Adjacent to Facility Maintenance Crew Room.

### Comments/Characteristics

- Furnishings: Two desks, two chairs, marker board, shelving, file drawer, two phones, two computers, and printer.
- Utility Requirements: Grounded electrical convenience outlets, telephone, intercom/paging system, conduit for network computer system, air conditioned, and heated.
- Floor Finishes: Carpet.
- Wall Finishes: Painted gypsum board.
- Ceiling Finishes: Acoustical tile ceiling.
- Lighting: Office light fixture. Refer to chapter 4 for foot candle and fixture requirements.

# FUNCTIONAL REQUIREMENTS

## Supervisor – Bus Stop

(Facility Maintenance)

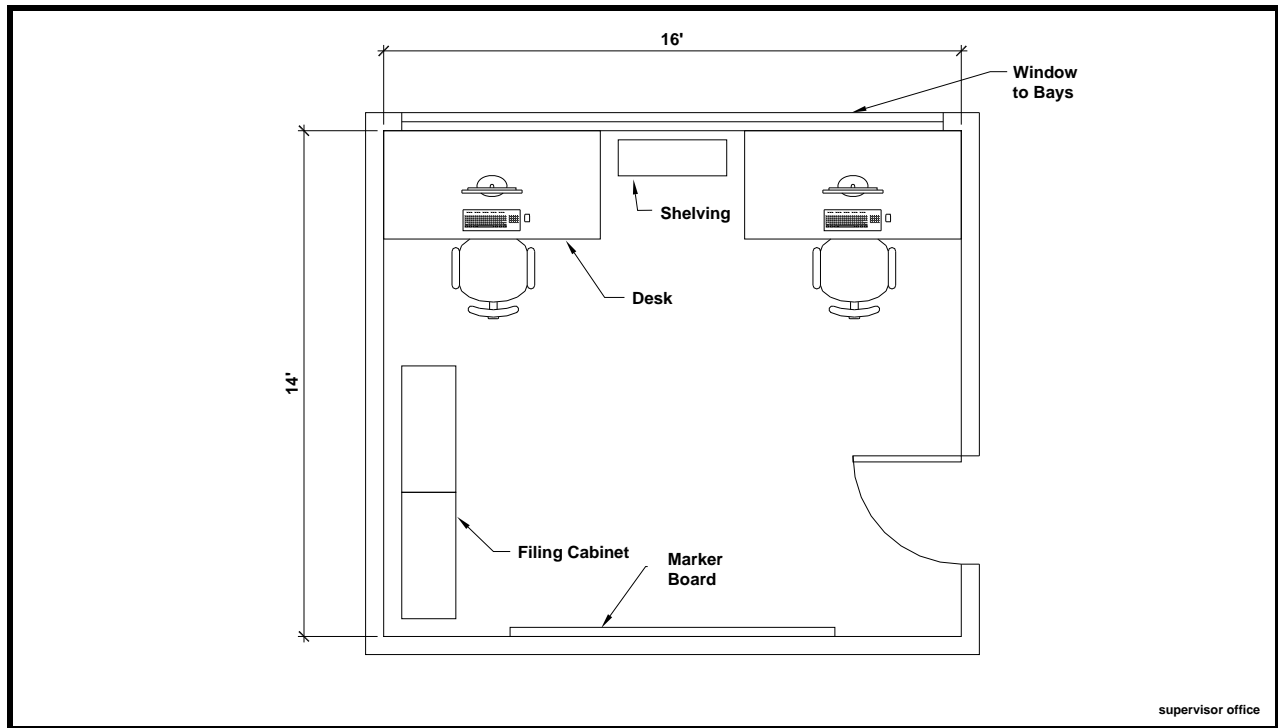

### Function

- Enclosed private office for both Bus Stop Supervisors.

### Relationship to Other Areas

- Adjacent to Facility Maintenance Crew Room.

### Comments/Characteristics

- Furnishings: Two desks, two chairs, marker board, shelving, file drawer, two phones, two computers, and printer.
- Utility Requirements: Grounded electrical convenience outlets, telephone, intercom/paging system, conduit for network computer system, air conditioned, and heated.
- Floor Finishes: Carpet.
- Wall Finishes: Painted gypsum board.
- Ceiling Finishes: Acoustical tile ceiling.
- Lighting: Office light fixture. Refer to chapter 4 for foot candle and fixture requirements.

# FUNCTIONAL REQUIREMENTS

## Crew Room

(Facility Maintenance)

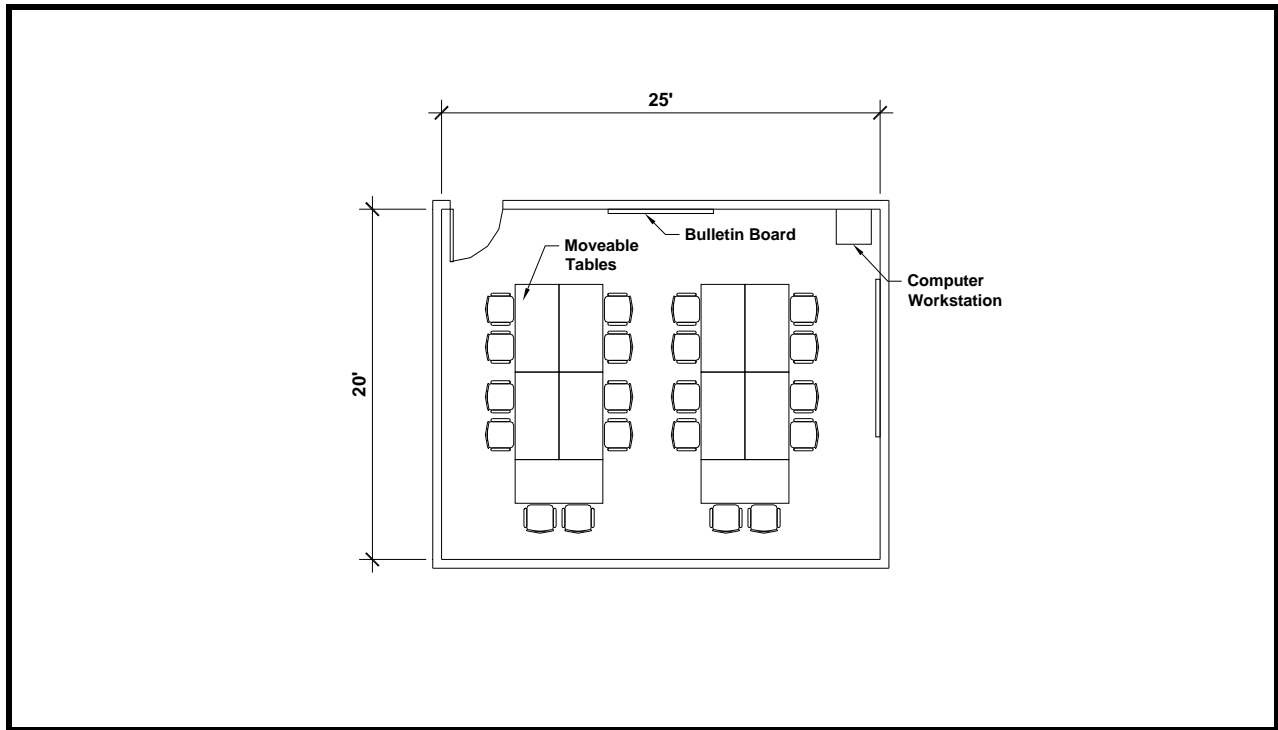

### Function

- Enclosed area for crews to prepare and leave for shifts from.
- Sized to accommodate 20 people.

### Relationship to Other Areas

- Adjacent to Facility Maintenance shops.
- Convenient to Facility Maintenance Parking.

### Comments/Characteristics

- Furnishings: Table and chairs for 20 people, computer workstation, and bulletin board
- Utility Requirements: Grounded electrical convenience outlets, telephone, data, air conditioned, and heated.
- Floor Finishes: Resilient flooring.
- Wall Finishes: Painted gypsum board.
- Ceiling Finishes: Acoustical tile ceiling.
- Lighting: Fluorescent. Refer to chapter 4 for foot candle requirements.

# FUNCTIONAL REQUIREMENTS

---

## Reference Library

*(Facility Maintenance)*

### Function

- Enclosed area for storage of Facility Maintenance reference materials.

### Relationship to Other Areas

- Convenient access to Break Room / Training Room.

### Comments/Characteristics

- Furnishings: None.
  - Utility Requirements: Grounded electrical convenience outlets, air conditioned, and heated.
  - Floor Finishes: Resilient flooring.
  - Wall Finishes: Painted gypsum board.
  - Ceiling Finishes: Acoustical tile ceiling.
- Lighting: Office light fixture. Refer to chapter 4 for foot candle and fixture requirements.

# FUNCTIONAL REQUIREMENTS

---

THIS PAGE LEFT INTENTIONALLY BLANK

# FUNCTIONAL REQUIREMENTS

## Facility Maintenance and Bus Stop Shop

(Facility Maintenance)

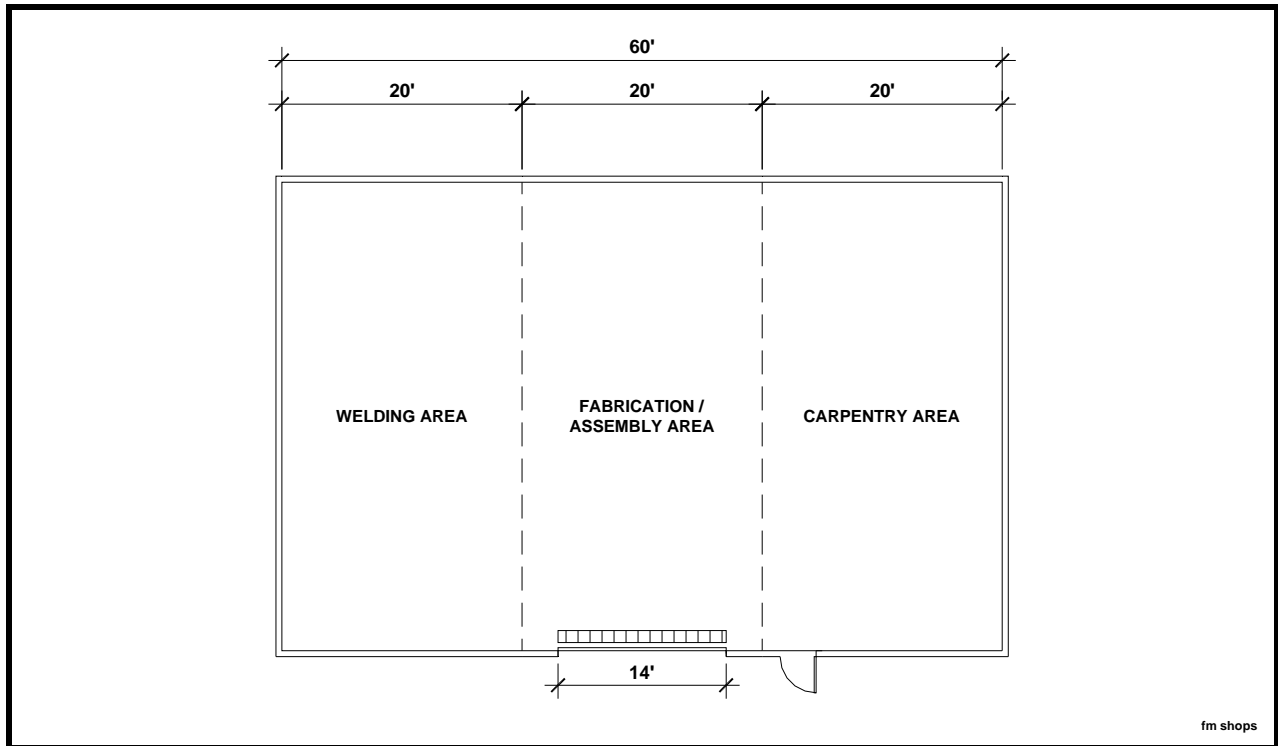

### FUNCTIONAL CHARACTERISTICS

#### Function

- Enclosed designated bay for welding.

#### Relationship to Other Areas

- Adjacent to Fabrication / Carpentry Area.
- Convenient to Crew Room.

#### Critical Dimensions

- 19'-0" vertical clear.
- 60'-0" wide by 40'-0" long.

#### Equipment / Furnishings

- Severe use workbench w/ vise, 2 ton crane, fall protection, steel plate & tubing storage, workbench w/ dry rod oven, band saw, buffer/grinder, drill/hydraulic press, cutting welding tables, plasma cutter, oxy / acetylene welder, MIG welder, welding screen, and articulating welding exhaust.

#### Comments

- Forklift access.

# FUNCTIONAL REQUIREMENTS

---

## TECHNICAL CONSIDERATIONS

### Architectural

- Finishes
  - Floor: Soil, grease, and water resistant concrete, with integral non-metallic hardener, and clear epoxy sealer. Provide slip resistant finish.
  - Walls: Soil and grease resistant. Epoxy painted to 8 feet AFF.
  - Ceiling: Painted exposed structure.
- Doors
  - Personnel doors to meet applicable codes and exiting requirements.
  - Exterior overhead door: 14' x 14' motor operated with interior push button controls, and lockout on exterior.
- Bollards on exterior at jambs of overhead door (2 per door).

### Structural

- Control joints in floor slab at adequate spacing.
- Structure as needed to support equipment.

### Mechanical

- Heating system must be compatible with possible future use of alternative fueled vehicles.
- Ventilation as required by codes to prevent accumulation of explosive mixtures.
- General ventilation as required by codes.
- As required by equipment.

### Plumbing

- 3/4" water hose bib with standard faucet at 4'-0" AFF.
- Compressed air line with cut-off valve, filter, and regulator with gauge, lubricator, cleanout valve, and quick disconnects on walls at 4'-0" AFF. Provide disconnects at locations to be determined during detailed design.
- As required by equipment.

### Electrical

- Lighting
  - High Bay Fixture. Refer to chapter 4 for foot candle lighting requirements.
- Power
  - Welding outlet, centrally located, 208 VAC, 1 ph, 50A and 480 VAC, 3 ph, 30A at 3'-6" AFF.
  - General-purpose duplex receptacles, 120 VAC, 20A, GFI protected, on walls at 3'-6" AFF.
  - As required by equipment.
- Communications
  - Paging/intercom system speakers.

# FUNCTIONAL REQUIREMENTS

---

## Material Storage

*(Facility Maintenance)*

### Function

- Enclosed secure area for the storage of Facility Maintenance materials.

### Relationship to Other Areas

- Adjacent to Parts Storeroom.

### Comments/Characteristics

- Furnishings: None.
- Utility requirements: Grounded electrical convenience outlets and heated.
- Floor: Soil, grease, and water resistant concrete, with integral non-metallic hardener, and clear epoxy sealer. Provide white slip resistant finish.
- Wall Finishes: Epoxy painted concrete block.
- Ceiling Finishes: Painted exposed structure.
- Lighting: Fluorescent. Refer to chapter 4 for foot candle requirements.

## Tool Crib

*(Facility Maintenance)*

### Function

- Enclosed secure area for the storage of maintenance tools and equipment.

### Relationship to Other Areas

- Adjacent to Parts Storeroom.
- Near repair bays and shops.

### Comments/Characteristics

- Furnishings: Shelving units, storage cabinets, and shadow boards.
- Utility requirements: Grounded electrical convenience outlets and heated.
- Floor Finishes: Soil, grease, and water resistant concrete, with clear epoxy sealer.
- Wall Finishes: Chain link fence.
- Ceiling Finishes: Painted exposed structure.
- Lighting: High bay fluorescent. Refer to Chapter 4 for foot candle lighting requirements.



# FUNCTIONAL REQUIREMENTS

---

## Portable Equipment Storage

*(Facility Maintenance)*

### Function

- Enclosed secure area for the storage of portable shop equipment.

### Relationship to Other Areas

- Adjacent to Fabrication / Carpentry Area.

### Comments/Characteristics

- Furnishings: None.
- Utility requirements: Grounded electrical convenience outlets and heated.
- Floor: Soil, grease, and water resistant concrete, with integral non-metallic hardener, and clear epoxy sealer. Provide white slip resistant finish.
- Wall Finishes: Epoxy painted concrete block.
- Ceiling Finishes: Painted exposed structure.
- Lighting: Fluorescent. Refer to chapter 4 for foot candle requirements.

# FUNCTIONAL REQUIREMENTS

---

## AGENCY VEHICLE PARKING

### FUNCTIONAL AREA MODULES

Each functional area within this section has been individually defined as a module. Each module has information regarding the function of the space, relationships to other areas, critical dimensions (if any), equipment/furnishings, and finishes. Technical considerations for ventilation, mechanical, plumbing, and electrical are also defined. A detailed equipment list for each space will be developed during design.

#### **Ready Line**

*(Agency Vehicle Parking)*

##### Function

- Designated area for fully operable fleet vehicles.

##### Relationship to Other Areas

- Located to optimize vehicle and pedestrian traffic flows.

##### Comments/Characteristics

- Furnishings: None.
- Utility requirements: Intercom/paging system.
- Floor Finishes: Air entrained concrete.
- Wall Finishes: None.
- Ceiling Finishes: None.
- Lighting: Site lighting fixture. Refer to chapter 4 for foot candle and fixture requirements.
- Parking spaces shall be numbered.
- Canopy covered if possible.

#### **Down Line**

*(Agency Vehicle Parking)*

##### Function

- Designated area for buses waiting for maintenance.

##### Relationship to Other Areas

- Located to optimize vehicle and pedestrian traffic flows.
- Accessible to Maintenance Repair bays.

##### Comments/Characteristics

- Furnishings: None.
- Utility requirements: Intercom/paging system.
- Floor Finishes: Air entrained concrete.
- Wall Finishes: None.
- Ceiling Finishes: None.
- Lighting: Site lighting fixture. Refer to chapter 4 for foot candle and fixture requirements.

# FUNCTIONAL REQUIREMENTS

---

## **Non-Revenue Vehicle Parking**

*(Agency Vehicle Parking)*

### Function

- Designated area for support vehicles.

### Relationship to Other Areas

- Located to optimize vehicle and pedestrian traffic flows.

### Comments/Characteristics

- Furnishings: None.
- Utility requirements: Intercom/paging system.
- Floor Finishes: Air entrained concrete.
- Wall Finishes: None.
- Ceiling Finishes: None.
- Lighting: Site lighting fixture. Refer to chapter 4 for foot candle and fixture requirements.
- Parking spaces shall be numbered.

# FUNCTIONAL REQUIREMENTS

---

## PRIVATE VEHICLE PARKING

### FUNCTIONAL AREA MODULES

Each functional area within this section has been individually defined as a module. Each module has information regarding the function of the space, relationships to other areas, critical dimensions (if any), equipment/furnishings, and finishes. Technical considerations for ventilation, mechanical, plumbing, and electrical are also defined. A detailed equipment list for each space will be developed during design.

#### **Employee Parking**

*(Personal Vehicle Parking)*

##### Function

- Designated area for employee vehicles.

##### Relationship to Other Areas

- Located to optimize vehicle and pedestrian traffic flows.

##### Comments/Characteristics

- Furnishings: None.
- Utility requirements: Intercom/paging system.
- Floor Finishes: Asphalt or Concrete.
- Wall Finishes: None.
- Ceiling Finishes: None.
- Lighting: Site lighting fixture. Refer to chapter 4 for foot candle and fixture requirements.
- Incorporate parking for police vehicle.

#### **Visitor Parking**

*(Personal Vehicle Parking)*

##### Function

- Designated parking area for visitors.

##### Relationship to Other Areas

- Located to optimize vehicle and pedestrian traffic flows.

##### Comments/Characteristics

- Furnishings: None.
- Utility requirements: Intercom/paging system.
- Floor Finishes: Asphalt or Concrete.
- Wall Finishes: None.
- Ceiling Finishes: None.
- Lighting: Site lighting fixture. Refer to chapter 4 for foot candle and fixture requirements.

# FUNCTIONAL REQUIREMENTS

---

## OTHER SITE AREAS

### FUNCTIONAL AREA MODULES

Each functional area within this section has been individually defined as a module. Each module has information regarding the function of the space, relationships to other areas, critical dimensions (if any), equipment/furnishings, and finishes. Technical considerations for ventilation, mechanical, plumbing, and electrical are also defined. A detailed equipment list for each space will be developed during design.

#### **Guard House**

*(Other Site Areas)*

##### Function

- Security Kiosk for site and building security.

##### Relationship to Other Areas

- Located at Agency Vehicle entrance.

##### Comments/Characteristics

- Furnishings: Workstation w/ chair, phone, computer, and printer.
- Utility Requirements: Grounded electrical convenience outlets, telephone, intercom/paging system, conduit for network computer system, air conditioned, and heated.
- Floor Finishes: Resilient flooring.
- Wall Finishes: Epoxy painted gypsum board and/or concrete block.
- Ceiling Finishes: Acoustical tile ceiling.
- Lighting: High pressure sodium. Refer to Chapter 4 for foot candle lighting requirements.
- Could use pre-manufactured kiosk in lieu of above finishes.

#### **Emergency Generator**

*(Other Site Areas)*

##### Function

- Designated area for the site emergency generator.

##### Relationship to Other Areas

- Centrally located.

##### Comments/Characteristics

- Furnishings: Emergency generator.
- Utility requirements: As required by equipment.
- Floor Finishes: Exposed concrete.
- Wall Finishes: Epoxy painted concrete block.
- Ceiling Finishes: None.
- Lighting: Refer to Chapter 4 for lighting requirements.

# FUNCTIONAL REQUIREMENTS

---

## Yard Storage

*(Other Site Areas)*

### Function

- Secure yard storage area for miscellaneous materials.

### Relationship to Other Areas

- Convenient access to/from vehicle parking.
- Efficiently located within site traffic flow.

### Comments/Characteristics

- Furnishings: None.
- Utility requirements: None.
- Floor Finishes: Concrete or asphalt.
- Wall Finishes: None.
- Ceiling Finishes: None.
- Lighting: High pressure sodium. Security type lighting typical for parking areas.
- Paging/intercom system speakers.

## Dumpsters / Recycling

*(Other Site Areas)*

### Function

- Designated area for staging of dumpsters / recycling bins.

### Relationship to Other Areas

- Located to optimize vehicle and pedestrian traffic flows.

### Comments/Characteristics

- Furnishings: 30 CY roll-off dumpsters (one for metal / scrap recycle, one for wood / plastic / paper recycle and additional dumpsters for trash as shown in space program).
- Utility requirements: Intercom/paging system speakers.
- Floor Finishes: Concrete.
- Wall Finishes: None.
- Ceiling Finishes: None.
- Lighting: Site lighting fixture. Refer to chapter 4 for foot candle and fixture requirements.



---

**SECTION 4: SITE & BUILDING REQUIREMENTS**





# SITE AND BUILDING REQUIREMENTS

---

## **CODES, STANDARDS, AND PERMITS**

- All design elements shall be based on the requirements of local, state, and National Codes and standards. Due to the unique functions associated with this type of facility, a detailed code review shall be performed at the beginning of detailed design to incorporate all codes and standards related to the facility.
- The code review shall include listing and discussion of fire prevention methods, occupancy separations, and area classifications. Particular attention must be given to the impacts of the use of fuel cells and other alternative fuels.
- A comprehensive list of all permits required from national, state, and local authorities, utility owners, and other private entities shall be prepared and included in the preliminary design submittal.
- The design shall meet all applicable regulatory requirements for the handling, storage and waste disposal of hazardous materials.
- The Yale Maintenance Facility shall be accessible to persons with disabilities in accordance with ADA Accessibility Guidelines (ADAAG) and the City of Albuquerque.
- The design must meet all applicable State and local energy standards, policy & guidelines.

## **CIVIL**

The civil design should address the following issues. These issues are not meant to represent the full extent of civil involvement, and are only intended to convey basic functional requirements in an effort to facilitate coordination during detailed design.

### **Survey**

- A survey of the site will be provided by ABQ Ride showing all pertinent existing boundaries, property lines, above and below ground utilities, easements, and topography. Underground utility location shall be verified by potholing where necessary.

### **Soils, Earth Relocation, and Other Considerations**

- A geotechnical investigation will be provided by ABQ Ride with detailed information regarding surface and subsurface soil conditions.
- Recommendations from the geotechnical investigation shall be utilized in site development design.

### **Streets**

- Any improvements required for existing streets should be designed to conform to applicable standards and codes, and shall be approved by the responsible authority.

# SITE AND BUILDING REQUIREMENTS

---

## Parking Lots

- Concrete should be provided for all driveways and agency vehicle parking areas.
- Concrete should be provided for all fueling positions, vehicle washing, vehicle details and dumpster areas.
- Driveways into the site must be sufficient to accommodate heavy loads and frequent traffic.
- Asphalt paving with concrete curbs is sufficient for exterior employee/visitor parking areas.
- Concrete wheel stops and/or curbs should be furnished in automobile parking lots only where required for physical protection of buildings, landscaping, fencing, and as needed for storm drainage. Use of curbs should be limited allowing as much storm water as possible to return to the ground.
- A concrete apron should be provided for access to all bays, fueling lanes, and vehicle washers. Concrete bypass lanes should also be provided around these facilities where practical.
- All slopes should be perpendicular to vehicle parking where practical.
- Vehicle parking areas shall include pavement markings, signs, sidewalks, and lighting as required for safe and efficient operations.
- Pavement markings shall be paint striping with no projections so that the surface can be easily swept and cleaned.
- Pavement markings shall be thermoplastic.
- Low profile fully adhered RPM's (Raised Pavement Marker) with reflective surfaces to be utilized on crosswalks, handicap spaces, and circulation routes.
- Landscaping in employee/visitor parking areas should be provided as recommended by the local jurisdictions.
- Parking spaces and passenger loading zones shall be provided to comply with Accessibility Standards and all codes and ordinances enforced by the City of Albuquerque.

## Site Drainage

- All storm drains shall be routed to a central sampling point in a location to be determined by the City of Albuquerque.
- New pavement grades should be established with an attempt to maintain a minimal grade of 1.00% (asphalt) and an absolute minimum grade of .5% (concrete). Maximum pavement grades should be limited to 6%. If greater slopes are required, care must be taken to ensure that vehicles will not bottom-out due to abrupt grade changes.
- Adequate quantities and sizes of catch basins and drains should be provided to keep paved areas free of standing water during normal rainfall.
- Site drainage should include oil/water separation and retention/detention as required by state and local codes prior to discharge into storm sewer, sanitary sewer, or natural outlet location.

# SITE AND BUILDING REQUIREMENTS

---

- Building foundation elevations should be integrated to the site drainage to avoid the need for stairways at personnel entrances and excessive grades at vehicle entrances.
- Drainage should always be directed away from buildings and facilities.
- Drainage design shall address wetlands protection and avoidance if wetlands are present.
- All outside vehicle maintenance areas to be canopy covered.

## Site Utilities

- Electrical, telephone, water, irrigation water, natural gas, sanitary sewer, and storm drainage/retention availability, capacity, and characteristics should be determined by the detailed design team.
- All utility services shall conform to local codes and requirements.
- All utility services should be underground.
- The specification should stipulate that the contractor is to pay for any tap-in fees.
- Single point electrical service should be provided to the facility by the local power utility, except for CNG fueling equipment.
- A second point of electrical service to major CNG fueling equipment, such as CNG compressor stations, dryers, CNG fueling controls, should be high voltage service if possible.

## LANDSCAPE

The landscape design should address the following issues. These issues are not meant to represent the full extent of the landscape architect's involvement, and are only intended to convey basic fundamental requirements in an effort to facilitate coordination during detailed design.

## Vegetation

- Vegetation should consist of low maintenance, drought resistant types.
- Vegetation that is compatible and indigenous to the surrounding area is preferred.
- Vegetation, decorative fencing, and berms should be used to screen parking areas and maintenance areas from the public view as applicable.
- A small lawn area would be appropriate near the main or visitors entry to the facility.
- Vegetation should be placed to avoid conflict with visibility needs for vehicle circulation, ingress, and egress.
- Consideration should be given to perimeter vegetation selection and placement to avoid its use as a screen for criminal or undesirable social activities.
- Landscaping should be provided in employee/visitor parking areas and for any street improvements in the City of Albuquerque right-of-way as recommended by the local jurisdictions, including county input.

## **SITE AND BUILDING REQUIREMENTS**

---

- Consideration will be given to the size of fully mature plantings with respect to site lighting and parking lot safety concerns.

# SITE AND BUILDING REQUIREMENTS

---

## **Irrigation**

- All new landscaped areas shall be provided with an automated drip irrigation system.
- Irrigation system shall conform to local water use standards and limitations.
- Underground piping circuit lengths shall be minimized and sized to reduce required water delivery time to appropriate durations.
- Irrigation shall be provided with an automatic controller, separate water meter, water backflow devices, control valves, zones, pipe irrigation system, and rain sensor with automatic shutoffs.

## **STRUCTURAL**

The structural design should address the following issues. These issues are not meant to represent the full extent of structural involvement, and are only intended to convey basic fundamental requirements in an effort to facilitate coordination during detailed design. Refer to “CNG Impacts” later in this chapter for additional requirements.

## **Foundations**

- Foundation design shall be based on the recommendation of the geotechnical investigation reports.
- Control joints in floor slab shall be provided at adequate spacing, to minimize cracking.

## **Floor Load Ratings**

- Floor loads shall be determined by occupancy per accepted codes and standards.
- Where practical, floor loads should be consistent for all occupancies on a given floor.

## **Structural Steel**

- Structural members should be provided with corrosion protective coatings based on the functions of spaces in which they are exposed.
- Exposed joists and other structural members shall be provided with ample future loading for miscellaneous support loads.
- Use of open frame structural members will facilitate air movement and prevent accumulation of flammable gases.

## **Trenches (drain and piping) and Sumps (drained and collection)**

- Trenches and sumps should be coordinated with structures, architectural elements, mechanical and utilities, and fixed equipment.
- Trenches and sumps should be covered with steel plate or grating consistent with the floor loading and finishes specified for the space served.
- All trench and sump grates to be removable. Grates to be a manageable and readily removable size.

# SITE AND BUILDING REQUIREMENTS

---

- Do not install equipment and fixtures in such a way as to limit the ability to remove grating for trench and sump cleaning and maintenance.
- Steel support beams and angles or nosing should be imbedded in the trench or sump mouth to support the trench covers and to prevent trench wall spalling.
- Trench and sump walls and floor finishes should be epoxy coated to prevent excursions of the piping fluids (see Plumbing) into or through the concrete.
- Trench bottoms shall slope to drainage or collection points as required.
- All piping trenches shall be drained to an oil / water separator.
- The method of pipe support attachment in the trench shall be detailed to provide adequate space for future piping modifications/replacement and keep the pipe off of the trench bottom.
- All piping and support systems (i.e., hydraulic oil ASME vessels, lift cylinders, etc.) must be connected in leak proof vaults and trenches to collect leakage and help facilitate inspection/testing /maintenance.

## Miscellaneous Steel

- Trench and sump coverings and other gratings should be tied down and flush with adjacent floor/pavement surfaces.
- Trench and sump coverings and other removable gratings should be fabricated in sections that can be easily removed and replaced by one person. For sections too heavy/large to be handled by one person, lifting lugs/eyes should be incorporated into the design.

## Vehicle Lifts

- Lift installation design shall be based on the lifts specified. The final lift installation details may vary based on the approved lift manufacturer. A note shall be placed on the construction drawings indicating that actual dimensions and details shall be coordinated with the approved manufacturer.
- If portable screw type lifts are utilized, the specifications must include brake motors with an electro-mechanically controlled device.
- All floor depression/pits for vehicle lifts shall be drained to an oil / water separator.

## Cranes

- Crane installation design should be based on the cranes specified. The final crane details and installation requirements may vary based on the approved crane manufacturer. A note shall be placed on the construction drawings indicating that actual dimensions and details shall be coordinated with the approved manufacturer.

# SITE AND BUILDING REQUIREMENTS

---

## **ARCHITECTURAL**

The architectural design should address the following issues. These issues are not meant to represent the full extent of the architect's involvement, and are only intended to convey basic fundamental requirements in an effort to facilitate coordination during detailed design. Refer to "CNG Impacts" later in this chapter for additional requirements.

### **General Considerations**

- The overall architecture of the facility and its aesthetics should create the feeling of unity and proper relationship of all components.
- The facility design shall be ADA compliant.
- The facility should be oriented to take advantage of cross ventilation in the work bays, if practical.
- Natural light should be utilized wherever possible. Vertical orientation (windows) should be used instead of horizontal orientation (skylights) to avoid problems with leaking.
- This will be a "no smoking" facility.
- Avoid "air pockets" in vehicle bays where explosive gases could accumulate at the ceiling.
- Architect should include LEED design feature options for the City's coordination.
- Slope roof structure of maintenance bays to a high point to facilitate evacuation of flammable gasses.
- Expandability and flexibility are important factors to consider in planning the building.
- The building should provide employee amenities and convey sense of pride and professionalism.
- The design will provide the necessary separations between building occupancies as required by code.
- Design "open" structures for fuel and wash such that lighter than air gases are not trapped below the roof.

### **Design Dimensions and Clearances**

The design of the facility must allow for safe and efficient movement of personnel, equipment, agency vehicles, and delivery vehicles. In order to provide proper clearances, the following minimum unobstructed clearances will be maintained. Note that "unobstructed clearance" means structure, lighting, mechanical ductwork, and any other obstructions must be above the minimum vertical clearances indicated.

- Hallways, Doorways, Interior Grade Changes, and Restrooms: ADA standards.
- Ceiling Clearances (minimums):
  - Offices areas: 8'-6".
  - Parts Rooms: 12'-0".
  - Shops: 14'-0".
  - Repair Bays: 19'-0".

# SITE AND BUILDING REQUIREMENTS

---

- Vehicle Washer: 16'-0".
- Door Openings (width by height):
  - Parts Rooms: 10'x10' (interior) and 12'x14' (exterior at Loading Dock).
  - Shops: 10'x10' (for forklift access).
  - Repair Bays: 14'x14'.
  - Vehicle Washer: 14'x14'.
  - Any door to accommodate vehicle traffic: 14'x14'.
- Circulation (width):
  - Pedestrian corridors: 6'-0".
  - Forklift aisles: 10'-0".
- Work Area:
  - Engine end of vehicle: 10'-0".
  - Opposite end of vehicle: 5'-0".
- Bay Width and Depth (width x depth):
  - Repair Bays:
    - Standard Coaches: 20'x55' (25' wide when adjacent to a wall).
    - Articulated Coaches: 20'x75' (25' wide when adjacent to a wall).
  - Steam Clean Bay: 20'x75'.
- Parking Space Dimensions (width x length):
  - 40' Transit Coaches: 14'x45'.
  - Articulated Coaches: 14'x65'.
  - Support/Employee/Visitor Vehicles: 10'x20'.
  - Handicap Parking Stall: per ADA standards.
- Turning and Circulation Requirements (90° turn):
  - Medium vehicle (auto, light truck, van): 25'.
  - Transit Coaches: 70'.
  - Forklift: 12'.

## Materials

The facility design should utilize materials that not only are aesthetically pleasing, but are also durable and cost effective. The materials should also be appropriate for the functional area in which they are used. Some of the areas in which careful selection of materials is very important due to the specialized functions are:

- Vehicle Washers.
- Steam Clean Bay.
- Lube/Compressor Room.



# SITE AND BUILDING REQUIREMENTS

---

If a composite wall system is used, CMU or another hard surface should be used at least up to eight feet above finished floors. Mechanical fasteners that are exposed to the weather or a wet environment should be constructed from stainless steel.

## Floors

- Floors in all repair bays and shops shall be flat with no slope.
- Floors in wash bays shall slope to the trench drains.

## Floor Load Ratings

- Floor loads shall be determined by occupancy per accepted codes and standards
- Where practical, floor loads shall be consistent for all occupancies on a given floor.

## Finishes

Room finishes are an important element in the design of this type facility. The wrong finish can not only be dangerous, but can also be very costly to replace. The following are specialized finishes inherent with maintenance functions:

- Epoxy painted CMU walls in all repair bays and maintenance shops.
- Epoxy painted CMU walls or glazed block with epoxy grout in vehicle wash areas.
- Soil and grease resistant walls.
- Painted exposed ceiling structure (light reflective color).
- Soil, grease, and water resistant concrete floors with an integral non-metallic hardener, light reflective coloring, and sealer.

## Doors

- All door types and materials should be standardized throughout the facility except in spaces that have hostile, corrosive environments, such as wash areas and chemical storage.
- Exterior overhead garage doors should be insulated high lift aluminum frame type with full view glass panels.
- Door controls shall allow for only full up or down (not partially closed). Doors shall open completely.
- Door thresholds should be avoided in maintenance and shop areas unless necessary. If thresholds are required, they should be of industrial grade in maintenance and shop areas.
- Doors and doorways should meet applicable accessibility requirements.
- All shop doors entering onto corridors should have automatic fire closures.
- All overhead doors shall have a manual override and ability to be raised and lowered manually.
- Doorframes shall be all welded. Knockdown type frames are not acceptable.

# SITE AND BUILDING REQUIREMENTS

---

## **Bollards**

- Protective bollards should be provided at all overhead doors and where protection of personnel, structures, and equipment are deemed necessary.
- Steel curb faces and corner edges should be provided at all raised concrete islands associated with protecting the building or equipment.

## **Housekeeping Pads**

- Housekeeping pads and isolation pads should be provided for appropriate electrical, mechanical, and plumbing equipment. Other housekeeping pads may be functionally necessary for some shop equipment.
- Housekeeping pad and isolation pad design should be coordinated with the structural engineer to ensure pad strength and uniformity throughout the facility.
- Exposed housekeeping pad surfaces should drain away from the equipment supported on them.
- Housekeeping pad surface finishes should be consistent with room floor finishes.

## **MECHANICAL**

The mechanical design should address the following issues. These issues are not meant to represent the full extent of mechanical involvement, and are only intended to convey basic functional requirements in an effort to facilitate coordination during detailed design. Refer to “CNG Impacts” later in this chapter for additional requirements.

## **Heating, Ventilation and Air Conditioning**

- All enclosed occupied building areas should be provided with heating and ventilation in accordance with code requirements.
- All office areas should be provided with air conditioning and heating to 72 degrees Fahrenheit, 50% relative humidity.
- Air conditioning in areas with communication equipment, computers, data, servers, AVL and security equipment should maintain a temperature of 68 degrees Fahrenheit with 50% ± 5% relative humidity year round. These spaces should have a separate HVAC system.
- Positive pressure must be maintained in all offices and break rooms adjacent to repair bays to preclude migration of fumes into these areas.
- Restroom areas should maintain negative pressure, drawing air from adjacent spaces for ventilation.
- Ventilation of repair bays should include a portion of supply air inlets near the floor and exhaust inlets near the ceiling.
- Maintenance areas should be positively ventilated and heated with particular attention to the effects of air movement on the perception of comfort.

# SITE AND BUILDING REQUIREMENTS

---

- Provide for smoke and heat venting in repair areas. Make use of smoke curtain boards as required. Do not create air pockets at ceiling.
- Spot cooling in maintenance areas, per ASHRAE, should provide for a velocity of 200 fpm across the worker. Supply should be via personal cooling fans near a bay opening; exhaust via fans in a mechanical penthouse (monitor exhaust system).
- Repair, inspection, and body repair areas shall be ventilated by at-floor exhaust and basement/pit exhaust systems conforming to the ventilation requirements of NFPA 513 and NFPA 30A. These systems will remove vapors which are heavier than air.
- Provide smoke, CO<sub>2</sub>, NO<sub>x</sub> detectors in vehicle areas to adjust ventilation rates in response to vehicle activity.
- Mechanical systems must be “zoned” so that adjustments can be made in response to varying demand and activity.
- HVAC management control system shall be computer controlled and accessible by Facilities Maintenance through the City internal computer network system.

## Exhaust Ventilation

- Exhaust ventilation, where required, should be provided in accordance with all applicable codes.
- An overhead vehicle exhaust reel system should be provided for all vehicle maintenance bays. Reels should be located at the appropriate end of each stall. Economies should be reviewed for service of a large number of exhaust reels by a single, variable speed exhaust fan as compared to multiple exhaust fans (one per reel). Adapters should be provided to accommodate each different bus type in the fleet.
- Vehicle exhaust hose should be selected for continuous operation at the high temperatures resulting from CNG and diesel bus exhaust.
- Vehicle exhaust ductwork should be selected for corrosion resistance.
- Dust collection systems must be installed and maintained in compliance with all applicable codes.

## Energy Conservation and Management

- Mechanical and electrical design efforts should coordinate to evaluate the cost effectiveness of the following:
  - Using high efficiency motors.
  - Duty cycling of HVAC systems (rotating "off" periods).
  - Demand load shedding controllers for non-essential HVAC motors.
  - Reduced voltage or current limiting starting for large motors.
  - Power factor correction for large motors.
  - High efficiency cooling and heat recovery units.

# SITE AND BUILDING REQUIREMENTS

---

- Use of automatic dampers and variable frequency motor controllers to allow a central fan to efficiently collect exhaust from only the exhaust hose reels in use, even though several reels are ganged together via common ductwork to the central fan.
- Soft start capability for larger motors (40 hp or greater).
- Consideration should be given to over sizing long pipe and duct runs where reasonable paybacks can be achieved through reduced brake horsepower requirements and reduced electrical consumption.
- Consideration should be given to the use of heat recovery in ventilation for compliance with energy codes and economy of operation.
- Passive solar solutions (orientation, natural lighting, cross ventilation) should be evaluated.
- A centralized Energy Management System (EMS) should be justified based on the following criteria, among others:
  - Ability to conform to peak load criteria for energy cost savings.
  - Automated equipment maintenance scheduling resulting in lower anticipated equipment life cycle costs.
  - Benefits of monitoring equipment performance to be within acceptable limits.
  - Utility usage patterns.
  - Temperature setbacks corresponding to occupancy and utilization patterns.
  - Uniform and limited control of temperature settings.
  - Filter performance monitoring and replacement pattern data accumulation.
  - Ability to monitor and record indoor and outdoor conditions affecting HVAC systems, as well as alarms, failures, and abnormal operating conditions.
  - Ability to automatically control selected equipment such as chillers, air handlers, pumps, fans, boilers, heaters, valves, and automated dampers, as well as lighting in selected areas.
  - Ability to perform energy accounting by displaying/recording electrical and natural gas flows.
- Passive energy consumption reduction strategies, such as increased insulation and isolation of temperature controlled and ambient spaces and increased equipment capacities to reduce duty cycles, should be utilized to the best advantage of the facility.

## **Pollution Control**

- Mechanical systems designs shall insure that airborne and waterborne contaminant emissions will meet all applicable codes and regulations.
- The percentage of air re-circulated into the occupied spaces of the facility should take ASHRAE recommendations into account to avoid "sick building syndrome" and other undesirable effects associated with stagnant air.

# SITE AND BUILDING REQUIREMENTS

---

## **Mechanical/Equipment Rooms**

- The mechanical discipline should provide guidance to the architect concerning the size and location of mechanical and equipment rooms and utility chases.
- Mechanical room sizing should take exchanger tube and air filter removal, as well as other common maintenance activity clearance requirements, into account as well as space and clearance required by ASHRAE and building codes, and the recommendations of the design basis equipment manufacturer should also be taken into account.
- If computer controls are used in mechanical/equipment rooms, the temperature in the space must be maintained in conformance with the control manufacturer's requirements.

## **ELECTRICAL**

The electrical design should address the following issues. These issues are not meant to represent the full extent of electrical involvement, and are only intended to convey basic functional requirements in an effort to facilitate coordination during detailed design. Refer to "CNG Impacts" later in this chapter for additional requirements.

### **Power**

- The site electric service voltage shall be coordinated with the power utility early in the detailed design. The electrical engineer should provide the architect with direction concerning the form, space requirements, and site impacts of the transformer and service entrance.
- In most cases, motors larger than 1/2 HP should be supplied 480 VAC, 3-phase or 208 VAC, 3-phase if 480 VAC is not available.
- Dedicated circuits and conduit connections should be provided throughout the facility for computer terminals.
- A dedicated circuit, 120 VAC convenience receptacle should be provided at each telephone terminal backboard.
- Spare capacity (50%) should be provided at all panel boards and switchboards.
- Surge suppression equipment should be provided either at the panel boards from which isolated ground receptacle circuits originate or individually at the appropriate outlet.
- A 90-minute battery backup system should be provided for the following items:
  - Radio and dispatch system.
  - Fire alarm and other fire protection and security systems.
  - Exit lights.
  - Telephone PBX
  - Computer Server/Data/Technology Rooms
- Computers should be connected to battery powered UPS packages with surge protection.

# SITE AND BUILDING REQUIREMENTS

---

- Rack mounted equipment within telecom rooms should be connected to battery powered UPS packages with surge protection.
- All electrical equipment should be suitable for the area classification of the area for which it is designed to be installed.
- All wall outlets and disconnects should be labeled with panel locations.
- Removable traffic bollards should protect the transformer and service entrance equipment.
- The main distribution system voltage should be 480/277 volts, 3 phase, and 4-wire grounded neutral with a 4-wire fault system that meets or exceeds the National Electrical Code requirements.
- Circuit breakers in the main switchboard should have ground fault protection set to trip before the main circuit breaker as well as solid state trip devices with adjustable long time and short time settings.
- Distribution of branch circuits and feeders should take the application of emergency power and zone electrical shutdown requirements into account.

## **Emergency Generator**

- An emergency generator should be sized to accommodate all fuel operations and vehicle lifts and lighting in the Maintenance Facility at a minimum. The generator should be connected to the main distribution system in such a manner as to promote maximum flexibility for utilizing emergency power.
- The emergency generator location should be determined during facility layout finalization. It should be close to the electrical service equipment, will require an outlet for hot exhaust gasses, and will require ample intake and ventilation air.
- Due to the noise and heat from the engine, the generator should be isolated from facility occupants.
- The components to be connected to the emergency generator should be determined during the detailed design.
- An automatic transfer switch should transfer the load from utility power to the engine generator after the engine gets up to speed and the generator up to frequency.
- The emergency power system will be composed of both uninterruptible loads and interruptible loads. Uninterruptible loads are those that must remain operational due to a life safety issue or is of a critical nature or in the case of some computers, where unwanted data loss or damage may occur. Interruptible loads are those than can tolerate a momentary interruption of power while power is being transferred by the automatic transfer switch.
- Regulatory approval and permits to construct/operate the emergency generator shall be provided prior to ABQ Ride acceptance and operation.

# SITE AND BUILDING REQUIREMENTS

---

## General Lighting Types and Lighting Levels

- \* All lighting levels shall be equal to those suggested by the Illuminating Engineers Society (IES) Handbook and as required by the City.
- \* **Office Light Fixture:** 50 FC. Use daylight fluorescent or LED lamps with energy efficient ballast and parabolic reflectors. Fixture mounted in acoustic ceiling tile grid. 3 lamp fixture capable of being switched for either 1 lamp on or all three lamps on.
- \* **Office Light Fixture Dimmable:** 50 FC to 2 FC. Dimmable can light with compact florescent or LED lamp capable of being dimmed with no flickering or discernable noise (hum) from fixture. Fixture recessed in ceiling.
- \* **Service Light Fixture - Shop:** 50 FC. Fluorescent, Induction or LED lamps with energy efficient ballast and acrylic diffuser or lamp protective metal grid diffuser. Fixture mounted in acoustic ceiling tile grid or surface mounted to exposed structure. 3 lamp fixture capable of being switched for either 1 lamp on or all three lamps on.
- \* **Service Light Fixture – Utility spaces:** 20 FC. Fluorescent or LED lamps with energy efficient ballast and acrylic diffuser or lamp protective metal grid diffuser. Fixture mounted in acoustic ceiling tile grid or surface mounted to exposed structure. 3 lamp fixture capable of being switched for either 1 lamp on or all three lamps on.
- \* **Service Light Fixture – Storage rooms:** 20 FC. Fluorescent or LED bulb. Fixture mounted in acoustic ceiling tile grid or surface mounted to exposed structure. Single light fixture.
- \* **Waterproof service light fixture –** 20 FC. Fluorescent or LED lamps with energy efficient ballast and acrylic diffuser. Fixture surface mounted to exposed structure. 3 lamp fixture capable of being switched for either 1 lamp on or all three lamps on.
- \* **Wet location sealed light fixture –** 30 FC. Fluorescent, Induction or LED lamps with energy efficient ballast and acrylic diffuser. Fixture recessed mounted in ceiling / soffit or surfaced mounted to exposed structure. 3 lamp fixture
- \* **Wet location sealed fixture w/ diffusers –** 30 FC. Fluorescent, Induction or LED lamps with energy efficient ballast and indirect reflector or acrylic diffuser. Fixture recessed mounted in ceiling. 3 lamp fixture.
- \* **Indirect light fixture over mirror –** 30 FC. Fluorescent or LED lamps with energy efficient ballast and indirect reflector. Fixture recessed mounted in ceiling. 3 lamp fixture.
- \* **High Bay Fixture –** 70 FC. High output fluorescent, Induction or LED lamps with energy efficient ballast. Lamp protection by either clear lamp wrap or impact resistant diffuser. Fixture surface mounted or suspended from exposed structure.
- \* **Waterproof High Bay Sealed Fixture –** 70 FC. High output fluorescent, Induction or LED lamps with energy efficient ballast. Lamp protection by clear lens. Fixture surface mounted or suspended from exposed structure.

# SITE AND BUILDING REQUIREMENTS

---

- \* **Explosion proof sealed fixture w/ diffusers** – 50 FC. Fluorescent, Induction or LED lamps with energy efficient ballast and indirect reflector or acrylic diffuser. Fixture recessed mounted in ceiling. 3 lamp fixture.
  - \* **Task Light – Shops** – 100 FC. High output fluorescent or LED lamps with energy efficient ballast. Fixture surface mounted to wall / column on swivel mounts to allow light to be direct / adjusted by users. Individually switched fixture controlled by user independent from room / space lighting.
  - \* **Task Light – Wash Bay** – 100 FC. High output fluorescent, Induction or LED lamps with energy efficient ballast. Sealed waterproof fixture surface mounted to wall / column on swivel mounts to allow light to be direct / adjusted by users. All tasks light in Chassis Wash controlled by single switch and independent from room / space lighting.
  - \* **Site lighting fixture – Agency Vehicle parking, circulation, and Agency Service areas.** 10 FC. Metal halide, Induction or LED lamps with energy efficient ballast. Pole mounted or surface mounted to building / structure walls. Sealed clear lens with adjustable light cutoff and “Dark Sky” compliant fixture.
  - \* **Site lighting fixture – Yard Storage, Employee and other parking and circulation areas.** 5 FC. Metal halide / High Pressure Sodium, Induction or LED lamps with energy efficient ballast. Pole mounted or surface mounted to building / structure walls. Sealed clear lens with adjustable light cutoff and “Dark Sky” compliant fixture.
- 
- Site lighting should be high-pressure sodium in exterior parking areas. Low-pressure sodium lighting is not acceptable.
  - Site lighting (exterior only) should be photocell controlled.
  - Light poles in the agency vehicle parking area should be limited to the perimeter if possible.
  - Site lighting shall comply with any local light pollution regulations.
  - Employee parking and agency vehicle parking areas must meet the City standard lighting levels for security and the prevention of accidents.
  - Office lighting levels shall be equal to those suggested by the Illuminating Engineers Society (IES) Handbook and the City’s standards.
  - Office areas shall use daylight fluorescent lamps with energy efficient ballast and reflectors.
  - Each bay shall be individually switched.
  - Lighting shall be suitable for the area classification in which it is designed to be installed.
  - Damp or wet location fixtures shall be labeled and used in appropriate locations.
  - Interior lighting should be controlled locally, but may be integrated to the Energy Management System in cases of single shift occupancies.
  - Extra lighting must be provided in all areas (exterior and interior) with vehicle movement at night.
  - Areas where television, CCTV, or personnel interface monitors (computer screens) are used should have non-glare lighting treatments.



# SITE AND BUILDING REQUIREMENTS

---

- All lighting levels shall comply with the City's established standards.

## **Fire Alarm and Detection**

- Fire alarm and fire/smoke detection devices shall be provided to monitor all areas in the facility.
- Fire alarm pull boxes shall be provided at exits.
- Activation of any detector or pull-box shall result in an audible/visual alarm throughout the facility, interact with the mechanical systems, interact with the fire protection/suppression system (ref. plumbing), and transmit an alarm signal via telephone line to a centrally located monitor and the local fire department monitoring station.
- The fire alarm control panel shall provide visual and audible annunciation for each initiating zone.
- The fire alarm control panel shall be located in a conspicuous place.
- All control panels shall be located in appropriate locations.

## **Telephone/Data Communications and Radio**

- A system of empty conduits, outlet boxes, and terminal backboard shall be provided in each building of the facility and between buildings.
- Conduits should include pulling ropes.
- Computer network wiring schemes shall be coordinated with the City.
- Most telephones should have long distance restrictions on outgoing lines.
- Equipment rooms with computerized equipment must have an appropriate HVAC system that monitors the proper temperature.
- Conduit for communication cabling shall be provided to all CCTV cameras.
- One-inch conduit shall be provided to every workstation to provide for up to 2 voice and 2 data lines per workstation. This shall be verified during detailed design.
- A minimum of 150% of actual requirements shall be provided for conduit between buildings to accommodate future growth and spares.
- Only gel fill cabling shall be used for feed cabling between buildings and from closet to closet.
- Current cabling technology shall be used.

## **Paging/Public Address System**

- A paging/public address system shall provide service to all offices, shops, repair bays, and outdoor work areas around the maintenance building and vehicle parking area.
- System speakers shall be of a type suitable for areas of high ambient noise.
- The control equipment shall be complete with provisions to permit interfacing with the telephone system to allow origination of paging from telephone instruments by dialing an assigned number.
- The volume level of individual speakers shall be adjustable without sacrificing system performance.

# SITE AND BUILDING REQUIREMENTS

---

## PLUMBING

The plumbing design should address the following issues. These issues are not meant to represent the full extent of plumbing involvement, and are only intended to convey basic functional requirements in an effort to facilitate coordination during detailed design.

### **Plumbing and Piping Systems**

- The following piping systems may be incorporated within buildings, as applicable:
  - Domestic Hot and Cold Water (HW and CW)
  - Fire Protection Water
  - Sanitary Recyclable and Vent
  - Industrial Recyclable Water
  - Industrial Waste (IW)
  - Roof Drainage
  - Storm Drainage
  - Compressed Air (CA)
  - Automatic Transmission Fluid (ATF)
  - Chassis Grease (CG)
  - Compressed Natural Gas (CNG)
  - Engine Coolant (EC)
  - Engine Oil (EO)
  - Gear Oil (GO)
  - Hydraulic Oil (HO)
  - Preservation Oil (PO)
  - Recyclable Oil (RO)
  - Recyclable Coolant (RC)
  - Fuel Gas/Low Pressure Natural Gas
  - Vehicle Wash Water
  - Diesel Fuel (DF)
  - Diesel Exhaust Fluid (DEF)
  - Unleaded Gasoline (UG)
  - Windshield Washing Solution (WS)
  - Waste Oil (WO)
  - Waste Coolant (WC)
- Piping which contains soil-contaminating fluids shall not be direct buried in earth.
- Piping which is required to communicate with services across floors and vehicle traffic areas should be routed in trenches as described in the structural section.

# SITE AND BUILDING REQUIREMENTS

---

- All piping should be readily accessible and available for visual inspection.
- Fuel gas/low pressure natural gas house line to be tested for inspection.
- The plumbing discipline should provide the structural discipline with trench width and turning area requirements with attention given to wrench clearances between fittings and pipes where appropriate or necessary for safe maintenance practices.
- The preferred methods for supporting pipes shall be detailed along with their arrangement and routing.
- Piping supports shall allow for the possible modest addition of future services and piping.
- Each plumbed system shall have shut-off valves overhead.
- All piping sizes should be based on maximum expected flows with an appropriate fouling allowance.
- A set of pipe specifications shall be developed such that at least one specification exists for each fluid service with design pressures and temperatures exceeding the expected operating pressure and temperature extremes of the system in question. NOTE: Each fluid service does not require its own pipe specifications. The pipe specification should detail the material, design conditions, suitable valves and fittings in the appropriate size ranges, minimum pipe wall thickness, and required insulation, if any.
- Pipe covering is required for domestic hot water.
- Industrial recyclable water must go to an oil/water separator.
- Where required by code, piping shall have secondary containment with leak detection.

## Plumbing Fixtures

- All plumbing fixtures, where applicable, should be of a water saving, low flow design and be consistent with the client's standards.
- Water closets should be wall-hung, flush valve type.
- Urinals in maintenance areas shall be wall-mounted, durable, low maintenance type.
- Hand washing stations shall be provided in shop areas. Consider use of touchless faucet activation device. Hand washing stations shall be trough type, stainless steel sinks with gooseneck faucets, and long handles.
- Showers for men and women shall be individual type.
- Eyewash and safety showers shall be located in hazardous areas and must be connected to the sanitary sewer.
- Standard stainless steel paper towel dispensers and hand dryers shall be provided in restroom facilities.
- All drainage shall have adequate slope towards the drainage points.
- Trap primers shall be used as required by local codes and shall be installed on lines with a reasonable expected frequency of operation.

# SITE AND BUILDING REQUIREMENTS

---

- Exterior hose bibs shall be key-type and of the "freezeless" variety.
- Water hammer arrestors should be properly applied to the system.
- Use of instant-on electric water heaters should be considered for restroom facilities without showers.
- Flush valve handles on handicapped closets to be located the on wide side of the stall.
- Use of large "paddle" handles on fixtures (water closets, urinals, and hand washing faucets) should be considered.

## Drains

- All floor/area drain piping should be sized based on the maximum expected flow loading with a generous allowance for fouling due to gravity flow velocities.
- Drain grates and frames shall be cast iron.
- There shall be no drains in lubricant containment areas.
- Drains from maintenance areas shall pass through adequately sized oil/water separators.
- Some areas such as lift pits and vehicle wash require special drains, traps, and sumps. These components should be identified and coordinated early in the detailed design.
- Drains should be located away from maintenance activities, where possible, so as not to impede movement of toolboxes and portable equipment.
- Vehicle wash water must connect to an oil/water separator, unless the treatment plant design and drain configuration address this issue.
- All trench drains must connect to an oil/water separator, unless the treatment plant design and drain configuration address this issue.
- Outflow from oil interceptor shall connect to the sanitary sewer.

## Compressed Air System

- The compressed air system shall have a "loop" distribution system.
- Compressed air should be provided to all maintenance work areas and to other designated locations.
- Compressed air drops should consist of the following components: ball cut-off valve, filter, regulator with gauge, lubricator, 1/4 inch quick disconnect, and a 6 inch drip leg with automatic drains.
- Compressed air should be suitable in quality, quantity, and pressure for tool operation, including pneumatic engine starters, and tire pressurization. Simultaneous use of tools may occur in particular areas.
- Instrument and/or breathable air should be provided for equipment as applicable.
- The compressed air system shall have appropriately sized air receivers located in the compressor room. The receivers shall have automatic drains.
- All branch lines for the compressed air header shall exit from the top of the header, except drip legs to condensate drain traps which shall exit from the bottom.

# SITE AND BUILDING REQUIREMENTS

---

- All lines, including main header, shall be sloped to drain to drip legs with condensate drain traps.
- Designer shall evaluate cost, reliability, and benefits of regenerative, refrigerated, and combination refrigerated and deliquescent air dryers to obtain compressed air with a suitable pressure dew point to prevent condensation under winter ambient design conditions.
- A pressure switch shall be mounted in the main air header and shall activate an audible and visual alarm when the switch detects pressure at or below 90 PSI.
- Quick connect fittings for different services, such as lubricated air, paint/blast air, and breathing air shall be color-coded and be non-interchangeable.
- A separator and filter shall be mounted between the air receiver and the air dryer.
- The air dryer, as well as the upstream separator and filter, shall be designed to handle the maximum surge flow from the receiver or the compressor rated flow, whichever is greater.
- All receivers shall be equipped with automatic condensate drain traps that shall discharge to the industrial recyclable system.
- All valves in the compressed air system should be of the ball-type.
- A fresh air breathing system shall be provided in each paint booth.

## Liquid Bulk Storage/Distribution

- The most economical method of purchasing and storing liquid consumables is in bulk. Recyclable liquids can also be handled in bulk. Storage capacities that are to be provided at the facility are listed under the appropriate space in the Functional Requirements section.
- Fuel tanks and fuel delivery piping shall be equipped with leak detection and alarm and automatic gauging devices. Alarm location shall be identified during detailed design. Leak detection and alarm equipment must be computer controlled with compatible connection to the City network.
- Each tank will be separately vented at a safe distance from grade and from site facilities and equipment.
- All tanks containing environmentally hazardous materials should be of the double wall type, thus providing secondary containment in the event of inner wall failure. A leak detector should be located in the annulus between the inner and outer shells.
- The facility shall be provided with a central lubricant system. This system should provide a variety of lubricants to the appropriate location (refer to the Functional Requirements section) by utilizing the following components:
  - Air piston lubricant pumps; wall-mounted whenever possible.
  - Compressed air to operate lubricant system
  - Lubricant and fluid hose reel banks mounted overhead or on specially fabricated racks.
  - Bulk lubricant and fluid storage tanks and associated piping.
  - Lubricant and fuel dispensers.

# SITE AND BUILDING REQUIREMENTS

---

- The floor below the lubrication pumps and storage tanks should be a grating covered containment sump with a manually operated drainage valve normally closed except during wash down. Note that a containment sump is not required under double wall tanks.
- Air piston pumps should be used to transfer the lubricants listed in the Functional Requirements section.
- Noise from the pumps and lubrication system must be isolated from all mechanic work areas and adjacent spaces.
- All storage tanks should be equipped with relief valves or devices to protect from over or under pressure conditions.

## **Operating Pressures**

- Operating pressures of liquid consumables distributed throughout the facility via the central lubricant system shall be verified during detailed design to be compatible with the pressures generated by the pumps.

## **Fuel Management System**

- A fuel management system should be provided at the fueling area to monitor use of all fuels and lubricants dispensed.
- Consideration should be given to installation of a fully automated system, using radio frequency or similar data transfer techniques.
- Final installation details may vary based on the approved fuel management system manufacturer.
- The diesel fuel directed to the emergency generator should be monitored by the fuel management system and drawn from the main fuel island tanks if possible.
- Fuel management system performance during fire alarm situations should be addressed.
- Provisions for premature vehicle pull-out should be included in the design. Examples include breakaway hoses and traffic signals tied to the fuel dispenser solenoid.

## **Leak Detection/Inventory Monitoring System**

- Underground fuel storage tanks, pump/piping manholes, dispenser boxes and fuel supply piping will be equipped with automatic leak detection monitoring and alarm, automatic gauging/inventory monitoring and overflow monitoring and alarm.
- Bulk oil lubrication tanks will be provided with leak detection monitoring and alarm
- Leak detection/inventory monitoring system monitoring and alarm panel location will be identified during detailed design. .

# SITE AND BUILDING REQUIREMENTS

---

## **Fire Protection System**

- Fire protection systems such as automatic fire sprinklers, standpipes, fire hose cabinets, and fire extinguishers shall be designed, as required, for maximum safety in accordance with the requirements of all applicable codes and the local Fire Department for each hazard occupancy.
- Fire hydrants and pump connection locations shall be coordinated with the local Fire Marshall or other appropriate local authority for the type and class of fire fighting equipment serving the site.
- The building fire alarm shall shut down process fluid flow to the building.
- The fire alarm system shall have the option for testing individual alarm function.
- Provide map of entire fire suppression system, installed at the Control Panel location. Also, provide evacuation route maps, behind glass, in appropriate locations.
- A FM 200 dry chemical system shall be used in computer equipment rooms.

## **ALTERNATIVE FUEL IMPACTS**

Lighter than Air Fuels will impact the following building systems:

- Gas Detection
- Exhaust Ventilation
- Make-up Air
- Electrical
- Structural/Architectural

Note: The additional requirements to these building systems listed below are for references only and shall be modified based on specific fuel type selected.

## **Gas Detection**

- Provide a gas detection system to detect the presence of methane at 20% and 40% of the lower explosion limit (LEL) by volume.
- Gas detection systems must be fail-safe. Most installations today are not.
- The system shall be comprised of infrared combustible gas sensors, audible and visual alarms and control panels. Sensors shall be installed in accordance with manufacturer's recommendations within 18 inches of the roof wherever a methane gas hazard could exist.
- Provide manual dead-man switches in all maintenance and fueling areas to allow personnel in the area to activate the alarm system in the event of a gas release.
- Provide calibration tubes to floor level to facilitate periodic calibration of the sensors.
- Provide interlocks to open all or some of the outside overhead doors.
- Provide interlocks to start emergency exhaust ventilation.
- Shunt trip power to all non-emergency systems.

# SITE AND BUILDING REQUIREMENTS

---

- Provide audible and visible alarms strategically located so that all personnel in the affected area will be notified.
- Sensor systems must be rated Class 1, Division 1, Group B.
- Fire alarm systems should be explosion-proof.

## Exhaust Ventilation

- Provide continuous ventilation of not less than 4 air changes per hour (ACH) in all bus areas. An exhaust fan should be located at the high point of each pair of bays to minimize the number of fans and still maintain proper ventilation.
- Provide emergency exhaust of an additional 6 ACH (10 total) to be activated by the gas detection/alarm system. The exhaust system may be provided with two-speed fans with the higher speed activated by the gas detection/alarm system.
- All exhaust fans should be non-sparking type.
- All motors in the exhaust system should be direct drive and Division 1 rated.
- Exhaust fans should be located at the high point of building (or area). Pockets should also be ventilated.
- All exhaust fans should be on the emergency stand-by power system.
- A vent gas collection system, for buses parked in the maintenance building, is recommended. The development of such a system should be coordinated with the vehicle manufacturer. All natural gas vents on the vehicle should be manifolded to a single exit point above the vehicle roof exterior. In the event of gas release from a vehicle inside the building, vapors would be collected and drawn to the vent gas collection system and routed for release above the building roof exterior.

## Make-up Air

- Provide continuous tempered warm make-up air during the heating season. (Hydronic floor heat is a very effective and safe method of heat for natural gas facilities, however, this approach may be cost prohibitive).
- Provide approximately 1 ACH less than the exhaust rates to maintain negative pressure in repair bay areas.
- Shop heaters should utilize heating by hot water or other means with safe skin temperatures. Designating a hazardous location near the roof is not recommended, as this would require completely upgrading wiring that portion of the facility. It is recommended that all sparking and ignition risks above the vehicle roofline should be addressed - without requiring Division 1 or Division 2.
- Split make-up air between floor and ceiling (perhaps a 50/50 split) to ensure that the ceiling space is fully swept.



# SITE AND BUILDING REQUIREMENTS

---

## Electrical

- All rated equipment in the repair bays should be Class 1, Division 1 or 2 (as applicable), Group B.
- All equipment above the vehicle to be addressed to reduce sparking risk. Designating a hazardous location near the roof is not recommended, as this would require completely rewiring that portion of the facility. It is recommended that all sparking and ignition risks above the vehicle roofline should be addressed - without requiring Division 1 or Division 2. The temperature of equipment should be a maximum of 80% of 1,000 degrees F (800 degrees F) per NEC.
- All lighting in repair bays should be sealed. Designating a hazardous location near the roof is not recommended, as this would require completely rewiring that portion of the facility. It is recommended that all sparking and ignition risks above the vehicle roofline should be addressed - without requiring Division 1 or Division 2. The temperature of lighting should be a maximum of 80% of 932 degrees F (745 degrees F) per NEC.
- Sealed light fixtures will reduce the risk of igniting the natural gas. If the lighting is sealed, it allows more time for the ventilation system to remove the gas before it is present in a flammable mixture near exposed electrical connections. Note that lamps must be protected to avoid possible breakage causing a spark/electrical flash.
- Provide shunt trips to remove power from all tools and non-safety loads in a gas detection event.

## Structural/Architectural

- Eliminate pockets (where possible) where gas could collect.
- Utilize open roof framing to facilitate air movement and to eliminate pockets.
- Utilize pitched roofs where possible.
- Provide bulkheads and/or separation walls and doors between vehicle and non-vehicle areas.
- Consider utilizing fast-acting, rubber, coiling doors with breakaway feature to provide for pressure relief at all exterior overhead door locations.
- Door motors should be Division 1 rated and on the emergency stand-by power system.
- Roof awnings (or overhangs) should be avoided or ventilated to prevent accumulation of gases.
- Fall arrest systems should be provided above vehicle repair bays to allow mechanics to safely work on the top of the vehicle. The fall arrest systems should cover the length of the vehicle. At least two bays should be provided initially.

# **SITE AND BUILDING REQUIREMENTS**

---

## **SECURITY**

A separate workshop should be conducted to verify and finalize security requirements outlined in the Design Criteria.

### **Fencing**

- The entire yard area must be secured (with fence, walls, and/or buildings).
- Fenced areas will need control gates at access/egress points. Gates will be accessed by key card and will be connected to the City current standard security card access system via the City network.

### **Lighting**

- Sufficient security site lighting should be provided at building exteriors, at perimeter fencing locations, and in employee and vehicle parking and driveway areas.
- Security lighting should not adversely impact surrounding property.

### **CCTV**

- The CCTV system should be routed to the security office.
- Cameras, at a minimum, should be provided at the front of all bay doors, employee parking lot, vault pull, shipping and receiving areas, the reception desk, vehicle parking area, and at any money handling location.
- Cameras in employee parking shall be stationary with panning capability.
- A non-switched electrical source shall be provided to the CCTV system.
- Specific CCTV camera locations shall be identified early in the detailed design process and shall be coordinated with security.

### **Other Security Considerations**

- An electronic security system shall be provided for the entire facility. The system specifications must be coordinated with the City during detailed design.
- A guard station is required at the vehicle entrance/exit.
- All security systems must be carefully coordinated with the City during detailed design.
- Vegetation should be thorny where possible and should not provide hiding places.
- Panic buttons with a two-way speaker system should be provided in the employee parking area.
- Coordinate with local law enforcement during detailed design.
- From a safety and security standpoint, it would be ideal if access to the site were restricted.

# SITE AND BUILDING REQUIREMENTS

---

## **SIGNAGE AND GRAPHICS**

Proper signage and graphics throughout the facility are important. Because of the complex industrial workflow, safety regulations, mixing of vehicle and pedestrian traffic, employee performance codes, and the requirements of the Americans with Disabilities Act, high quality graphics that promote a positive organizational image are important. Properly designed graphics will not only add to the aesthetics of the facility, they will also assist employees in performing their assigned tasks more efficiently and safely. Specific signage and graphics requirements including safety, directional, informational, traffic signs, and pavement markings should be developed during detailed design to be consistent with the City's standards.

- All exposed pipes, conduits, and major lines in the maintenance areas should be color coded for easy identification. Color-coding should be accomplished with full painting if possible, or color-banding at a minimum, and meet the City's standards.
- All reel banks shall be labeled.
- Design of a monument sign shall be by the City.

## **WASTE HANDLING**

- Appropriate space for storage and handling of waste must be provided. Inadequate storage space can result in an unsightly mess that is difficult to control. There are four types of materials for which storage must be provided.
  - Trash: This consists of the facility's trash and waste products which cannot be recycled. Provide a screened area for one 40 yard dumpster.
  - Scrap Metal: Ferrous and non-ferrous scrap metals. A contract scrap dealer may provide containers for collection and removal, but adequate space and vehicle circulation must be considered when locating scrap areas. Provide a canopy covered area for one 20 yard dumpster.
  - Recyclable: Bins may be provided for recycling steel, brass, copper, glass, aluminum, paper, and other selected materials (including tires and oil filters). Provisions for these should be included in the facility design.
  - Hazardous Materials: Many items are now considered hazardous materials and must be dealt with in special ways. Some of these items are: tires, batteries, paint, solvents, light bulbs and tubes, and contaminated oil filters. Containers for hazardous materials may be provided for storage and collection, but adequate space and vehicle circulation must be considered when locating these containers. Storage of hazardous materials must provide secondary containment.
- The central waste collection facility should be canopy covered to prevent water infiltration.

# **SITE AND BUILDING REQUIREMENTS**

---

## **FACILITY MAINTENANCE**

- Space for storage of Facilities Maintenance materials and equipment and for a crew work area must be provided at the facility.
- Storage space for janitorial supplies and equipment must be provided in each area.
- Space must be provided for charging batteries on floor scrubbers, carts, and manlifts.
- A floor sink with hot and cold water is required in each janitorial room.



---

**CONCEPT DESIGN**



## INTRODUCTION

This section describes the proposed site layouts at the Yale Maintenance Facility site as designed based on the design criteria, existing conditions, and the design team's discussions with ABQ Ride staff during a workshop conducted the week of April 6, 2015.

## CURRENT FUNCTIONS

### Maintenance Facility

The existing Maintenance Facility serves 40' fixed route buses only. Due to size constraints, it is unable to serve 60' articulated coaches. The facility houses paint and body shops, a component rebuild / unit shop, and parts storage.

### Fuel Island

The existing fuel island serves provides diesel and CNG fueling via three canopy covered lanes with a central money counting room for vault pulls and a service staff office and restroom.

### Wash Building

The existing wash building houses a 4-brush automatic washer with a nonoperational water reclaim unit and a chassis wash lane served by a high pressure hot water spray wash unit.

### Operations Building / Sun Van Building

The Operations Building is a two story facility that currently houses Yale's operations staff and driver areas along with ABQ Ride's IT department, Facility Maintenance offices, a shared use fitness room, and a great deal of storage / vacant space. The Sun Van building is in disrepair and will be demolished in all options.

### Garage Facilities

The "New" Garage is currently used for parking vehicles in a semi enclosed state due to being filled over capacity. The "Old" garage serves as overflow storage for Vehicle Maintenance, Facility Maintenance, and NRV vehicles.

*Note that the Operations Building and Sun Van Building are not part of this study but are included at a basic programming level to reflect their impact on the site layouts.*

# CONCEPT DESIGN

---

## EXISTING YALE SITE LAYOUT

The drawing on the following page depicts the Yale Maintenance Facility's current site layout.

This layout was created based upon a combination of existing drawings supplied by ABQ Ride staff, aerial photographs and mapping information obtained from online sources, and revisions based on the PB design team's on-site observations and discussions with ABQ Ride staff.

## EXISTING FLEET

78      FIXED ROUTE 40' BUSES

78      TOTAL

20      NON-REVENUE VEHICLES



# CONCEPT DESIGN

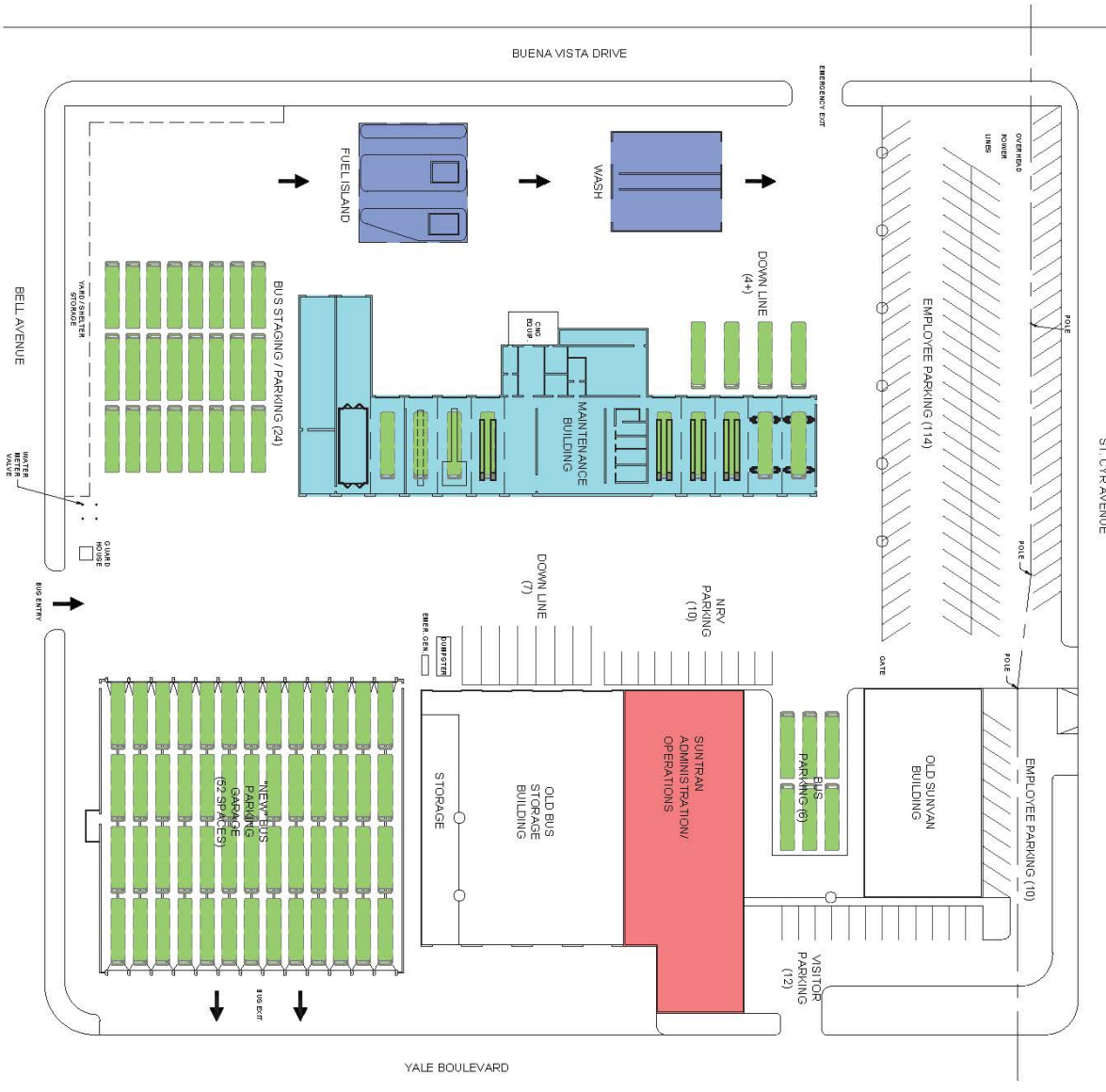

FLEET	
37	FIXED ROUTE 40' DIESEL HYBRID
41	FIXED ROUTE 40' CNG
78	TOTAL
20	NRV

LEGEND	
[Green Box]	FIXED ROUTE 40'
[Blue Box]	FIXED ROUTE 60'
[Yellow Box]	PARATRANSIT 25'
[Red Box]	VEHICLE MAINTENANCE OPERATIONS (GROUND)
[Light Blue Box]	OPERATIONS (ABOVE)
[Dark Blue Box]	FUEL & WASH
[Grey Box]	FACILITY MAINTENANCE

DRAWING NUMBER	DRAWING TITLE	<b>PARSONS BRINCKERHOFF</b> <small>16200 PARK ROW SUITE 300 NEWPORT, TEXAS 77460 TEL: (817) 805-0000 FAX: (817) 728-0000</small>	PROJECT TITLE	PROJECT NO.
X	EXISTING SITE		ABQ RIDE YALE MAINTENANCE FACILITY ASSESSMENT	33722A
			DRAWN BY	MM
			DATE	4/17/2015
			SCALE	22x94 1/32" 11x17 1/64"

# CONCEPT DESIGN

---

## EXISTING YALE MAINTNENANCE FACILITY FLOOR PLAN

The drawing on the following page depicts the Yale Maintenance Facility's current floor plan.

This floor plan was created based upon a combination of existing drawings supplied by ABQ Ride staff, aerial photographs and mapping information obtained from online sources, and revisions based on the PB design team's on-site observations and discussions with ABQ Ride staff.

With remediation, the existing facility is capable of servicing ABQ Ride's 40' fixed route vehicles and paratransit vehicles. The building's existing footprint prohibits servicing 60' articulated buses. Additionally, the cost and footprint impact to remodel this existing facility to service larger vehicles is too high and impractical for proper site circulation, so adjustments to this facility to accommodate articulated buses have been ruled out for this study.

# CONCEPT DESIGN

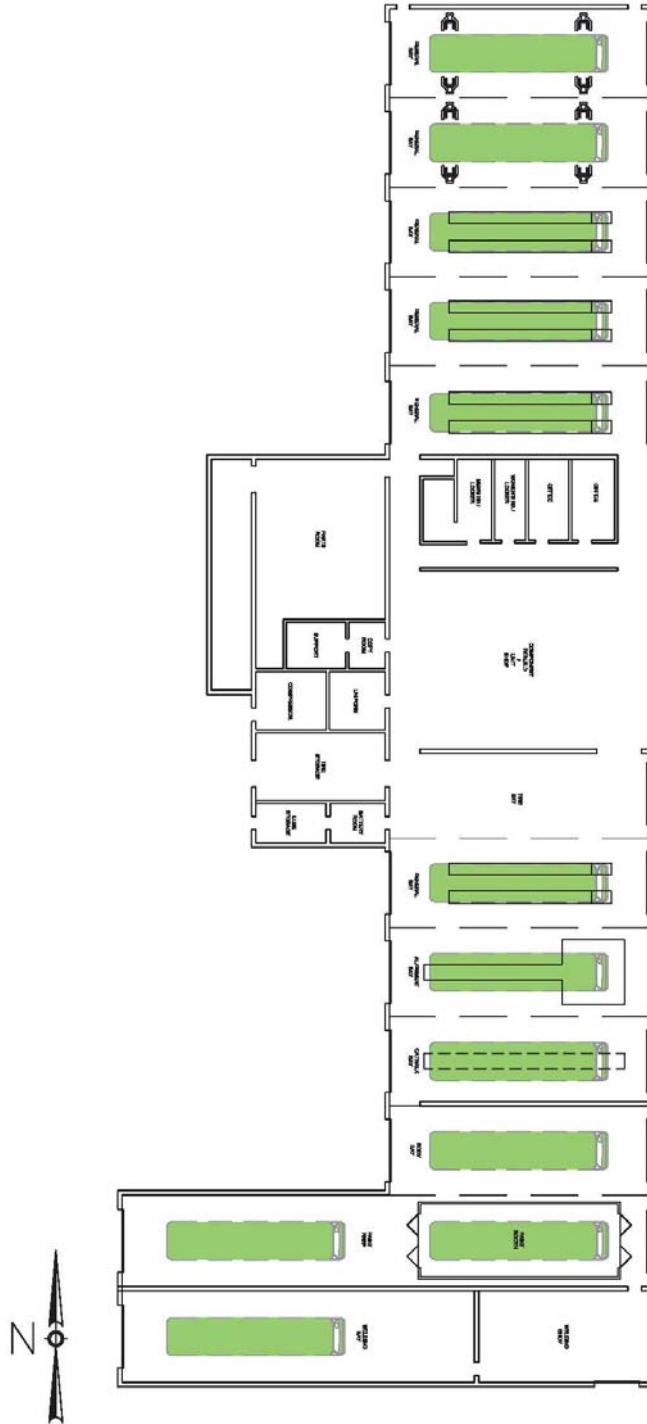

DRAWING NUMBER FP-X	DRAWING TITLE MAINTENANCE FLOOR PLAN (EXISTING)	<b>PARSONS BRINCKERHOFF</b> <small>ARCHITECTURAL AND ENGINEERING 7500 CENTRAL AVENUE, SUITE 100 DENVER, COLORADO 80231 TEL: (303) 733-8100 FAX: (303) 733-8104</small>	PROJECT TITLE ABQ RIDE YALE MAINTENANCE FACILITY ASSESSMENT	PROJECT NO. 22722A DRAWN BY MM DATE 4/7/2016 SCALE 3/8"
------------------------	--	---	--	--

# CONCEPT DESIGN

---

## PROPOSED 40' FIXED ROUTE MAINTENANCE FACILITY FLOOR PLAN

The drawing on the following page depicts the Yale Maintenance Facility's layout if designed to service 40' fixed route buses and paratransit vehicles.

This floor plan was created based on the design criteria and discussions with ABQ Ride staff.

This layout will allow flexibility to service both 40' buses and paratransit vehicles while greatly improving the functionality and efficiency of the Yale site and maintenance facility.

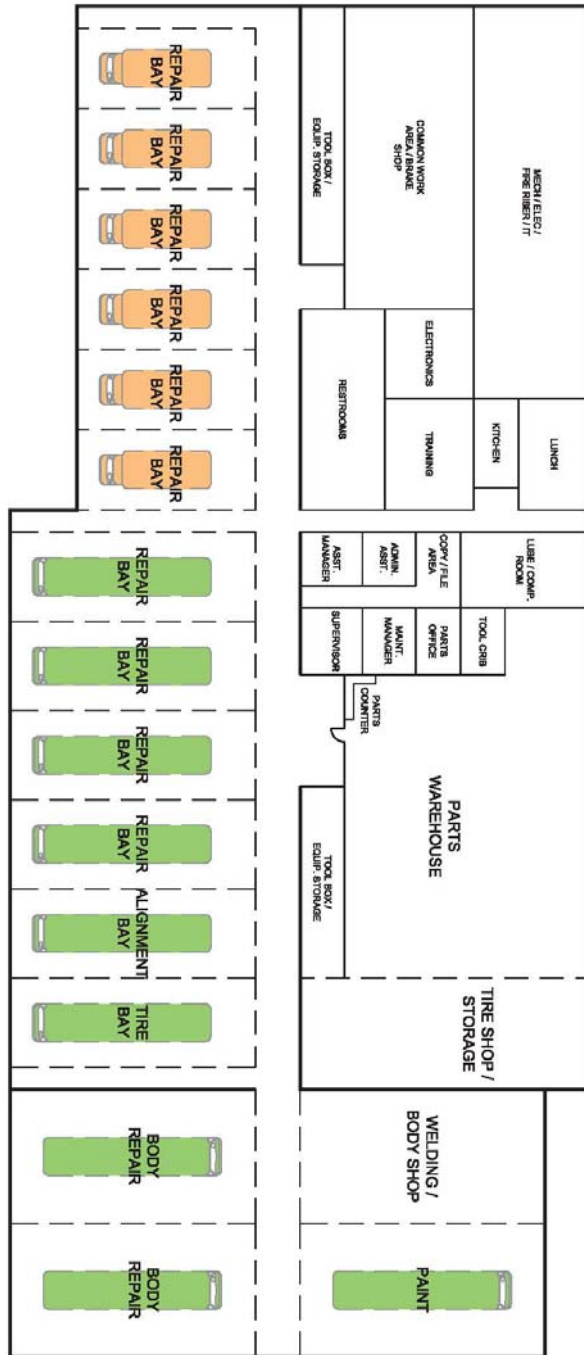

FLOOR PLAN USED IN OPTIONS 1 & 3

DRAWING NUMBER <b>FP-1</b>	DRAWING TITLE <b>MAINTENANCE FLOOR PLAN (NEW - 40' BUS)</b>	<b>PARSONS BRINCKERHOFF</b> <small>CONCEPT DESIGN</small> <small>ARCHITECTURE, ENGINEERING, PLANNING</small> <small>700 WEST 17TH AVENUE</small> <small>DENVER, COLORADO 80202</small>	PROJECT TITLE <b>ABQ RIDE YALE MAINTENANCE FACILITY ASSESSMENT</b>	PROJECT NO.	32722A
				DRAWN BY	MM
				DATE	4/7/2016
				SCALE	3/8"

# CONCEPT DESIGN

---

## PROPOSED 60' FIXED ROUTE MAINTENANCE FACILITY FLOOR PLAN

The drawing on the following page depicts the Yale Maintenance Facility's layout if designed to service 40' fixed route buses, 60' fixed route buses, and paratransit vehicles.

This floor plan was created based on the design criteria and discussions with ABQ Ride staff.

This layout will allow the maximum flexibility to service any vehicle contained in ABQ Ride's fleet while greatly improving the functionality and efficiency of the Yale site and maintenance facility.

Note that all fixed route repair bays are sized to accommodate articulated buses. This is more bays for articulated buses than the projected articulated bus fleet would require, however, this configuration provides additional flexibility for scheduling maintenance activities.

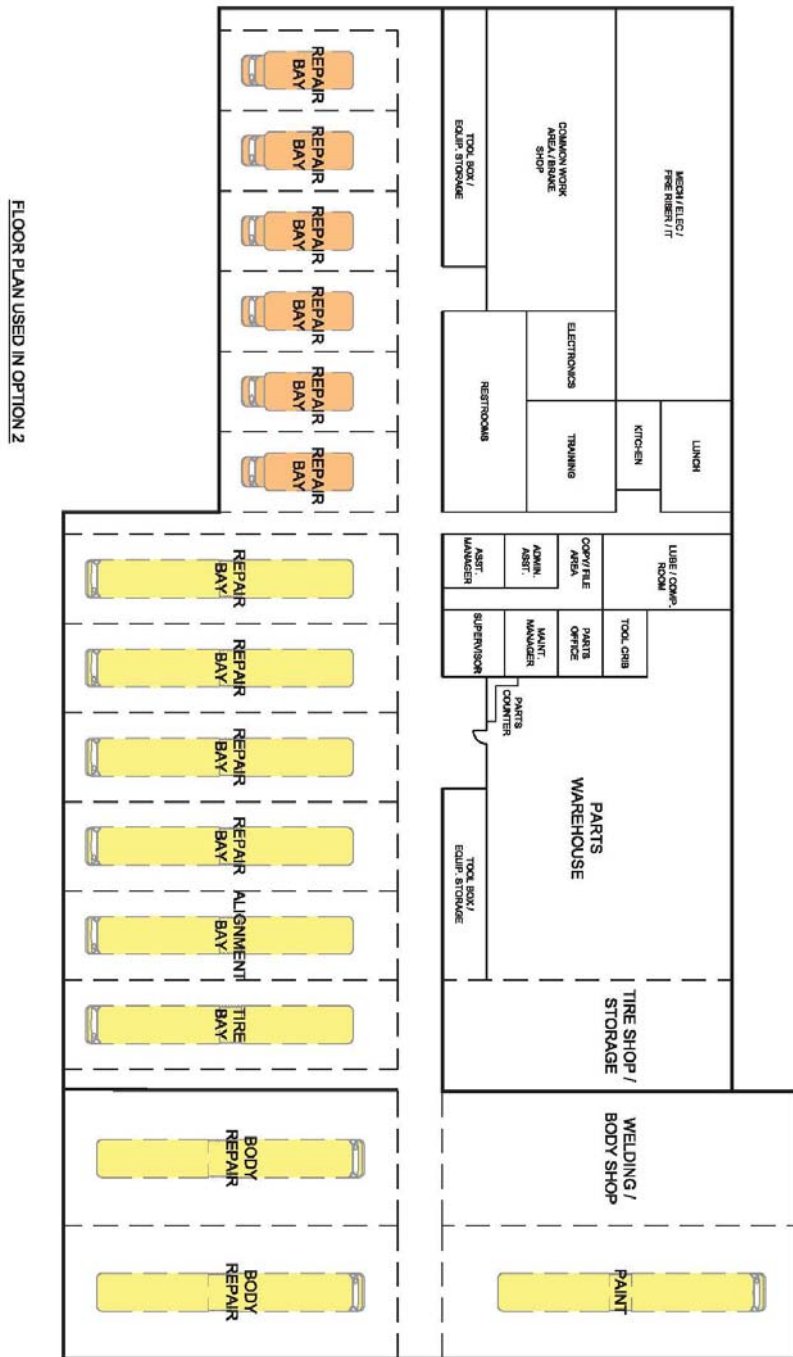

DRAWING NUMBER FP-2	DRAWING TITLE MAINTENANCE FLOOR PLAN (NEW - 60' BUS)	<b>PARSONS BRINCKERHOFF</b> <small>AN IRVING-CLOUD COMPANY</small> <small>10000 SANDHILL DRIVE, SUITE 1000</small> <small>IRVING, TEXAS 75039</small> <small>TEL: (972) 750-0000</small> <small>FAX: (972) 750-0000</small>	PROJECT TITLE ABQ RIDE YALE MAINTENANCE FACILITY ASSESSMENT	PROJECT NO.	32722A
				DRAWN BY	MM
				DATE	4/7/2016
				SCALE	3/8"

# CONCEPT DESIGN

---

## OPTIONS BREAKDOWN

The following design options were identified for the Yale Maintenance Facility Site. Three main options were identified by fleet mix with further site layout development.

- Option 1: Design Fleet of 40' Fixed Route Buses and Paratransit
- Option 2: Design Fleet of 40' and 60' Fixed Route Buses and Paratransit
- Option 3: Design Fleet of Paratransit only

Each of these options is then broken down further based on reuse of various existing facilities or orientation of a new Maintenance Facility on the site as shown:

- Sub-Option X: Reuse the existing Maintenance Facility
- Sub-Option E: New Maintenance Facility on the East portion of the site
- Sub-Option N: New Maintenance Facility on the North portion of the site

Each option is then further subdivided to show the impact of how Operations space is provided:

- Sub-Option A: Reuse the existing Operations Building
- Sub-Option B: Build a new stand-alone Operations Building
- Sub-Option C: Include a new Operations space above the Maintenance Facility

*Note that the existing Sun Van building is demolished in all design options.*



**THIS PAGE LEFT INTENTIONALLY BLANK**

# CONCEPT DESIGN

---

## OPTION 1(X)

### **Reuse Existing Facilities for 40' Fixed Route and Paratransit**

This option reuses the existing Maintenance, Fuel, Wash, Garages, and Operations buildings with a new Facility Maintenance Building located near the demolished Sun Van building.

Paratransit vehicles are added to the Yale Maintenance Facility's designed fleet responsibility and stored in the existing "Old" Garage and within newly striped yard parking

#### DESIGN FLEET

50	FIXED ROUTE 40' BUSES
70	PARATRANSIT VEHICLES
120	TOTAL

20	NON-REVENUE VEHICLES
----	----------------------

#### SITE ACCESS AND BUS FLOW

Vehicles continue to enter the site from Bell Avenue and circulate in a clockwise manner, which poses higher operational risks. Vehicles exit from the garages onto Yale Blvd. Circulation space is very limited with multiple staging areas occurring in or near drive lanes. Delivery vehicles must enter transit circulation for drop-offs.

#### MAINTENANCE

The existing Maintenance Building is reused. New maintenance and storage equipment is installed and the facility is renovated to bring it closer to the standards developed in the Design Criteria. Fixed Route 60' buses are unable to be accommodated.

#### OPERATIONS

The existing Operations Building is reused. The building is renovated to bring it closer to the standards developed in the Design Criteria.

#### FACILITY MAINTENANCE

A new Facility Maintenance Building is located in the northeast quadrant of the site in the space previously occupied by the demolished Sun Van Building.

#### FUEL

The existing Fuel Island is reused. New fueling and service equipment is installed and the buildings and canopy are renovated to bring them closer to the standards developed in the Design Criteria. Fixed Route 60' buses are unable to be accommodated.

#### WASH

The existing Wash Building is reused. A new bus washer and chassis wash equipment are installed and the building is renovated to bring it closer to the standards developed in the Design Criteria. Fixed Route 60' buses are unable to be accommodated.

#### BUS PARKING:

Fixed route 40' bus parking remains in the "New" Garage Building with the rear door unable to be closed due to size limitations. Paratransit vehicles are added to the site and parked in both the "Old" Garage Building and Paratransit parking in the yard south of the Maintenance Building. Wheelchair lifts cannot be operated in place.

#### EMPLOYEE / VISITOR PARKING

A total of 136 employee and visitor parking spaces are available. The existing lot to the north of the Maintenance Building separated by a fence and gate remains in place. Adjustments to the parking area near the demolished Sun Van Building are made to accommodate the new Facility Maintenance Building.

# CONCEPT DESIGN

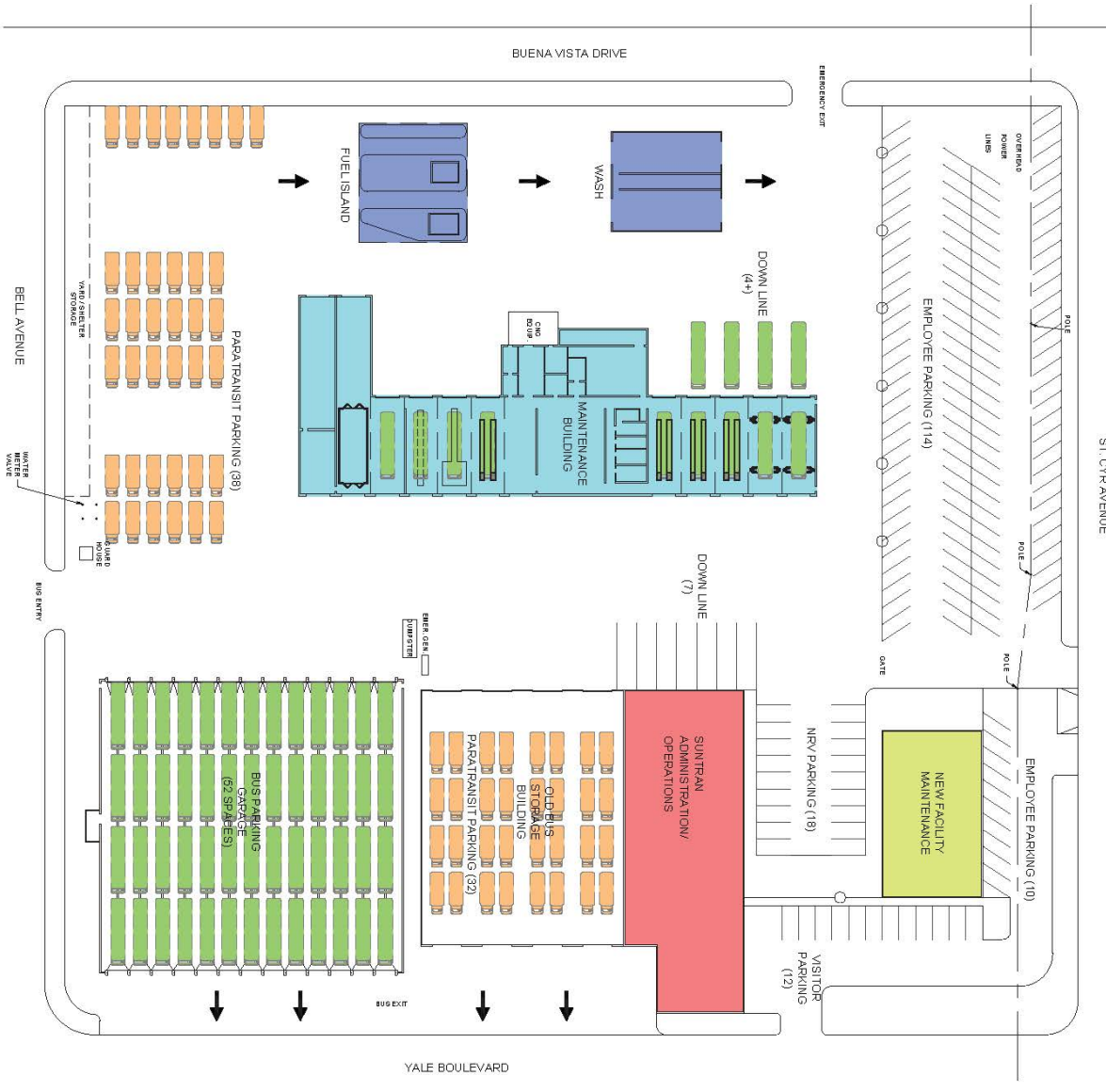

DESIGN FLEET	
50	FIXED ROUTE 40'
70	PARATRANSIT 25'
120	TOTAL
20	NRV

LEGEND	
[Green Box]	FIXED ROUTE 40'
[Yellow Box]	FIXED ROUTE 60'
[Orange Box]	PARATRANSIT 25'
[Light Blue Box]	VEHICLE MAINTENANCE OPERATIONS (GROUND)
[Red Box]	OPERATIONS (ABOVE)
[Blue Box]	FUEL & WASH
[Light Blue Box]	FACILITY MAINTENANCE

DRAWING NUMBER  1(X)	DRAWING TITLE OPTION 1(X) EXISTING FACILITIES	 <b>PARSONS BRINCKERHOFF</b> <small>16200 PARK ROW SUITE 300 DENVER, CO, 80202 TEL: (303) 750-0000 FAX: (303) 750-0004</small>	PROJECT TITLE ABQ RIDE YALE MAINTENANCE FACILITY ASSESSMENT	PROJECT NO.	33722A
				DRAWN BY	MM
				DATE	4/17/2015
				SCALE	22x94 1/32" 11x 17 1/64"

# CONCEPT DESIGN

---

## OPTION 1(E)A

### **New 40' Fixed Route Maintenance Facility (East) with Existing Operations Building**

This option constructs new 40' fixed route sized Maintenance, Fuel, and Wash facilities while demolishing the existing garages and reusing the existing Operations buildings with a new Facility Maintenance building located near the demolished Sun Van building.

Paratransit vehicles are added to the Yale Maintenance Facility's designed fleet responsibility and stored uncovered on the site with the new 40' fixed route bus parking layout.

#### DESIGN FLEET

50	FIXED ROUTE 40' BUSES
70	PARATRANSIT VEHICLES
120	TOTAL

20	NON-REVENUE VEHICLES
----	----------------------

#### SITE ACCESS AND BUS FLOW

The site is configured for vehicles to enter via Bell Avenue, circulate the yard in an ideal counterclockwise drive pattern for nightly service, and exit the site via Bell Avenue. A secondary exit is provided on Buena Vista Drive. Isolated access for deliveries and paint/body vehicle circulation is provided via Yale Blvd.

#### MAINTENANCE

A new Maintenance Building with 6 repair bays for 40' vehicles, 6 repair bays for paratransit vehicles, and paint and body repair bays for 40' vehicles is constructed on the southeast corner of the site.

#### OPERATIONS

The existing Operations Building is reused. The building is renovated to bring it closer to the standards developed in the Design Criteria.

#### FACILITY MAINTENANCE

A new Facility Maintenance Building is located in the northeast quadrant of the site in the space previously occupied by the demolished Sun Van Building.

#### FUEL

A new Fuel Island with 3 lanes and associated support spaces is constructed on the southern boundary of the site. New CNG equipment is installed in the southwest corner of the site.

#### WASH

A new Wash Building housing a 4-brush automatic wash system, chassis wash lane, and wash equipment spaces is constructed in line with the Fuel Island with adequate space to bypass wash.

#### BUS PARKING:

Fixed route 40' bus parking is located in the north of the yard with paratransit parking directly below it. All vehicles are parked in 14' spaces which allow for wheelchair lifts to be operated in place during pullout. All vehicles can be accessed by moving a maximum of 1 vehicle.

#### EMPLOYEE / VISITOR PARKING

A total of 160 employee and visitor parking spaces are available. A new lot to the north of the Maintenance Building and fully separated from transit vehicles is constructed west of the Facility Maintenance Building. Adjustments in the existing parking near the demolished Sun Van Building are made to accommodate the new Facility Maintenance Building.

# CONCEPT DESIGN

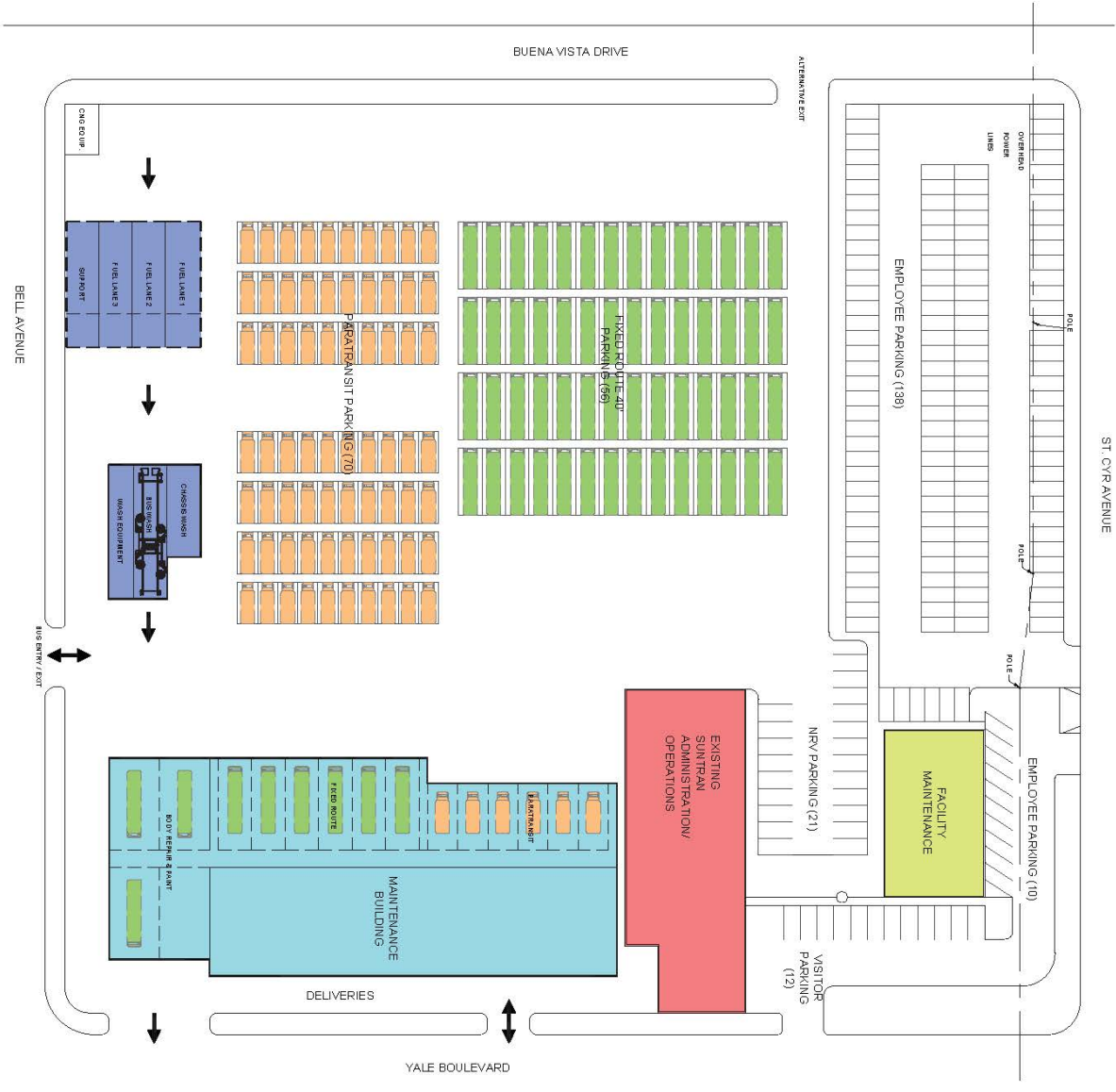

DESIGN FLEET	
50	FIXED ROUTE 40'
70	PARATRANSIT 25'
120	TOTAL
20	NRV

LEGEND	
[Green Box]	FIXED ROUTE 40'
[Yellow Box]	FIXED ROUTE 60'
[Orange Box]	PARATRANSIT 25'
[Light Blue Box]	VEHICLE MAINTENANCE OPERATIONS (GROUND)
[Red Box]	OPERATIONS (ABOVE)
[Blue Box]	FUEL & WASH OPERATIONS
[Light Green Box]	FACILITY MAINTENANCE



DRAWING NUMBER <b>1(E)A</b>	DRAWING TITLE <b>OPTION 1(E)A NEW FACILITIES EAST W/ EXISTING OPS</b>	 <small>16200 PARK ROW SUITE 300 DENVER, CO 80202 TEL: (303) 750-0000 FAX: (303) 750-0000</small>	PROJECT TITLE <b>ABQ RIDE YALE MAINTENANCE FACILITY ASSESSMENT</b>	PROJECT NO. 33722A DRAWN BY MM DATE 4/17/2015 SCALE 22x94 1/32" 11x17 1/64"
--------------------------------	--	--	---	---

# CONCEPT DESIGN

---

## OPTION 1(E)B

### **New 40' Fixed Route Maintenance Facility (East) with New Operations Building**

This option constructs new 40' fixed route sized Maintenance, Fuel, and Wash facilities while demolishing the existing garages and Operations building. A new stand-alone Operations building is constructed near the demolished Sun Van building and a new Facility Maintenance building is constructed adjacent to the new Yale Maintenance Facility.

Paratransit vehicles are added to the Yale Maintenance Facility's designed fleet responsibility and stored uncovered on the site with the new 40' fixed route bus parking layout.

#### DESIGN FLEET

60	FIXED ROUTE 40' BUSES
70	PARATRANSIT VEHICLES
130	TOTAL

20 NON-REVENUE VEHICLES

#### SITE ACCESS AND BUS FLOW

The site is configured for vehicles to enter via Yale Blvd, circulate the yard in an ideal counterclockwise drive pattern for nightly service, and exit the site via Yale Blvd. Secondary exits are provided on Buena Vista Drive and Bell Avenue. Isolated access for deliveries and paint/body vehicle circulation is provided via Yale Blvd.

#### MAINTENANCE

A new Maintenance Building with 6 repair bays for 40' vehicles, 6 repair bays for paratransit vehicles, and paint and body repair bays for 40' vehicles is constructed on the southeast corner of the site.

#### OPERATIONS

A new stand-alone Operations Building is constructed in place of the demolished Sun Van Building.

#### FACILITY MAINTENANCE

A new Facility Maintenance Building is constructed adjacent to the new Maintenance Building's north wall.

#### FUEL

A new Fuel Island with 3 lanes and associated support spaces is constructed in the northern portion of the yard. New CNG equipment is installed on the southern wall of the Wash Building.

#### WASH

A new Wash Building housing a 4-brush automatic wash system, chassis wash lane, and wash equipment spaces is constructed in line with the Fuel Island with adequate space to bypass wash.

#### BUS PARKING:

Fixed route 40' bus parking is located in the yard south of Fuel & Wash with paratransit parking directly above it. All vehicles are parked in 14' spaces which allow for wheelchair lifts to be operated in place during pullout. All paratransit vehicles can be accessed by moving a maximum of 1 vehicle.

#### EMPLOYEE / VISITOR PARKING

A total of 165 employee and visitor parking spaces are available. A new lot to the north of the Maintenance Building and fully separated from transit vehicles is constructed across the northern band of the site west of the new Operations Building.

# CONCEPT DESIGN



DESIGN FLEET	
60	FIXED ROUTE 40'
70	PARATRANSIT 25'
130	TOTAL
20	NRV

LEGEND	
[Green Box]	FIXED ROUTE 40'
[Orange Box]	FIXED ROUTE 60'
[Light Blue Box]	PARATRANSIT 25'
[Yellow Box]	VEHICLE MAINTENANCE
[Red Box]	OPERATIONS (GROUND)
[Grey Box]	OPERATIONS (ABOVE)
[Blue Box]	FUEL & WASH
[Light Blue Box]	FACILITY MAINTENANCE

DRAWING NUMBER <b>1(E)B</b>	DRAWING TITLE <b>OPTION 1(E)B NEW FACILITIES EAST W/ NEW OPS</b>	<p><b>PARSONS BRINCKERHOFF</b> 16200 PARK ROW SUITE 300 DENVER, CO, 80202 TEL: (303) 750-0900 FAX: (303) 750-0904</p>	PROJECT TITLE <b>ABQ RIDE YALE MAINTENANCE FACILITY ASSESSMENT</b>	PROJECT NO.	33722A
				DRAWN BY	MM
				DATE	4/17/2015
				SCALE	22x4 1/32" 11x17 1/64"

# CONCEPT DESIGN

---

## OPTION 1(E)C

### **New 40' Fixed Route Maintenance Facility (East) with New Operations above Maintenance**

This option constructs new 40' fixed route sized Maintenance, Fuel, and Wash facilities while demolishing the existing garages and Operations building. A new Operations space is constructed on the second level of the new Maintenance Facility. A new Facility Maintenance building is constructed adjacent to the new Yale Maintenance Facility.

Paratransit vehicles are added to the Yale Maintenance Facility's designed fleet responsibility and stored uncovered on the site with the new 40' fixed route bus parking layout.

#### DESIGN FLEET

60	FIXED ROUTE 40' BUSES
70	PARATRANSIT VEHICLES
130	TOTAL

20 NON-REVENUE VEHICLES

#### SITE ACCESS AND BUS FLOW

The site is configured for vehicles to enter via Yale Blvd, circulate the yard in an ideal counterclockwise drive pattern for nightly service, and exit the site via Yale Blvd. Secondary exits are provided on Buena Vista Drive and Bell Avenue. Isolated access for deliveries and paint/body vehicle circulation is provided via Yale Blvd.

#### MAINTENANCE

A new Maintenance Building with 6 repair bays for 40' vehicles, 6 repair bays for paratransit vehicles, and paint and body repair bays for 40' vehicles is constructed on the southeast corner of the site.

#### OPERATIONS

A new Operations Space is constructed on the second level of the Maintenance Building.

#### FACILITY MAINTENANCE

A new Facility Maintenance Building is constructed adjacent to the new Maintenance Building's south wall.

#### FUEL

A new Fuel Island with 3 lanes and associated support spaces is constructed in the northern portion of the yard. New CNG equipment is installed on the southern wall of the Wash Building.

#### WASH

A new Wash Building housing a 4-brush automatic wash system, chassis wash lane, and wash equipment spaces is constructed in line with the Fuel Island with adequate space to bypass wash.

#### BUS PARKING:

Fixed route 40' bus parking is located in the yard south of Fuel & Wash with paratransit parking directly above it. All vehicles are parked in 14' spaces which allow for wheelchair lifts to be operated in place during pullout. All paratransit vehicles can be accessed by moving a maximum of 1 vehicle.

#### EMPLOYEE / VISITOR PARKING

A total of 205 employee and visitor parking spaces are available. A new lot to the north of the Maintenance Building and fully separated from transit vehicles is constructed spanning the entire northern band of the site.



# CONCEPT DESIGN

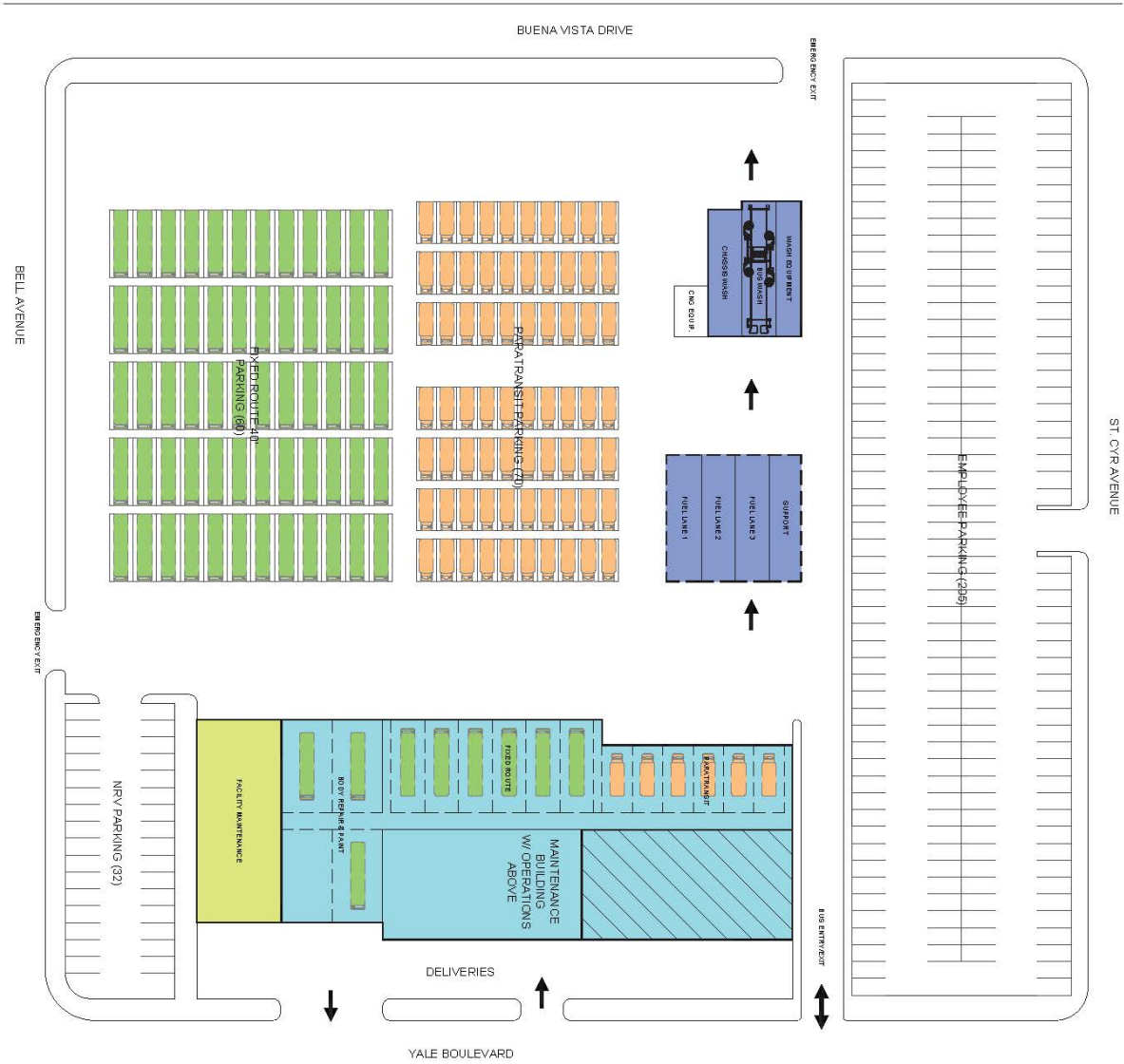

DESIGN FLEET	
60	FIXED ROUTE 40'
70	PARATRANSIT 25'
130	TOTAL
20 NRV	

LEGEND	
[Green Box]	FIXED ROUTE 40'
[Yellow Box]	FIXED ROUTE 60'
[Orange Box]	PARATRANSIT 25'
[Red Box]	VEHICLE MAINTENANCE OPERATIONS (GROUND)
[Blue Box]	OPERATIONS (ABOVE)
[Orange Box]	FUEL & WASH
[Green Box]	FACILITY MAINTENANCE

DRAWING NUMBER <b>1(E)C</b>	DRAWING TITLE <b>OPTION 1(E)C NEW FACILITIES EAST W/ OPS ABOVE MAINT</b>	 <small>16200 PARK ROW SUITE 300 DENVER, CO, 80202 TEL: (303) 750-0000 FAX: (303) 750-0000</small>	PROJECT TITLE <b>ABQ RIDE YALE MAINTENANCE FACILITY ASSESSMENT</b>	PROJECT NO.	33722A
				DRAWN BY	MM
				DATE	4/17/2015
				SCALE	22x34 1/32" 11x17 1/64"

# CONCEPT DESIGN

---

## OPTION 2(E)A

### **New 60' Fixed Route Maintenance Facility (East) with Existing Operations Building**

This option constructs new 60' fixed route sized Maintenance, Fuel, and Wash facilities while demolishing the existing garages and reusing the existing Operations buildings with a new Facility Maintenance building located near the demolished Sun Van building.

Paratransit vehicles are added to the Yale Maintenance Facility's designed fleet responsibility and stored uncovered on the site with the new 60' & 40' fixed route bus parking layout.

#### DESIGN FLEET

20	FIXED ROUTE 40' BUSES
30	FIXED ROUTE 60' BUSES
<u>70</u>	PARATRANSIT VEHICLES
120	TOTAL

20 NON-REVENUE VEHICLES

#### SITE ACCESS AND BUS FLOW

The site is configured for vehicles to enter via Bell Avenue, circulate the yard in an ideal counterclockwise drive pattern for nightly service, and exit the site via Bell Avenue. A secondary exit is provided on Buena Vista Drive. Isolated access for deliveries and paint/body vehicle circulation is provided via Yale Blvd.

#### MAINTENANCE

A new Maintenance Building with 6 repair bays for 60' vehicles, 6 repair bays for paratransit vehicles, and paint and body repair bays for 60' vehicles is constructed on the southeast corner of the site.

#### OPERATIONS

The existing Operations Building is reused. The building is renovated to bring it closer to the standards developed in the Design Criteria.

#### FACILITY MAINTENANCE

A new Facility Maintenance Building is located in the northeast quadrant of the site in the space previously occupied by the demolished Sun Van Building.

#### FUEL

A new Fuel Island with 3 lanes and associated support spaces is constructed on the southern boundary of the site. New CNG equipment is installed in the southwest corner of the site.

#### WASH

A new Wash Building housing a 4-brush automatic wash system, chassis wash lane, and wash equipment spaces is constructed in line with the Fuel Island with adequate space to bypass wash.

#### BUS PARKING:

Fixed route 40' bus parking is located in the north of the yard with 60' fixed route parking and paratransit parking directly below it. All vehicles are parked in 14' spaces which allow for wheelchair lifts to be operated in place during pullout. All fixed route vehicles can be accessed by moving a maximum of 1 vehicle.

#### EMPLOYEE / VISITOR PARKING

A total of 160 employee and visitor parking spaces are available. A new lot to the north of the Maintenance Building and fully separated from transit vehicles is constructed west of the Facility Maintenance Building. Adjustments in the existing parking near the demolished Sun Van Building are made to accommodate the new Facility Maintenance Building.

# CONCEPT DESIGN

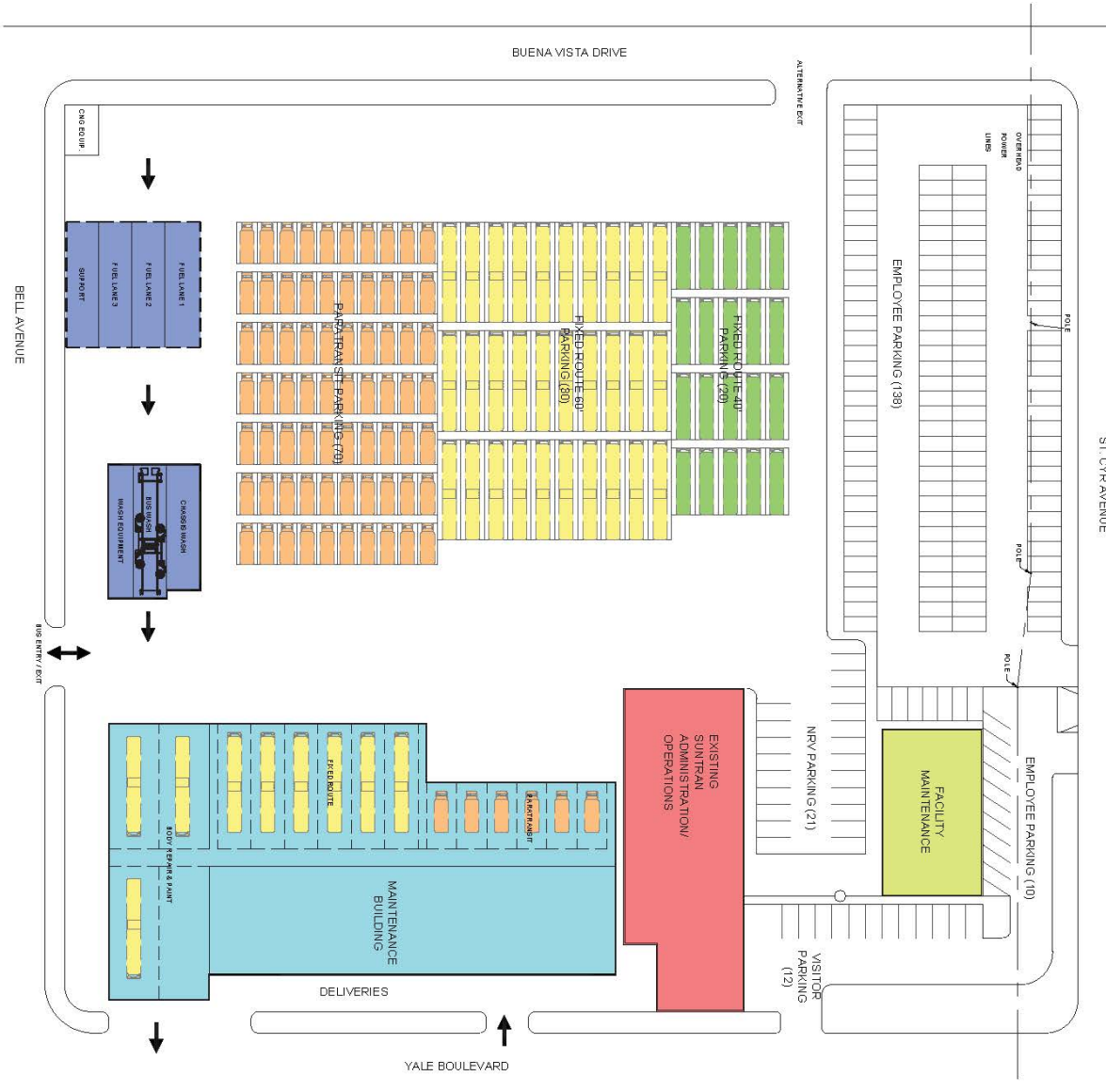

DESIGN FLEET	
20	FIXED ROUTE 40
30	FIXED ROUTE 60
70	PARATRANSIT 25
120	TOTAL
20	NRV

LEGEND	
[Green Box]	FIXED ROUTE 40
[Yellow Box]	FIXED ROUTE 60
[Orange Box]	PARATRANSIT 25
[Blue Box]	VEHICLE MAINTENANCE
[Light Blue Box]	OPERATIONS (GROUND)
[Dark Blue Box]	OPERATIONS (ABOVE)
[Light Green Box]	FUEL & WASH
[Light Yellow Box]	FACILITY MAINTENANCE

DRAWING NUMBER <b>2(E)A</b>	DRAWING TITLE <b>OPTION 2(E)A NEW FACILITIES EAST W/ EXISTING OPS</b>	<b>PARSONS BRINCKERHOFF</b> <small>16000 PARK ROW SUITE 500 HOUSTON, TEXAS 77056 TEL (281) 595-0900 FAX (281) 728-0064</small>	PROJECT TITLE <b>ABQ RIDE YALE MAINTENANCE FACILITY ASSESSMENT</b>	PROJECT NO. 33722A
				DRAWN BY MM
				DATE 4/17/2015
				SCALE 25x44 1/32" 11x17 1/64"

# CONCEPT DESIGN

---

## OPTION 2(E)B

### **New 60' Fixed Route Maintenance Facility (East) with New Operations Building**

This option constructs new 60' fixed route sized Maintenance, Fuel, and Wash facilities while demolishing the existing garages and Operations building. A new stand-alone Operations building is constructed near the demolished Sun Van building and a new Facility Maintenance building is constructed adjacent to the new Yale Maintenance Facility.

Paratransit vehicles are added to the Yale Maintenance Facility's designed fleet responsibility and stored uncovered on the site with the new 60' & 40' fixed route bus parking layout.

#### DESIGN FLEET

20	FIXED ROUTE 40' BUSES
30	FIXED ROUTE 60' BUSES
70	PARATRANSIT VEHICLES
120	TOTAL

20 NON-REVENUE VEHICLES

#### SITE ACCESS AND BUS FLOW

The site is configured for vehicles to enter via Yale Blvd, circulate the yard in an ideal counterclockwise drive pattern for nightly service, and exit the site via Yale Blvd. Secondary exits are provided on Buena Vista Drive and Bell Avenue. Isolated access for deliveries and paint/body vehicle circulation is provided via Yale Blvd.

#### MAINTENANCE

A new Maintenance Building with 6 repair bays for 60' vehicles, 6 repair bays for paratransit vehicles, and paint and body repair bays for 60' vehicles is constructed on the southeast corner of the site.

#### OPERATIONS

A new stand-alone Operations Building is constructed in place of the demolished Sun Van Building.

#### FACILITY MAINTENANCE

A new Facility Maintenance Building is constructed adjacent to the new Maintenance Building's north wall.

#### FUEL

A new Fuel Island with 3 lanes and associated support spaces is constructed in the northern portion of the yard. New CNG equipment is installed on the southern wall of the Wash Building.

#### WASH

A new Wash Building housing a 4-brush automatic wash system, chassis wash lane, and wash equipment spaces is constructed in line with the Fuel Island with adequate space to bypass wash.

#### BUS PARKING:

Paratransit parking is located in the yard south of Fuel & Wash with 60' fixed route parking and 40' fixed route parking directly below it. All vehicles are parked in 14' spaces which allow for wheelchair lifts to be operated in place during pullout. All fixed route vehicles can be accessed by moving a maximum of 1 vehicle.

#### EMPLOYEE / VISITOR PARKING

A total of 165 employee and visitor parking spaces are available. A new lot to the north of the Maintenance Building and fully separated from transit vehicles is constructed across the northern band of the site west of the new Operations Building.

# CONCEPT DESIGN

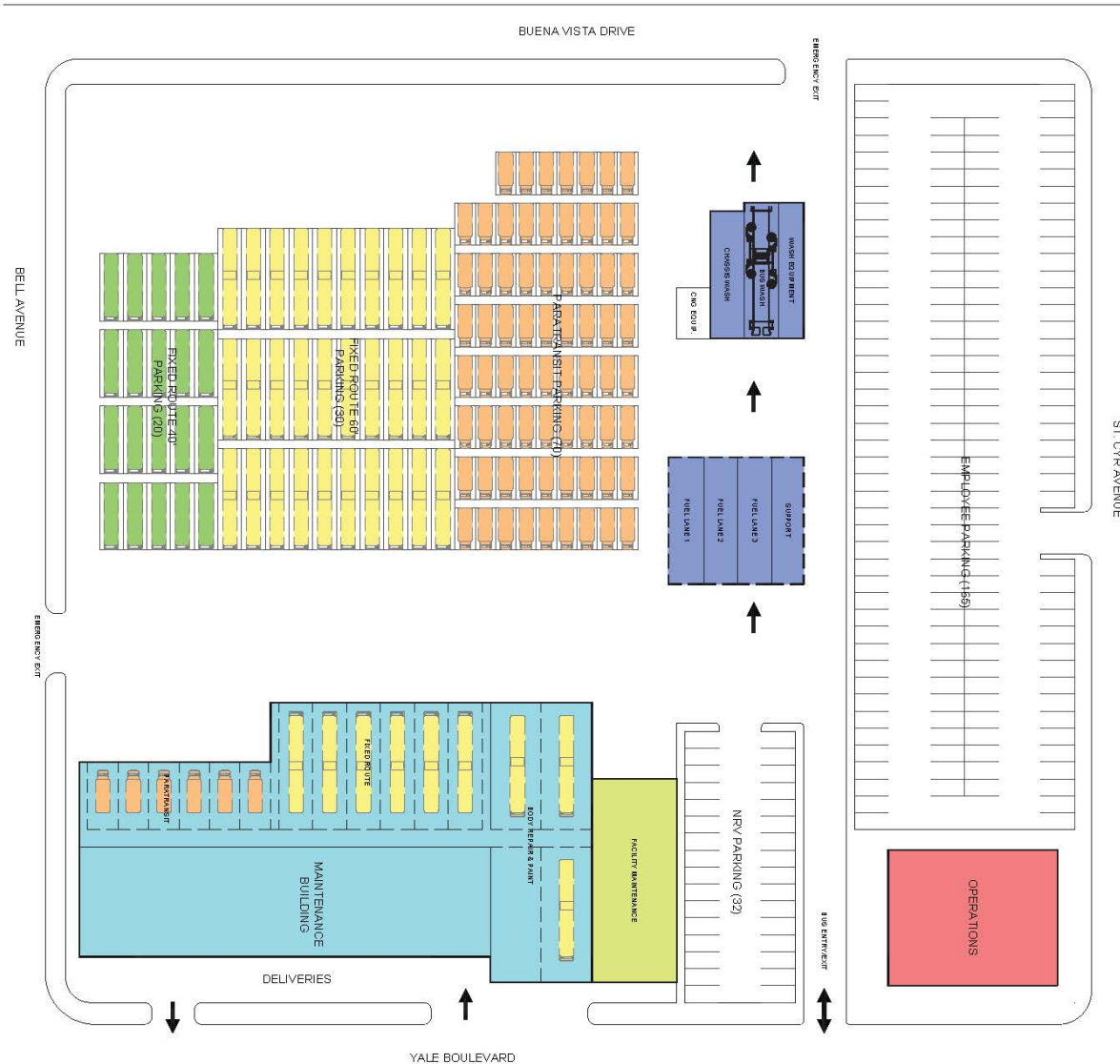

DESIGN FLEET	
20	FIXED ROUTE 40'
30	FIXED ROUTE 60'
70	PARATRANSIT 25'
120	TOTAL
20	NRV

LEGEND	
[Green Box]	FIXED ROUTE 40'
[Yellow Box]	FIXED ROUTE 60'
[Orange Box]	PARATRANSIT 25'
[Light Blue Box]	VEHICLE MAINTENANCE
[Red Box]	OPERATIONS (GROUND)
[Blue Box]	OPERATIONS (ABOVE)
[Orange Box]	FUEL & WASH
[Green Box]	FACILITY MAINTENANCE

DRAWING NUMBER <b>2(E)B</b>	DRAWING TITLE <b>OPTION 2(E)B NEW FACILITIES EAST W/ NEW OPS</b>	<b>PARSONS BRINCKERHOFF</b> <small>16000 PARK ROW SUITE 500 HOUSTON, TEXAS 77056 TEL (281) 596-0000 FAX (281) 738-0000</small>	PROJECT TITLE <b>ABQ RIDE YALE MAINTENANCE FACILITY ASSESSMENT</b>	PROJECT NO. 33722A DRAWN BY MM DATE 4/17/2015 SCALE 25x44 1/32" 11x17 1/64"
--------------------------------	---	---	---	---

# CONCEPT DESIGN

---

## OPTION 2(E)C

### **New 60' Fixed Route Maintenance Facility (East) with New Operations above Maintenance**

This option constructs new 60' fixed route sized Maintenance, Fuel, and Wash facilities while demolishing the existing garages and Operations building. A new Operations space is constructed on the second level of the new Maintenance Facility. A new Facility Maintenance building is constructed adjacent to the new Yale Maintenance Facility.

Paratransit vehicles are added to the Yale Maintenance Facility's designed fleet responsibility and stored uncovered on the site with the new 60' & 40' fixed route bus parking layout.

#### DESIGN FLEET

20	FIXED ROUTE 40' BUSES
30	FIXED ROUTE 60' BUSES
70	PARATRANSIT VEHICLES
120	TOTAL

20 NON-REVENUE VEHICLES

#### SITE ACCESS AND BUS FLOW

The site is configured for vehicles to enter via Yale Blvd, circulate the yard in an ideal counterclockwise drive pattern for nightly service, and exit the site via Yale Blvd. Secondary exits are provided on Buena Vista Drive and Bell Avenue. Isolated access for deliveries and paint/body vehicle circulation is provided via Yale Blvd.

#### MAINTENANCE

A new Maintenance Building with 6 repair bays for 60' vehicles, 6 repair bays for paratransit vehicles, and paint and body repair bays for 60' vehicles is constructed on the southeast corner of the site.

#### OPERATIONS

A new Operations Space is constructed on the second level of the Maintenance Building.

#### FACILITY MAINTENANCE

A new Facility Maintenance Building is constructed adjacent to the new Maintenance Building's south wall.

#### FUEL

A new Fuel Island with 3 lanes and associated support spaces is constructed in the northern portion of the yard. New CNG equipment is installed on the southern wall of the Wash Building.

#### WASH

A new Wash Building housing a 4-brush automatic wash system, chassis wash lane, and wash equipment spaces is constructed in line with the Fuel Island with adequate space to bypass wash.

#### BUS PARKING:

Paratransit parking is located in the yard south of Fuel & Wash with 60' fixed route parking and 40' fixed route parking directly below it. All vehicles are parked in 14' spaces which allow for wheelchair lifts to be operated in place during pullout. All fixed route vehicles can be accessed by moving a maximum of 1 vehicle.

#### EMPLOYEE / VISITOR PARKING

A total of 205 employee and visitor parking spaces are available. A new lot to the north of the Maintenance Building and fully separated from transit vehicles is constructed spanning the entire northern band of the site.

# CONCEPT DESIGN



DESIGN FLEET	
20	FIXED ROUTE 40*
30	FIXED ROUTE 60*
70	PARATRANSIT 25*
120	TOTAL
20	NRV

LEGEND	
[Green Box]	FIXED ROUTE 40*
[Yellow Box]	FIXED ROUTE 60*
[Orange Box]	PARATRANSIT 25*
[Blue Box]	VEHICLE MAINTENANCE
[Light Blue Box]	OPERATIONS (GROUND)
[Dark Blue Box]	OPERATIONS (ABOVE)
[Light Blue Box]	FUEL & WASH
[Light Blue Box]	FACILITY MAINTENANCE

DRAWING NUMBER <b>2(E)C</b>	DRAWING TITLE <b>OPTION 2(E)C NEW FACILITIES EAST W/ OPS ABOVE MAINT</b>	<b>PARSONS BRINCKERHOFF</b> <small>16000 PARK ROW SUITE 500 HOUSTON, TEXAS 77056 TEL (281) 596-0900 FAX (281) 758-0064</small>	PROJECT TITLE <b>ABQ RIDE YALE MAINTENANCE FACILITY ASSESSMENT</b>	PROJECT NO. 33722A DRAWN BY MM DATE 4/17/2015 SCALE 22x34 1/32" 11x17 1/64"
--------------------------------	---	---	---	---

# CONCEPT DESIGN

---

## OPTION 2(N)A

### **New 60' Fixed Route Maintenance Facility (North) with Existing Operations Building**

This option constructs new 60' fixed route sized Maintenance, Fuel, and Wash facilities while demolishing the existing garages and reusing the existing Operations buildings with a new Facility Maintenance building adjacent to the new Maintenance Facility located at the north of the site.

Paratransit vehicles are added to the Yale Maintenance Facility's designed fleet responsibility and stored uncovered on the site with the new 60' & 40' fixed route bus parking layout.

#### DESIGN FLEET

20	FIXED ROUTE 40' BUSES
30	FIXED ROUTE 60' BUSES
<u>70</u>	PARATRANSIT VEHICLES
120	TOTAL

20 NON-REVENUE VEHICLES

#### SITE ACCESS AND BUS FLOW

The site is configured for vehicles to enter via Bell Avenue, circulate the yard in an ideal counterclockwise drive pattern for nightly service, and exit the site via Bell Avenue. A secondary exit is provided on Buena Vista Drive. Paint/body vehicle circulation is provided via St. Cyr Avenue. Deliveries must pass through transit vehicle circulation.

#### MAINTENANCE

A new Maintenance Building with 6 repair bays for 60' vehicles, 6 repair bays for paratransit vehicles, and paint and body repair bays for 60' vehicles is constructed on the north of the site.

#### OPERATIONS

The existing Operations Building is reused. The building is renovated to bring it closer to the standards developed in the Design Criteria.

#### FACILITY MAINTENANCE

A new Facility Maintenance Building is constructed adjacent to the new Maintenance Building's east wall.

#### FUEL

A new Fuel Island with 3 lanes and associated support spaces is constructed on the eastern boundary of the yard. New CNG equipment is installed on the southeast corner of the Fuel Island. Vehicles cannot bypass the adjacent Wash Building.

#### WASH

A new Wash Building housing two 4-brush automatic wash systems, chassis wash lane, and wash equipment spaces is constructed in line and adjacent to the Fuel Island due to space restraints. This requires the purchase of an additional bus washer since there is insufficient space for vehicles to queue into a single wash lane.

#### BUS PARKING:

Fixed route 40' bus parking is located south of the Maintenance Facility with 60' fixed route parking adjacent and paratransit parking below. All vehicles are parked in 14' spaces which allow for wheelchair lifts to be operated in place during pullout. All vehicles can be accessed by moving a maximum of 1 vehicle.

#### EMPLOYEE / VISITOR PARKING

A total of 158 employee and visitor parking spaces are available. A new lot, which is fully separated from transit circulation, is constructed on the east of the site and split by the existing Operations Building.



# CONCEPT DESIGN

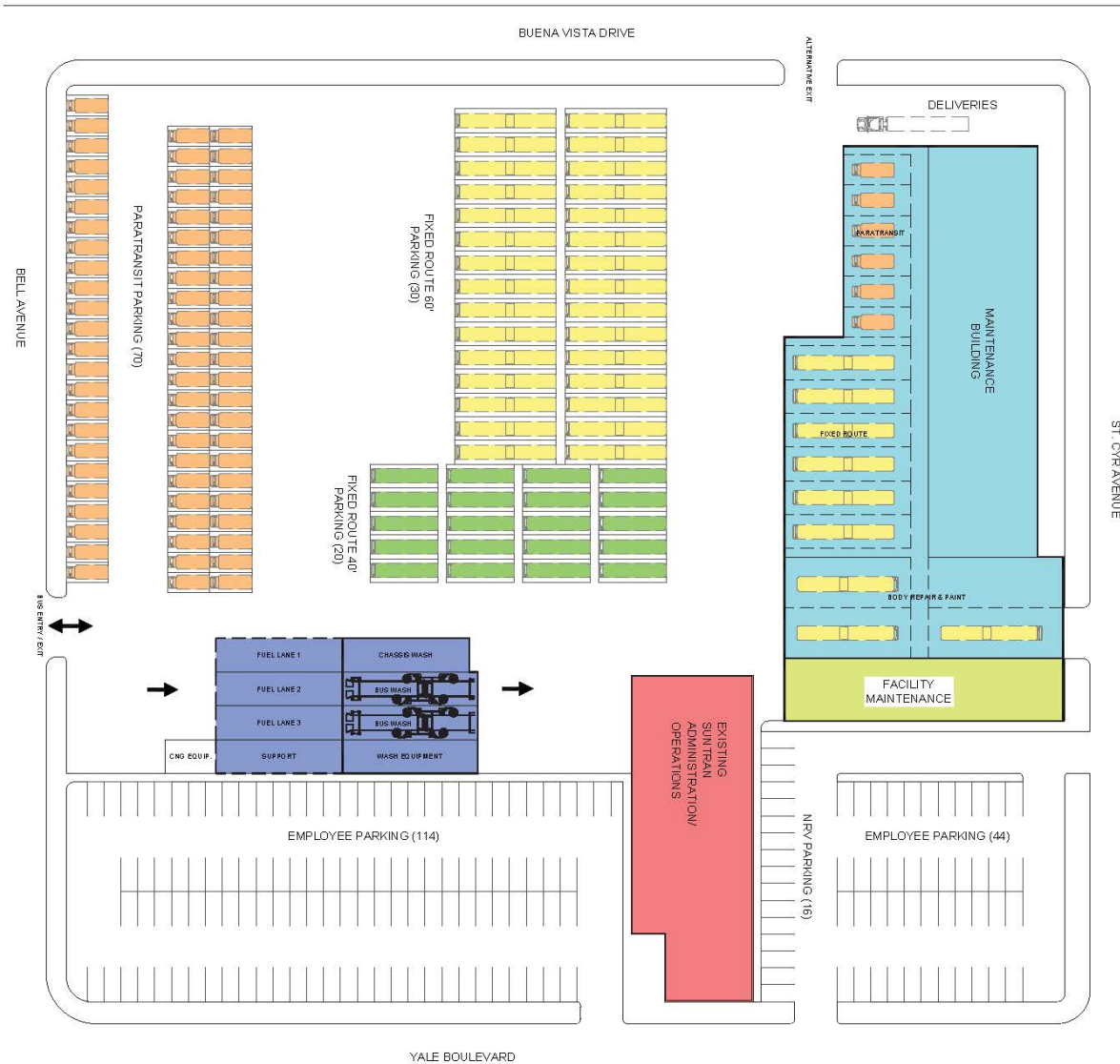

DESIGN FLEET	
20	FIXED ROUTE 40
30	FIXED ROUTE 60
70	PARATRANSIT 25'
120	TOTAL
20	NRV

LEGEND	
[Green Box]	FIXED ROUTE 40
[Yellow Box]	FIXED ROUTE 60
[Orange Box]	PARATRANSIT 25'
[Blue Box]	VEHICLE MAINTENANCE
[Light Blue Box]	OPERATIONS (GROUND)
[Light Green Box]	OPERATIONS (ABOVE)
[Dark Blue Box]	FUEL & WASH
[Red Box]	FACILITY MAINTENANCE

DRAWING NUMBER <b>2(N)A</b>	DRAWING TITLE <b>OPTION 2(N)A NEW FACILITIES NORTH W/ EXISTING OPS</b>	<b>PARSONS BRINCKERHOFF</b> <small>16000 PARK ROW SUITE 500 HOUSTON, TEXAS 77056 TEL (281) 596-6900 FAX (281) 728-8066</small>	PROJECT TITLE <b>ABQ RIDE YALE MAINTENANCE FACILITY ASSESSMENT</b>	PROJECT NO. 33722A DRAWN BY MM DATE 4/17/2015 SCALE 22x34 1/32" 11x17 1/64"
--------------------------------	---	---	---	---

# CONCEPT DESIGN

---

## OPTION 2(N)B

### **New 60' Fixed Route Maintenance Facility (North) with New Operations Building**

This option constructs new 60' fixed route sized Maintenance, Fuel, and Wash facilities while demolishing the existing garages and Operations building. A new stand-alone Operations building is constructed on the eastern portion of the site and a new Facility Maintenance building is constructed adjacent to the new Yale Maintenance Facility on the north of the site.

Paratransit vehicles are added to the Yale Maintenance Facility's designed fleet responsibility and stored uncovered on the site with the new 60' & 40' fixed route bus parking layout.

#### DESIGN FLEET

20	FIXED ROUTE 40' BUSES
30	FIXED ROUTE 60' BUSES
70	PARATRANSIT VEHICLES
120	TOTAL

20 NON-REVENUE VEHICLES

#### SITE ACCESS AND BUS FLOW

The site is configured for vehicles to enter via Yale Avenue, circulate the yard in an ideal counterclockwise drive pattern for nightly service, and exit the site via Bell Avenue. Secondary exits are provided on Buena Vista Drive and Yale Blvd. Paint/body vehicle circulation is provided via St. Cyr Avenue. Deliveries must pass through transit vehicle circulation.

#### MAINTENANCE

A new Maintenance Building with 6 repair bays for 60' vehicles, 6 repair bays for paratransit vehicles, and paint and body repair bays for 60' vehicles is constructed on the north corner of the site.

#### OPERATIONS

A new stand-alone Operations Building is constructed in place of the demolished existing Operations Building.

#### FACILITY MAINTENANCE

A new Facility Maintenance Building is constructed adjacent to the new Maintenance Building's north wall.

#### FUEL

A new Fuel Island with 3 lanes and associated support spaces is constructed in the southeast portion of the yard next to the new employee parking. New CNG equipment is installed south of the Fuel Island.

#### WASH

A new Wash Building housing a 4-brush automatic wash system, chassis wash lane, and wash equipment spaces is constructed in line with the Fuel Island with adequate space to bypass wash.

#### BUS PARKING:

Paratransit parking is located in the yard east of Fuel & Wash with 60' fixed route parking and 40' fixed route parking directly north of it. All vehicles are parked in 14' spaces which allow for wheelchair lifts to be operated in place during pullout. All vehicles can be accessed by moving a maximum of 1 vehicle.

#### EMPLOYEE / VISITOR PARKING

A total of 145 employee and visitor parking spaces are available. New lots to the south and north of the new Operations Building and fully separated from transit vehicles are constructed across the eastern band of the site.

# CONCEPT DESIGN

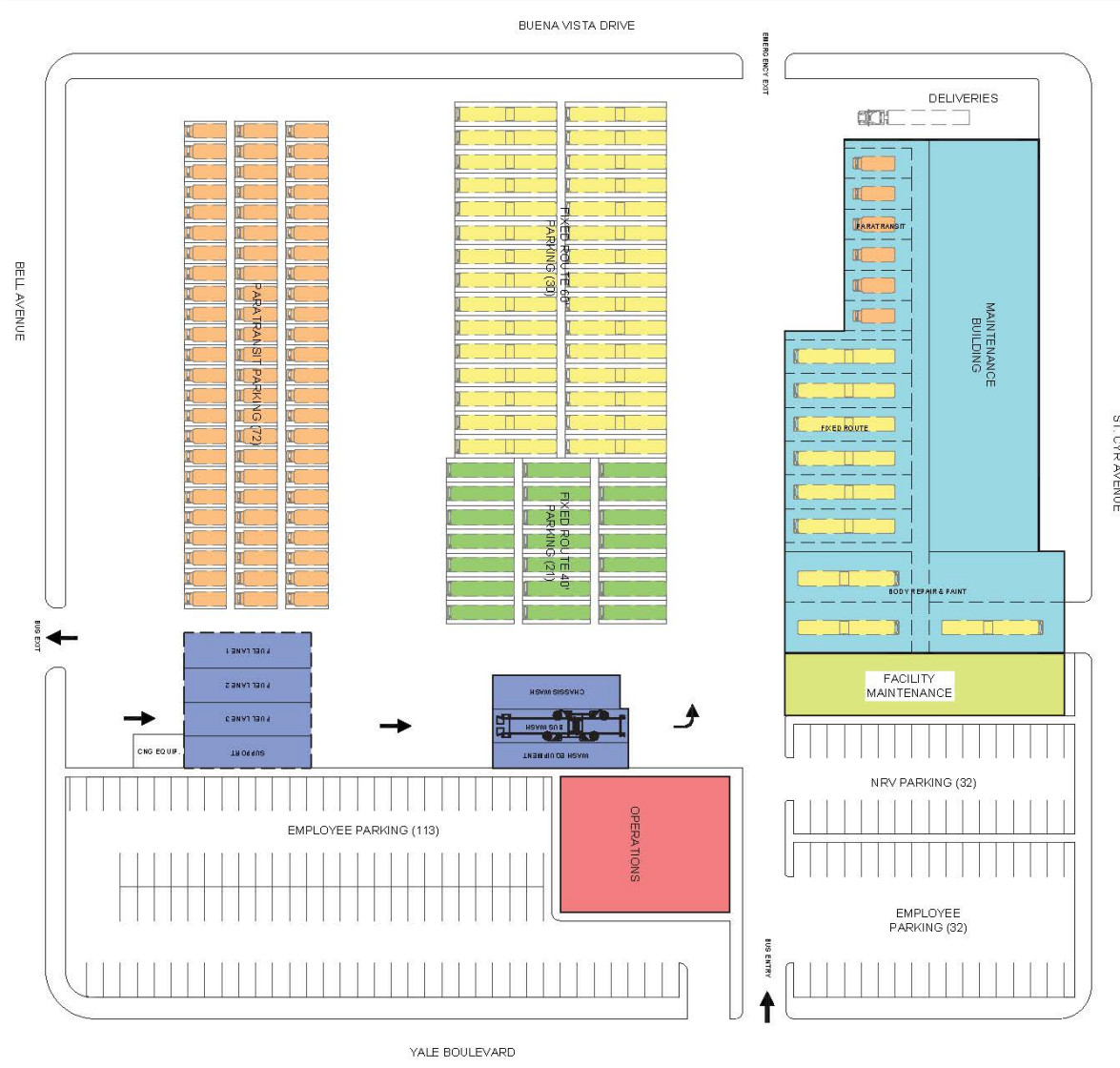

DESIGN FLEET	
20	FIXED ROUTE 40*
30	FIXED ROUTE 60*
70	PARATRANSIT 25*
120	TOTAL
20	NRV

LEGEND	
[Green]	FIXED ROUTE 40*
[Yellow]	FIXED ROUTE 60*
[Orange]	PARATRANSIT 25*
[Light Blue]	VEHICLE MAINTENANCE
[Red]	OPERATIONS (GROUND)
[Dark Blue]	OPERATIONS (ABOVE)
[Blue]	FUEL & WASH
[Light Green]	FACILITY MAINTENANCE

DRAWING NUMBER <b>2(N)B</b>	DRAWING TITLE <b>OPTION 2(N)B NEW FACILITIES NORTH W/ NEW OPS</b>	<b>PARSONS BRINCKERHOFF</b> <small>16000 PARK ROW SUITE 500 HOUSTON, TEXAS 77056 TEL: (281) 596-0900 FAX: (281) 728-0044</small>	PROJECT TITLE <b>ABQ RIDE YALE MAINTENANCE FACILITY ASSESSMENT</b>	PROJECT NO. 33722A
				DRAWN BY MM
				DATE 4/17/2015
				SCALE 22x44 1/32" 11x17 1/64"

# CONCEPT DESIGN

---

## OPTION 2(N)C

### **New 60' Fixed Route Maintenance Facility (North) with New Operations above Maintenance**

This option constructs new 60' fixed route sized Maintenance, Fuel, and Wash facilities while demolishing the existing garages and Operations building. . . A new Operations space is constructed on the second level of the new Maintenance Facility. A new Facility Maintenance building is constructed adjacent to the new Yale Maintenance Facility on the north of the site.

Paratransit vehicles are added to the Yale Maintenance Facility's designed fleet responsibility and stored uncovered on the site with the new 60' & 40' fixed route bus parking layout.

#### DESIGN FLEET

20	FIXED ROUTE 40' BUSES
30	FIXED ROUTE 60' BUSES
70	PARATRANSIT VEHICLES
120	TOTAL

20 NON-REVENUE VEHICLES

#### SITE ACCESS AND BUS FLOW

The site is configured for vehicles to enter via Yale Blvd, circulate the yard in an ideal counterclockwise drive pattern for nightly service, and exit the site via Bell Avenue. Secondary exits are provided on Buena Vista Drive and Yale Blvd. Isolated access for deliveries is provided by Buena Vista Drive.

#### MAINTENANCE

A new Maintenance Building with 6 repair bays for 60' vehicles, 6 repair bays for paratransit vehicles, and paint and body repair bays for 60' vehicles is constructed south of the new employee parking lot. Pull-through access for Paint and Body is not available in this configuration.

#### OPERATIONS

A new Operations Space is constructed on the second level of the Maintenance Building.

#### FACILITY MAINTENANCE

A new Facility Maintenance Building is constructed adjacent to the new Maintenance Building's east wall.

#### FUEL

A new Fuel Island with 3 lanes and associated support spaces is constructed on the southeast portion of the yard. New CNG equipment is installed south of the Fuel Island. Vehicles cannot bypass the adjacent Wash Building.

#### WASH

A new Wash Building housing two 4-brush automatic wash systems, chassis wash lane, and wash equipment spaces is constructed in line and adjacent to the Fuel Island due to space restraints. This requires the purchase of an additional bus washer since there is insufficient space for vehicles to queue into a single wash lane.

#### BUS PARKING:

60' fixed route bus, 40' fixed route, and paratransit parking is located in line in the yard south of the new Maintenance Facility. Additional paratransit parking is also located east of the Maintenance Building. All vehicles are parked in 14' spaces which allow for wheelchair lifts to be operated in place during pullout. All fixed route vehicles can be accessed by moving a maximum of 1 vehicle.

#### EMPLOYEE / VISITOR PARKING

A total of 205 employee and visitor parking spaces are available. A new lot to the north of the Maintenance Building and fully separated from transit vehicles is constructed spanning the entire northern band of the site.

# CONCEPT DESIGN

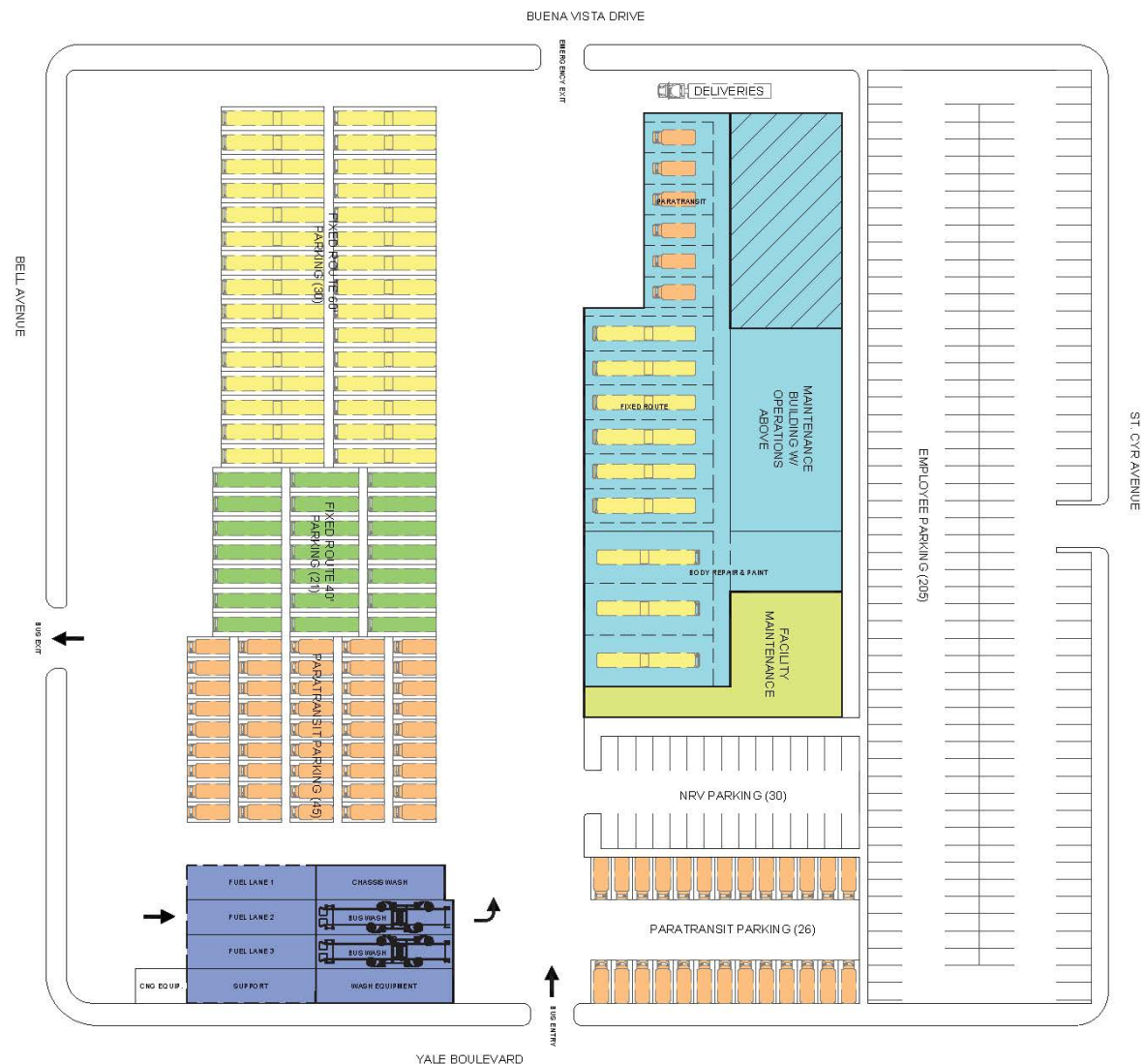

DESIGN FLEET	
20	FIXED ROUTE 40'
30	FIXED ROUTE 60'
70	PARATRANSIT 25'
120	TOTAL
20	NRV

LEGEND	
[Green Box]	FIXED ROUTE 40'
[Yellow Box]	FIXED ROUTE 60'
[Orange Box]	PARATRANSIT 25'
[Blue Box]	VEHICLE MAINTENANCE
[Light Blue Box]	OPERATIONS (GROUND)
[Light Green Box]	OPERATIONS (ABOVE)
[Light Blue Box]	FUEL & WASH
[Light Green Box]	FACILITY MAINTENANCE

DRAWING NUMBER <b>2(N)C</b>	DRAWING TITLE <b>OPTION 2(N)C NEW FACILITIES NORTH W/ OPS ABOVE MAINT</b>	 <small>16000 PARK ROW SUITE 300 NEWPORT, TEXAS 77459 TEL: (281) 808-0800 FAX: (281) 728-0164</small>	PROJECT TITLE <b>ABQ RIDE YALE MAINTENANCE FACILITY ASSESSMENT</b>	PROJECT NO.	33722A
				DRAWN BY	MM
				DATE	4/17/2015
				SCALE	22x4 1/32" 11x17 1/64"

# CONCEPT DESIGN

---

## OPTION 3(X)

### **Reuse Existing Facilities for Paratransit**

This option reuses the existing Maintenance, Fuel, Wash, Garages, and Operations buildings with a new Facility Maintenance building located near the demolished Sun Van building. The layout of the facility and site is similar to Option 1, but all bays are set up to serve paratransit vehicles only.

Paratransit vehicles are added to the Yale Maintenance Facility's designed fleet responsibility and stored in the existing "Old" Garage and within newly striped yard parking

#### DESIGN FLEET

140 PARATRANSIT VEHICLES

140 TOTAL

20 NON-REVENUE VEHICLES

#### SITE ACCESS AND BUS FLOW

Vehicles continue to enter the site from Bell Avenue with and circulate in a clockwise manner, which poses higher operational risks. Vehicles exit from the garages onto Yale Blvd. Circulation space is very limited with multiple staging areas occurring in or near drive lanes. Delivery vehicles must enter transit circulation for drop-offs.

#### MAINTENANCE

The existing Maintenance Building is reused. New maintenance and storage equipment is installed and the facility is renovated to bring it closer to the standards developed in the Design Criteria. Fixed route 40' vehicles are unable to be accommodated without additional equipment and fixed route 60' buses are never able to be accommodated.

#### OPERATIONS

The existing Operations Building is reused. The building is renovated to bring it closer to the standards developed in the Design Criteria.

#### FACILITY MAINTENANCE

A new Facility Maintenance Building is located in the northeast quadrant of the site in the space previously occupied by the demolished Sun Van Building.

#### FUEL

The existing Fuel Island is reused. New fueling and service equipment is installed and the buildings and canopy are renovated to bring them closer to the standards developed in the Design Criteria. Fixed Route 60' buses are unable to be accommodated.

#### WASH

The existing Wash Building is reused. A new bus washer and chassis wash equipment are installed and the building is renovated to bring it closer to the standards developed in the Design Criteria. Fixed Route 60' buses are unable to be accommodated.

#### BUS PARKING:

All of ABQ Ride's Paratransit vehicles are housed on the site and parked in the "Old" Garage Building, "New" Garage Building, and Paratransit parking in the yard south of the Maintenance Building.

#### EMPLOYEE / VISITOR PARKING

A total of 136 employee and visitor parking spaces are available. The existing lot to the north of the Maintenance Building separated by a fence and gate remains in place. Adjustments to the parking area near the demolished Sun Van Building are made to accommodate the new Facility Maintenance Building.

# CONCEPT DESIGN

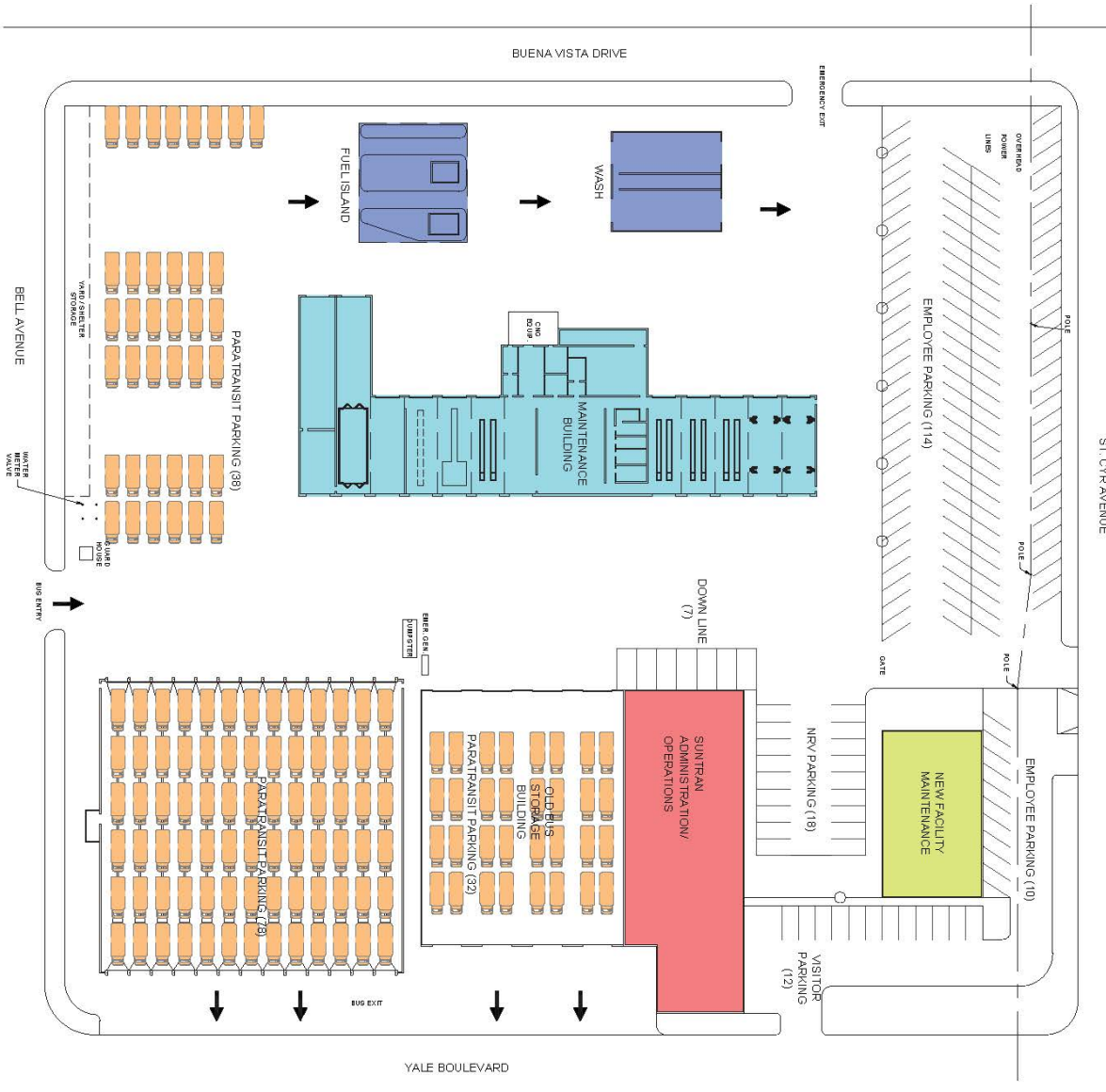

**DESIGN FLEET**

140	PARATRANSIT 25'
140	TOTAL
20	NRV

**LEGEND**

- FIXED ROUTE 40'
- FIXED ROUTE 60'
- PARATRANSIT 25'
- VEHICLE MAINTENANCE OPERATIONS (GROUND)
- OPERATIONS (ABOVE)
- FUEL & WASH
- FACILITY MAINTENANCE

DRAWING NUMBER  3(X)	DRAWING TITLE OPTION 3 EXISTING FACILITIES	<p><b>PARSONS BRINCKERHOFF</b></p> <p>16200 PARK ROW SUITE 300 NEWPORT, TEXAS 77464 TEL: (281) 808-0800 FAX: (281) 728-0964</p>	PROJECT TITLE ABQ RIDE YALE MAINTENANCE FACILITY ASSESSMENT	PROJECT NO.	33722A
				DRAWN BY	MM
				SCALE	22x94 1/32" 11x17 1/64"

# CONCEPT DESIGN

---

## OPTION 3(E)A

### **New Paratransit Maintenance Facility (East) with Existing Operations Building**

This option constructs new paratransit designed Maintenance, Fuel, and Wash facilities while demolishing the existing garages and reusing the existing Operations buildings with a new Facility Maintenance building located near the demolished Sun Van building. The layout of the facility and site is similar to Option 1, but all bays are set up to serve paratransit vehicles only.

Paratransit vehicles are added to the Yale Maintenance Facility's designed fleet responsibility and stored uncovered on the site.

#### DESIGN FLEET

140 PARATRANSIT VEHICLES  
140 TOTAL

20 NON-REVENUE VEHICLES

#### SITE ACCESS AND BUS FLOW

The site is configured for vehicles to enter via Bell Avenue, circulate the yard in an ideal counterclockwise drive pattern for nightly service, and exit the site via Bell Avenue. A secondary exit is provided on Buena Vista Drive. Isolated access for deliveries and paint/body vehicle circulation is provided via Yale Blvd.

#### MAINTENANCE

A new Maintenance Building with 12 repair bays for paratransit vehicles, and paint and body repair bays for paratransit vehicles is constructed on the southeast corner of the site.

#### OPERATIONS

The existing Operations Building is reused. The building is renovated to bring it closer to the standards developed in the Design Criteria.

#### FACILITY MAINTENANCE

A new Facility Maintenance Building is located in the northeast quadrant of the site in the space previously occupied by the demolished Sun Van Building.

#### FUEL

A new Fuel Island with 3 lanes and associated support spaces is constructed on the southern boundary of the site. New CNG equipment is installed in the southwest corner of the site.

#### WASH

A new Wash Building housing a 4-brush automatic wash system, chassis wash lane, and wash equipment spaces is constructed in line with the Fuel Island with adequate space to bypass wash.

#### BUS PARKING:

Paratransit parking is located in the north of the yard. All vehicles are parked in 14' spaces which allow for wheelchair lifts to be operated in place during pullout. Immediate access to each vehicle is available.

#### EMPLOYEE / VISITOR PARKING

A total of 160 employee and visitor parking spaces are available. A new lot to the north of the Maintenance Building and fully separated from transit vehicles is constructed west of the Facility Maintenance Building. Adjustments in the existing parking near the demolished Sun Van Building are made to accommodate the new Facility Maintenance Building.



# CONCEPT DESIGN

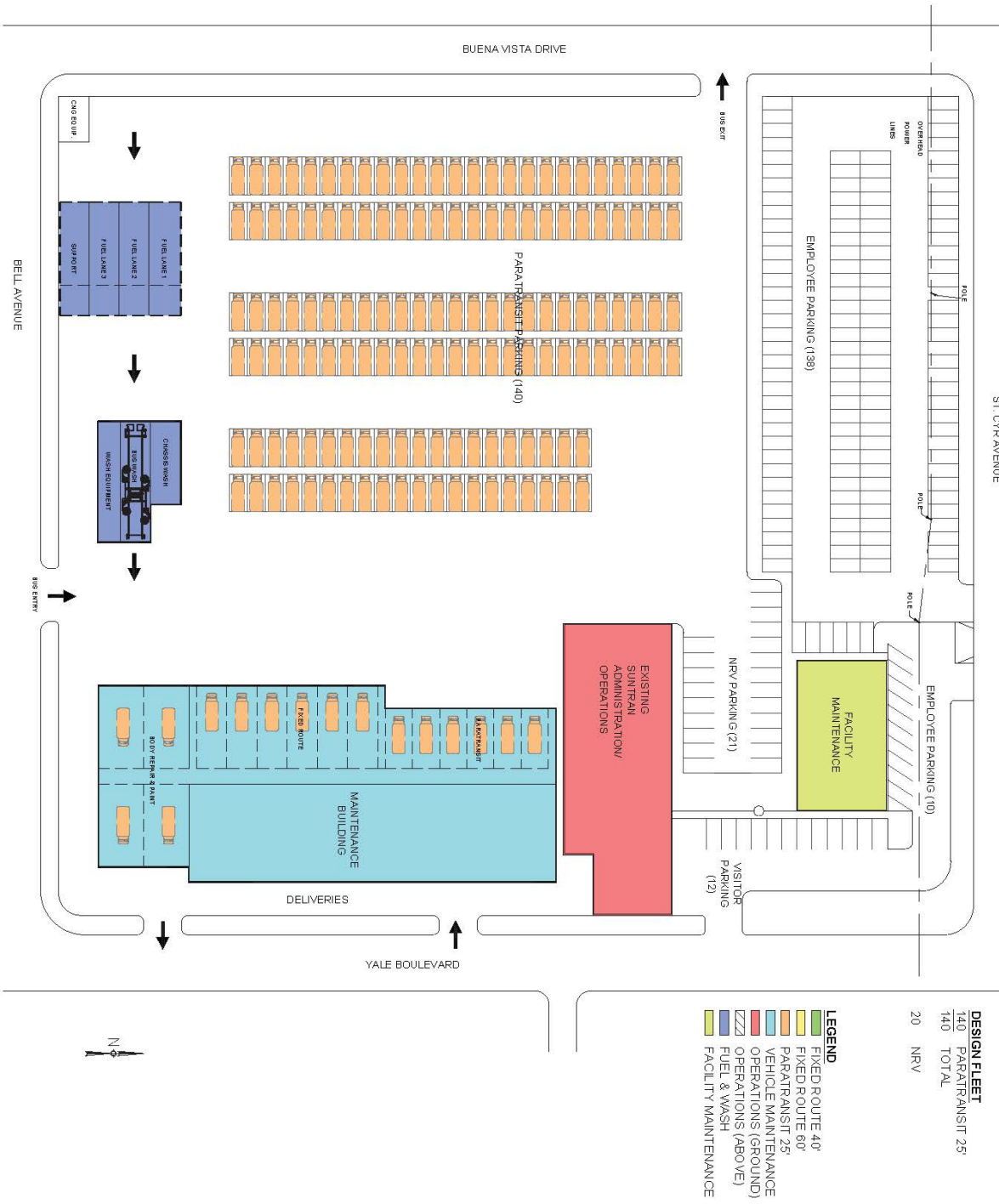

**DESIGN FLEET**

140	PARATRANSIT 25'
140	TOTAL
20	NRV

- LEGEND**
- █ FIXED ROUTE 40'
  - █ FIXED ROUTE 60'
  - █ PARATRANSIT 25'
  - █ VEHICLE MAINTENANCE
  - █ OPERATIONS (GROUND)
  - █ OPERATIONS (ABOVE)
  - █ FUEL & WASH
  - █ FACILITY MAINTENANCE

DRAWING NUMBER <b>3(E)A</b>	DRAWING TITLE <b>OPTION 3(E)A NEW FACILITIES EAST W/ EXISTING OPS</b>	 <small>16000 PARK ROW SUITE 500 HOUSTON, TEXAS 77056 TEL (281) 595-0900 FAX (281) 738-0066</small>	PROJECT TITLE <b>ABQ RIDE YALE MAINTENANCE FACILITY ASSESSMENT</b>	PROJECT NO.	33722A
				DRAWN BY	MM
				DATE	4/17/2015
				SCALE	22x44 1/32" 11x17 1/64"

# CONCEPT DESIGN

---

## OPTION 3(E)B

### **New Paratransit Maintenance Facility (East) with New Operations Building**

This option constructs new paratransit designed Maintenance, Fuel, and Wash facilities while demolishing the existing garages and Operations building. A new stand-alone Operations building is constructed near the demolished Sun Van building and a new Facility Maintenance building is constructed adjacent to the new Yale Maintenance Facility. The layout of the facility and site is similar to Option 1, but all bays are set up to serve paratransit vehicles only.

Paratransit vehicles are added to the Yale Maintenance Facility's designed fleet responsibility and stored uncovered on the site.

#### DESIGN FLEET

140 PARATRANSIT VEHICLES

140 TOTAL

20 NON-REVENUE VEHICLES

#### SITE ACCESS AND BUS FLOW

The site is configured for vehicles to enter via Yale Blvd, circulate the yard in an ideal counterclockwise drive pattern for nightly service, and exit the site via Yale Blvd. Secondary exits are provided on Buena Vista Drive and Bell Avenue. Isolated access for deliveries and paint/body vehicle circulation is provided via Yale Blvd.

#### MAINTENANCE

A new Maintenance Building with 12 repair bays for paratransit vehicles, and paint and body repair bays for paratransit vehicles is constructed on the southeast corner of the site.

#### OPERATIONS

A new stand-alone Operations Building is constructed in place of the demolished Sun Van Building.

#### FACILITY MAINTENANCE

A new Facility Maintenance Building is constructed adjacent to the new Maintenance Building's north wall.

#### FUEL

A new Fuel Island with 3 lanes and associated support spaces is constructed in the northern portion of the yard. New CNG equipment is installed on the southern wall of the Wash Building.

#### WASH

A new Wash Building housing a 4-brush automatic wash system, chassis wash lane, and wash equipment spaces is constructed in line with the Fuel Island with adequate space to bypass wash.

#### BUS PARKING:

Paratransit parking is located in the north of the yard. All vehicles are parked in 14' spaces which allow for wheelchair lifts to be operated in place during pullout. Immediate access to each vehicle is available.

#### EMPLOYEE / VISITOR PARKING

A total of 165 employee and visitor parking spaces are available. A new lot to the north of the Maintenance Building and fully separated from transit vehicles is constructed across the northern band of the site west of the new Operations Building.

# CONCEPT DESIGN

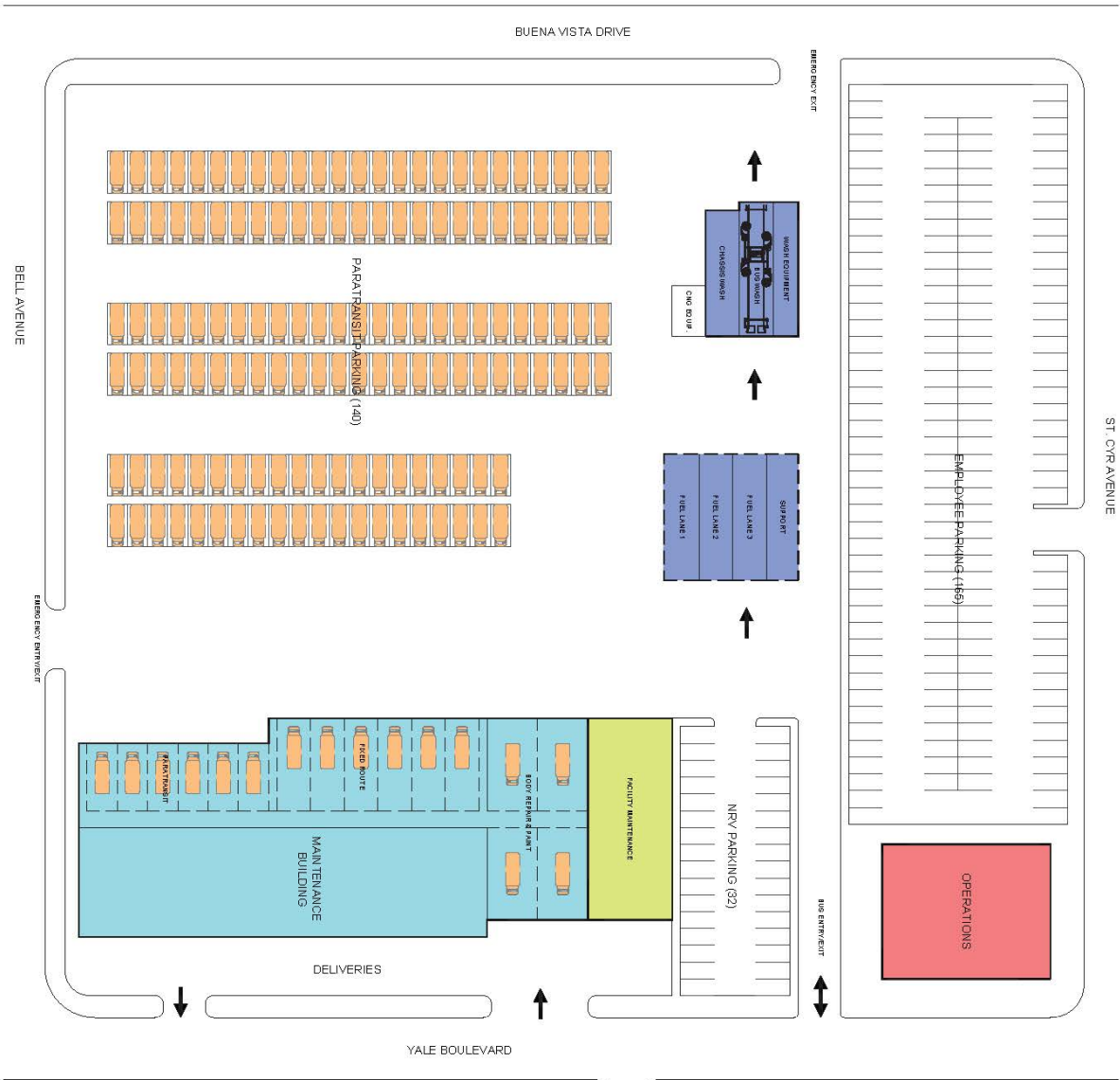

DESIGN FLEET	
140	PARATRANSIT 25
140	TOTAL
20	NRV

LEGEND	
[Green]	FIXED ROUTE 40
[Yellow]	FIXED ROUTE 60
[Orange]	PARATRANSIT 25
[Light Blue]	VEHICLE MAINTENANCE
[Dark Blue]	OPERATIONS (GROUND)
[Red]	OPERATIONS (ABOVE)
[Blue]	FUEL & WASH
[Light Green]	FACILITY MAINTENANCE

DRAWING NUMBER <b>3(E)B</b>	DRAWING TITLE <b>OPTION 3(E)B NEW FACILITIES EAST W/ NEW OPS</b>	 <small>16000 PARK ROW SUITE 500 HOUSTON, TEXAS 77056 TEL (281) 595-0900 FAX (281) 728-9066</small>	PROJECT TITLE <b>ABQ RIDE YALE MAINTENANCE FACILITY ASSESSMENT</b>	PROJECT NO. 33722A DRAWN BY MM DATE 4/17/2015 SCALE 25x44 1/32" 11x17 1/64"
--------------------------------	---	--	---	---

# CONCEPT DESIGN

---

## OPTION 3(E)C

### **New Paratransit Maintenance Facility (East) with New Operations Above Maintenance**

This option constructs new 40' fixed route sized Maintenance, Fuel, and Wash facilities while demolishing the existing garages and Operations building. A new Operations space is constructed on the second level of the new Maintenance Facility. A new Facility Maintenance building is constructed adjacent to the new Yale Maintenance Facility. The layout of the facility and site is similar to Option 1, but all bays are set up to serve paratransit vehicles only.

Paratransit vehicles are added to the Yale Maintenance Facility's designed fleet responsibility and stored uncovered on the site.

#### DESIGN FLEET

140 PARATRANSIT VEHICLES

140 TOTAL

20 NON-REVENUE VEHICLES

#### SITE ACCESS AND BUS FLOW

The site is configured for vehicles to enter via Yale Blvd, circulate the yard in an ideal counterclockwise drive pattern for nightly service, and exit the site via Yale Blvd. Secondary exits are provided on Buena Vista Drive and Bell Avenue. Isolated access for deliveries and paint/body vehicle circulation is provided via Yale Blvd.

#### MAINTENANCE

A new Maintenance Building with 12 repair bays for paratransit vehicles, and paint and body repair bays for paratransit vehicles is constructed on the southeast corner of the site.

#### OPERATIONS

A new Operations Space is constructed on the second level of the Maintenance Building.

#### FACILITY MAINTENANCE

A new Facility Maintenance Building is constructed adjacent to the new Maintenance Building's south wall.

#### FUEL

A new Fuel Island with 3 lanes and associated support spaces is constructed in the northern portion of the yard. New CNG equipment is installed on the southern wall of the Wash Building.

#### WASH

A new Wash Building housing a 4-brush automatic wash system, chassis wash lane, and wash equipment spaces is constructed in line with the Fuel Island with adequate space to bypass wash.

#### BUS PARKING:

Paratransit parking is located in the yard south of Fuel and Wash. All vehicles are parked in 14' spaces which allow for wheelchair lifts to be operated in place during pullout. Immediate access to each vehicle is available.

#### EMPLOYEE / VISITOR PARKING

A total of 205 employee and visitor parking spaces are available. A new lot to the north of the Maintenance Building and fully separated from transit vehicles is constructed spanning the entire northern band of the site.

# CONCEPT DESIGN

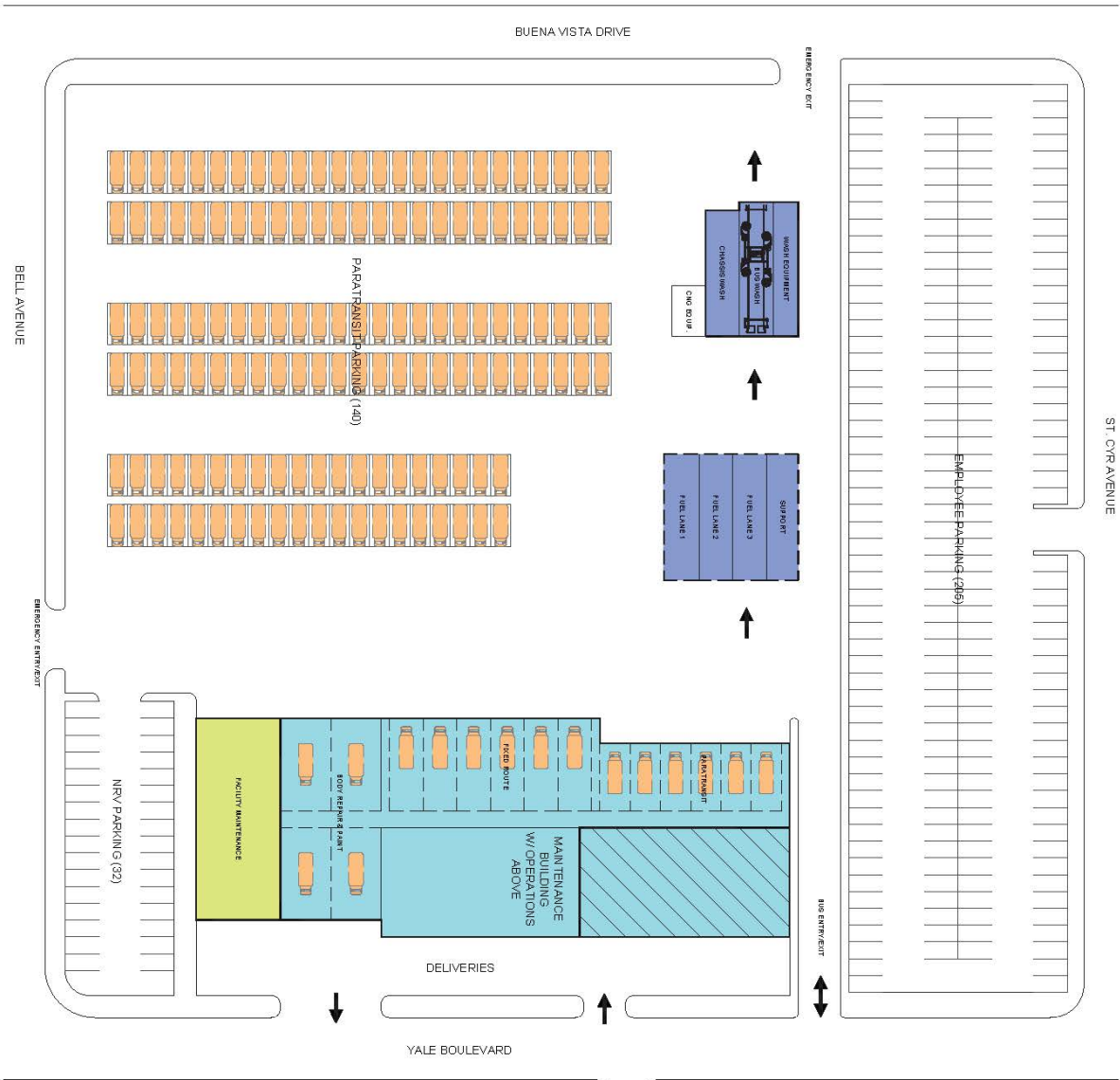

**DESIGN FLEET**

140	PARATRANSIT 25'
140	TOTAL
20	NRV

- LEGEND**
- FIXED ROUTE 40'
  - FIXED ROUTE 60'
  - PARATRANSIT 25'
  - VEHICLE MAINTENANCE
  - OPERATIONS (GROUND)
  - OPERATIONS (ABOVE)
  - FUEL & WASH
  - FACILITY MAINTENANCE

DRAWING NUMBER <b>3(E)C</b>	DRAWING TITLE <b>OPTION 3(E)C NEW FACILITIES EAST W/ OPS ABOVE MAINT</b>	 <small>16000 PARK ROW SUITE 500 HOUSTON, TEXAS 77056 TEL (281) 595-0900 FAX (281) 738-9066</small>	PROJECT TITLE <b>ABQ RIDE YALE MAINTENANCE FACILITY ASSESSMENT</b>	PROJECT NO.	33722A
				DRAWN BY	MM
				SCALE	25x44 1/32" 11x17 1/64"

THIS PAGE LEFT INTENTIONALLY BLANK

## OPTION ASSESSMENT

The matrices on the following pages provide a summary of the options and sub-options along with the advantages and disadvantages associated with each scenario:

# CONCEPT DESIGN

## CONCEPT DESIGN OPTION ANALYSIS

	OPTION 1: 40' BUS & PARATRANSIT	OPTION 2: 60' BUS, 40' BUS, & PARATRANSIT	OPTION 3: PARATRANSIT ONLY
ADVANTAGES	<ol style="list-style-type: none"> <li>1. Provides flexibility to serve multiple vehicle types (40' bus and paratransit).</li> <li>2. Simpler site configurations for new layouts due to smaller maintenance facility footprint.</li> <li>3. Reduced costs compared to options serving 60' buses via smaller facility footprint.</li> <li>4. Reduced costs compared to options serving 60' buses via lower cost lifts and paint booths for 40' vehicles.</li> <li>5. Paratransit may reduce deadhead from shorter run distances if operated from Yale. <i>(ABQ Ride to verify)</i></li> </ol>	<ol style="list-style-type: none"> <li>1. Maximum future-proofing and flexibility due to ability to serve all vehicle types in ABQ Ride fleet.</li> <li>2. Paratransit may reduce deadhead from shorter run distances if operated from Yale. (Info to be supplied by ABQ Ride Operations - vehicle deadhead is not part of this study)</li> <li>2. 60' BRT vehicles may reduce deadhead from shorter run distances if operated from Yale. <i>(ABQ Ride to verify)</i></li> </ol>	<ol style="list-style-type: none"> <li>1. Creates a specialized facility to focus on paratransit vehicles and segregate specialty tools and parts associated with paratransit operations and maintenance.</li> <li>2. Simpler site configurations for new layouts due to smaller maintenance facility footprint, however, the footprint could be further reduced by reducing length of longer bays that provide flexibility to maintain 40' buses.</li> <li>3. Reduced costs compared to options serving 60' buses via smaller facility footprint.</li> </ol>
DISADVANTAGES	<ol style="list-style-type: none"> <li>1. Reduced flexibility due to inability to service 60' buses.</li> <li>2. Paratransit may incur higher deadhead from increased run distances if operated from Yale. <i>(ABQ Ride to verify)</i></li> </ol>	<ol style="list-style-type: none"> <li>1. More difficult for site configuration and circulation due to larger maintenance facility footprint.</li> <li>2. Increased costs due to larger facility footprint to accommodate 60' buses.</li> <li>3. Increased costs due to lifts and paint booth required to service 60' buses.</li> <li>4. 60' BRT vehicles may incur higher deadhead from increased run distances if operated from Yale. <i>(ABQ Ride to verify)</i></li> </ol>	<ol style="list-style-type: none"> <li>1. Reduced flexibility due to inability to service 60' buses.</li> <li>2. Reduced flexibility due to inability to lift 40' buses without additional lift purchases and changes to bay layouts. (Lube reels, exhaust, etc.)</li> <li>3. Paratransit may incur higher deadhead from increased run distances if operated solely from Yale. <i>(ABQ Ride to verify)</i></li> </ol>



## CONCEPT DESIGN SUB-OPTION ANALYSIS

	SUB-OPTION A: REUSE EXISTING OPERATIONS	SUB-OPTION B: NEW STAND-ALONE OPERATIONS BUILDING	SUB-OPTION C: NEW OPERATIONS ABOVE MAINTENANCE
ADVANTAGES	<ol style="list-style-type: none"> <li>1. Reduced costs from reusing the existing operations facility.</li> <li>2. Less interruption to operations due to reuse of existing operations facility.</li> </ol>	<ol style="list-style-type: none"> <li>1. Increased site space and employee parking due to reduced building footprint.</li> <li>2. Operational efficiency gains from properly designed and sized spaces for transit operations.</li> <li>3. Cost savings over time from improved / sustainable building systems with lower operational costs over the facility's lifetime.</li> <li>4. Improves site circulation for transit vehicle traffic due to better building location and proper footprint.</li> </ol>	<ol style="list-style-type: none"> <li>1. Maximizes site space and employee parking due to reduced ground level footprint.</li> <li>2. Operational efficiency gains from properly designed and sized spaces for transit operations.</li> <li>3. Cost savings over time from improved / sustainable building systems with lower operational costs over the facility's lifetime.</li> <li>4. Improves site circulation for transit vehicle traffic due to removing operations building from ground level footprint.</li> <li>5. Reduced construction costs due to shared systems (shared walls, HVAC, etc.)</li> </ol>
DISADVANTAGES	<ol style="list-style-type: none"> <li>1. Reduces flexibility and efficiency for transit vehicle site circulation due to oversized footprint and non-ideal location of existing Operations Building.</li> <li>2. Operations continues to occupy an oversized space.</li> <li>3. Higher operational costs due to old construction and non-sustainable building systems for the entire lifetime of the facility.</li> </ol>	<ol style="list-style-type: none"> <li>1. Higher costs than reusing existing facilities.</li> <li>2. Loss of site space for employee parking due to new building footprint.</li> <li>3. Higher construction costs due to required systems for stand-alone building (Exterior walls, HVAC, etc.)</li> </ol>	<ol style="list-style-type: none"> <li>1. Higher costs than reusing existing facilities.</li> </ol>